

TOSHIBA



OWNER'S MANUAL

Integrated High Definition DLP™ Projection Television

COLORSTREAM® HD THEATERWIDE HD



HDMI



Note: High definition programming is required to view High Definition TV broadcasts. Please contact your cable or satellite provider.

Owner's Record

The model number and serial number are on the back of your TV. Record these numbers in the spaces below. Refer to these numbers whenever you communicate with your Toshiba dealer about this TV.

Model number:

Serial number:

42HM66

Dear Customer,

Thank you for purchasing this Toshiba TV. This manual will help you use the many exciting features of your new TV. Before operating the TV, please read this manual completely, and keep it nearby for future reference.

Safety Precautions

WARNING: TO REDUCE THE RISK OF FIRE OR ELECTRIC SHOCK, DO NOT EXPOSE THIS APPLIANCE TO RAIN OR MOISTURE.



WARNING
RISK OF ELECTRIC SHOCK!
DO NOT OPEN.



WARNING: TO REDUCE THE RISK OF ELECTRIC SHOCK, DO NOT REMOVE COVER (OR BACK). NO USER-SERVICEABLE PARTS INSIDE. REFER SERVICING TO QUALIFIED SERVICE PERSONNEL. (This does not apply to "Lamp unit replacement and care" on pages 32-33.)



The lightning flash with arrowhead symbol, within an equilateral triangle, is intended to alert the user to the presence of uninsulated "dangerous voltage" within the product's enclosure that may be of sufficient magnitude to constitute a risk of electric shock to persons.



The exclamation point within an equilateral triangle, is intended to alert the user to the presence of important operating and maintenance (servicing) instructions in the literature accompanying the appliance.

Lamp Unit Replacement

CAUTION: HOT SURFACE!
Touching the lamp before it has cooled will result in severe burns. ALLOW THE LAMP TO COOL FOR AT LEAST ONE (1) HOUR BEFORE REPLACING IT.



The lamp in this product has a limited service life. The length of service life varies depending on product use and user settings. If you use the lamp beyond its service life:

- you may notice a reduction in the colors and/or brightness of the picture, at which time you should replace the lamp unit; and
- the strength of the quartz glass in the lamp will be reduced and the lamp may rupture. If the lamp ruptures, the TV will not operate until the lamp unit is replaced.

Dispose of the used lamp unit by the approved method for your area.

See "Lamp unit replacement and care" on pages 32-33.



Note: The lamp unit contains mercury. Disposal of mercury may be regulated due to environmental considerations. For disposal or recycling information, contact your local authorities or the Electronic Industries Alliance (www.eiae.org).



NOTE: NEVER CONNECT THIS TV TO A PERSONAL COMPUTER (PC).
THIS TV IS NOT INTENDED FOR USE WITH A PC.

NOTICE OF POSSIBLE TV STAND INSTABILITY

CAUTION: This television is for use only with the Toshiba stand listed below. Use with other carts or stands is capable of resulting in instability causing possible injury.

Television	Stand Model
42HM66	ST4266

NOTE TO CATV INSTALLERS IN THE U.S.A.

This is a reminder to call the CATV system installer's attention to Article 820-40 of the U.S. NEC, which provides guidelines for proper grounding and, in particular, specifies that the cable ground shall be connected to the grounding system of the building, as close to the point of cable entry as practical. For additional antenna grounding information, see items 27 and 28 on page 4.

Child Safety

It Makes A Difference Where Your TV Stands

Congratulations on your purchase!

As you enjoy your new TV, keep these safety tips in mind:

**The Issue**

- If you are like most consumers, you have a TV in your home. Many homes, in fact, have more than one TV.
- The home theater entertainment experience is a growing trend, and larger TVs are popular purchases; however, they are not always supported on the proper TV stands.
- Sometimes TVs are improperly secured or inappropriately situated on dressers, bookcases, shelves, desks, audio speakers, chests, or carts. As a result, TVs may fall over, causing unnecessary injury.

**Toshiba Cares!**

- The consumer electronics industry is committed to making home entertainment enjoyable and safe.
- The Consumer Electronics Association formed the Home Entertainment Support Safety Committee, comprised of TV and consumer electronics furniture manufacturers, to advocate children's safety and educate consumers and their families about television safety.

Tune Into Safety

- One size does NOT fit all! Use appropriate furniture large enough to support the weight of your TV (and other electronic components).
- Use appropriate angle braces, straps, and anchors to secure your furniture to the wall (but never screw anything directly into the TV).
- Carefully read and understand the other enclosed instructions for proper use of this product.
- Do not allow children to climb on or play with furniture and TVs.
- Avoid placing any item on top of your TV (such as a VCR, remote control, or toy) that a curious child may reach for.
- Remember that children can become excited while watching a program and can potentially push or pull a TV over.
- Share our safety message about this hidden hazard of the home with your family and friends. Thank you!



2500 Wilson Blvd.
Arlington, VA 22201 U.S.A.
Tel. 703-907-7600 Fax 703-907-7690
www.CE.org

CEA is the Sponsor, Producer and Manager of the International CES®

Important Safety Instructions

- 1) **Read these instructions.**
 - 2) **Keep these instructions.**
 - 3) **Heed all warnings.**
 - 4) **Follow all instructions.**
-
- 5) **Do not use this apparatus near water.**
-
- 6) **Clean only with a dry cloth.**
-
- 7) **Do not block any ventilation openings.** Install in accordance with the manufacturer's instructions.
-
- 8) **Do not install near any heat sources** such as radiators, heat registers, stoves, or other apparatus (including amplifiers) that produce heat.
-
- 9) **Do not defeat the safety purpose of the polarized or grounding type plug.** A polarized plug has two blades with one wider than the other. A grounding type plug has two blades and a third grounding prong. The wide blade or the third prong are provided for your safety. If the provided plug does not fit into your outlet, consult an electrician for replacement of the obsolete outlet.
-
- 10) **Protect the power cord** from being walked on or pinched, particularly at plugs, convenience receptacles, and the point where it exits the apparatus.
-
- 11) **Only use attachments/accessories specified by the manufacturer.**
-
- 12) **Use only with the cart, stand, tripod, bracket, or table specified by the manufacturer, or sold with the apparatus.** When a cart is used, use caution when moving the cart/apparatus combination to avoid injury from tip-over.
-
- 13) **Unplug this apparatus during lightning storms or when unused for long periods of time.**
-
- 14) **Refer all servicing to qualified service personnel.**
 Servicing is required when the apparatus has been damaged in any way, such as power-supply cord or plug is damaged, liquid has been spilled or objects have fallen into the apparatus, the apparatus has been exposed to rain or moisture, does not operate normally, or has been dropped.
-
- 14a) Item 14 does not apply to "Lamp unit replacement and care" on pages 32-33.
 - 14b) **CAUTION:** If the TV is dropped and the cabinet or enclosure surface has been damaged or the TV does not operate normally, take the following precautions:
 - ALWAYS turn off the TV and unplug the power cord to avoid possible electric shock or fire.
 - To prevent personal injury, never handle the damaged television.
 - ALWAYS contact a service technician to inspect the TV any time it has been damaged or dropped.
-
- 15) **CAUTION:**
 - To reduce the risk of electric shock, do not use the polarized plug with an extension cord, receptacle, or other outlet unless the blades can be inserted completely to prevent blade exposure.
 - To prevent electric shock, match wide blade of plug to wide slot; fully insert.

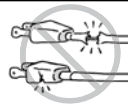
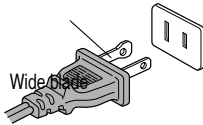



- 16) **WARNING:** This product contains a lamp to project the picture, and requires special safety precautions:
 - See pages 32-33 for instructions on lamp unit replacement and care.
 - **DO NOT attempt to service this product except as specified on pages 32-33.** The only user-serviceable item in this product is the lamp unit.

Installation, Care, and Service

Installation

Follow these recommendations and precautions and heed all warnings when installing your TV:

- 17) Never modify this equipment. Changes or modifications may void: a) the warranty, and b) the user's authority to operate this equipment under the rules of the Federal Communications Commission.
-
- 18)  **DANGER: RISK OF SERIOUS PERSONAL INJURY, DEATH, OR EQUIPMENT DAMAGE!** Never place the TV on an unstable cart, stand, or table. The TV may fall, causing serious personal injury, death, or serious damage to the TV. 
-
- 19) Never place or store the TV in direct sunlight; hot, humid areas; areas subject to excessive dust or vibration; or locations with temperatures at or below 41°F (5°C)
-
- 20) Always place the TV on the floor or a sturdy, level, stable surface that can support the weight of the unit.
-
- 21) Never expose the apparatus to dripping or splashing or place items such as vases, aquariums, any other item filled with liquid, or candles on top of the TV.
-
- 22) Always place the back of the television at least one (1) inch away from any vertical surface (such as a wall) to allow proper ventilation.
-
- 23) Never block or cover the slots or openings in the TV cabinet back, bottom, and sides. Never place the TV:
 - on a bed, sofa, rug, or similar surface;
 - too close to drapes, curtains, or walls; or
 - in a confined space such as a bookcase, built-in cabinet, or any other place with poor ventilation.
 The slots and openings are provided to protect the TV from overheating and to help maintain reliable operation of the TV.
-
- 24) Never allow anything to rest on or roll over the power cord, and never place the TV where the power cord is subject to wear or abuse.
-
- 25) Never overload wall outlets and extension cords.
-
- 26) Always operate this equipment from a 120 VAC, 60 Hz power source only.

(continued on next page)

Installation *(continued from previous page)*

- 27) Always make sure the antenna system is properly grounded to provide adequate protection against voltage surges and built-up static charges (see Section 810 of the National Electric Code).

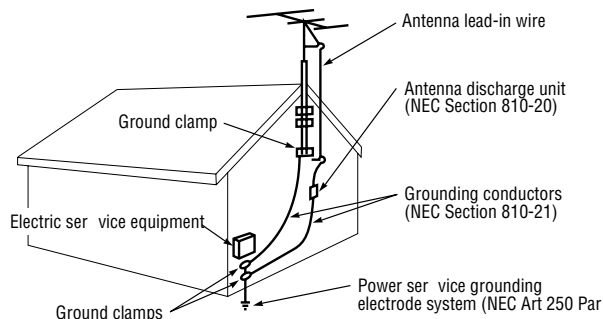



- 28)  **DANGER: RISK OF SERIOUS PERSONAL INJURY OR DEATH!**

- Use extreme care to make sure you are never in a position where your body (or any item you are in contact with, such as a ladder or screwdriver) can accidentally touch overhead power lines. Never locate the antenna near overhead power lines or other electrical circuits.
- Never attempt to install any of the following during lightning activity: a) an antenna system; or b) cables, wires, or any home theater component connected to an antenna or phone system.

Care



For better performance and safer operation of your TOSHIBA TV, follow these recommendations and precautions:

- 29) Always sit approximately 10–25 feet away from the TV and as directly in front of it as possible. The picture can appear dull if you sit too far to the left or right of the TV, or if sunlight or room lights reflect on the screen. Turn the TV off to check for reflections on the screen, and then remove the source of reflections while viewing the TV.
- 30) Always unplug the TV before cleaning. Never use liquid or aerosol cleaners. Clean only with a soft, dry cloth. Do not spray volatile compounds, such as insecticide, on the cabinet. This may discolor or damage the cabinet.
- 31)  **WARNING: RISK OF ELECTRIC SHOCK!** Never spill liquids or push object of any kind into the TV cabinet slots. 
- 32) If the air temperature rises suddenly (for example, when the TV is first delivered), condensation may form on the lenses. This can make the picture appear distorted or the color appear faded. If this happens, turn off the TV for 6 to 7 hours to allow the condensation to evaporate.

Care *(continued from previous column)*

- 33) For added protection of your TV from lightning and power surges, always unplug the power cord and disconnect the antenna from the TV if you leave the TV unattended or unused for long periods of time.
- 34) During normal use, the TV may make occasional snapping or popping sounds. This is normal, especially when the unit is being turned on or off. If these sounds become frequent or continuous, unplug the power cord and contact a Toshiba Authorized Service Center.
- 35) **Special care for Texas Instruments Digital Light Processing™ (DLP) lamp units:**
- The lamp in this product has a limited service life. The length of service life varies depending on product use or user settings. If you use the lamp beyond its service life:
 - you may notice a reduction in the colors and/or brightness of the picture, at which time you should replace the lamp unit; and
 - the strength of the quartz glass in the lamp will be reduced and the lamp may rupture. If the lamp ruptures, the TV will not operate until the lamp unit is replaced.
- See “Lamp unit replacement and care” on pages 32-33.
- Dispose of the used lamp unit by the approved method for your area.
 -  The lamp unit contains mercury. Disposal of mercury may be regulated due to environmental considerations. For disposal or recycling information, please contact your local authorities or the Electronic Industries Alliance (www.eiae.org).

Service

- 36) **WARNING: RISK OF ELECTRIC SHOCK!**  Never attempt to service the TV yourself, except as specified on pages 32-33.  Opening and removing the covers may expose you to dangerous voltage or other hazards. Failure to follow this WARNING may result in death or serious injury. Refer all servicing not specified in this manual to a Toshiba Authorized Service Center.
- 37) If you have the TV serviced:
- Ask the service technician to use only replacement parts specified by the manufacturer.
 - Upon completion of service, ask the service technician to perform routine safety checks to determine that the TV is in safe operating condition.
- 38) When the TV reaches the end of its useful life, ask a qualified service technician to properly dispose of the TV.
- Note:** *The lamp unit contains mercury. Disposal of mercury may be regulated due to environmental considerations. Dispose of the used lamp unit by the approved method for your area.*
- For disposal or recycling information, please contact your local authorities or the Electronic Industries Alliance (www.eiae.org).*

Digital Light Processing, DLP™ and the DLP medallion are trademarks of Texas Instruments.

Handling the TV

Hold the TV as indicated in the illustrations below.

To ensure balance and avoid damage, ALWAYS have at least two people carry the TV.

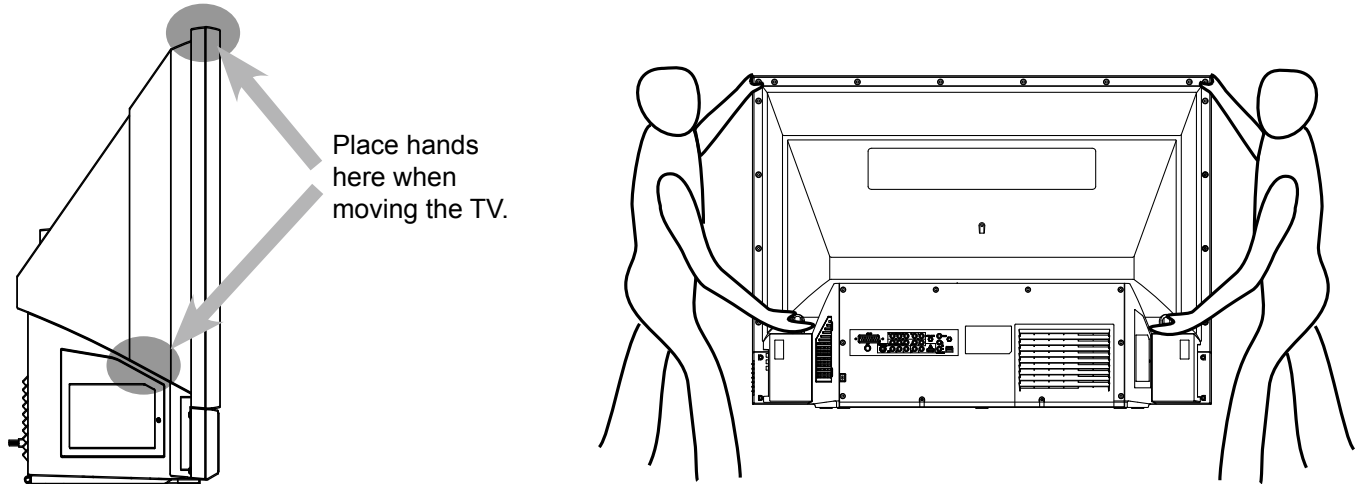

Installing the TV

Attaching the TV to a wall or pillar

1. Securely attach a sturdy cord or chain to each wire clip on the rear of the TV.
2. Attach the cord or chain to a wall or pillar. Make sure the TV is at least 1 in minimum from the wall or pillar.

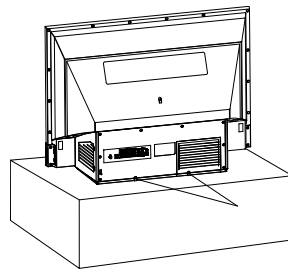

Recommended TV Stand:
Toshiba Stand Model ST4266

Side view

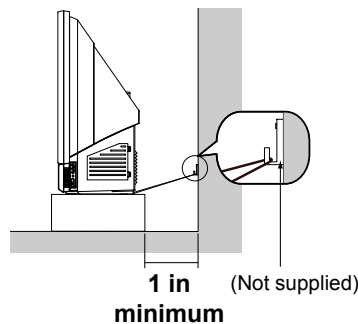

Top view

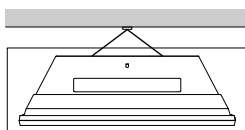

Important notes about your DLP™ projection TV

- 1) The light source for this TV is a projection lamp unit with a limited service life. When the lamp wears out, the picture may become dark or black or the lamp may fail, at which time you must replace the lamp unit. See "Lamp unit replacement and care" on pages 32-33.
- 2) Each time you turn on the TV, it may take several minutes to go from no picture to full picture brightness.
- 3) The TV's display is manufactured using an extremely high level of precision technology; however, an occasional pixel (dot of light) may show constantly on the screen. This is a structural property of DLP™ projection TV technology, and is not a sign of malfunction. Such pixels are not visible when the picture is viewed from a normal viewing distance (see item 29 on page 4).
- 4) Depending on the media you are viewing, it is possible, although unlikely, that a limited number of viewers may see a "rainbow effect" on the screen, which can, in rare instances, result in eye fatigue. This is a rare occurrence related to technology of this type, and is not a sign of TV malfunction.
- 5) Always sit approximately 10–25 feet away from the TV and as directly in front of it as possible. The picture quality may be affected by your viewing position and length of viewing time. If you sit too closely to the TV for too long, you may suffer from eye fatigue. See item 29 on page 4.
- 6)  This TV contains several cooling fans to moderate the internal temperature. You may be able to hear the fans for several minutes after the TV is turned off. This is a function of the Quick Restart Low Power Shutdown mode and is not a sign of TV malfunction. You can set the Quick Restart feature to stop the fans as soon as the TV is turned off. See "Setting the Quick Restart feature" on page 19.
- 7) The green and orange LED on the lower right corner of the TV screen indicate your TV's current status. If either light flashes, see "LED indications" on page 31 for details.
- 8) Review all safety and operating information in this owner's manual before you use your TV.
- 9) If you unplug the power cord while the TV is on, when you plug the power cord in again then turn on the DC power, the lamp will automatically retry up to several times. This is normal and is not a sign of malfunction.

Contents

1. Important information	2	6. Power ON / OFF	19
<i>Important Safety Information</i>	2-4	<i>Power ON / OFF</i>	19
<i>Handling the TV</i>	5	<i>Setting the Quick Restart™ Feature</i>	19
<i>Important notes about your DLP™ projection TV</i>	6		
2. Introduction	7	7. Using the TV's features	20
<i>Welcome to Toshiba</i>	7	<i>Navigating the menus</i>	20
		<i>Programming channels into the TV's channel memory</i>	20
		<i>Using the IMAGE SETTING menu</i>	21
		<i>Using the AUDIO SETTING menu</i>	21
		<i>Using the DISPLAY SETTING menu</i>	22
		<i>Using the TV/DTV SETTING menu</i>	24
		<i>Using the PARENTAL CONTROL menu</i>	25
		<i>Using the GENERAL SETTING menu</i>	26-27
		<i>DTV information</i>	28
3. Connecting and checking the Antenna	8	8. Appendix	29
<i>Connecting an antenna cable</i>	8	<i>Specifications</i>	29
<i>Cable TV (CATV / DTV) connection</i>	8	<i>Video Input Format</i>	29
		<i>Troubleshooting</i>	30-31
		<i>Lamp unit replacement and care</i>	32-33
		<i>Limited United States Warranty</i>	34
		<i>Limited Canada Warranty</i>	35
4. Controls and connections	9		
<i>Side Panel Connections</i>	9		
<i>Back Panel Connections</i>	10		
5. Using the remote control	11		
<i>Installing the remote control batteries</i>	11		
<i>Remote control effective range</i>	11		
<i>Remote control functions</i>	12-13		
<i>Programming the universal remote control</i>	14		
<i>Device program codes</i>	15-18		

Welcome to Toshiba

Thank you for purchasing this Toshiba TV, one of the most innovative DLP™ projection TVs on the market. The goal of this manual is to guide you through setting up and operating your TV as quickly as possible.

- This manual applies to models 42HM66. Before you start reading, check the model number on the back of your TV.
- Instructions in this manual are based on using the remote control. You also can use the controls on the TV side control panel if they have the same name as those referred to on the remote control.
- The side panel (page 9) and back panel (page 10) provide terminals for connecting other equipment to your TV.
- Please read all safety and operating instructions in this manual carefully, and keep this manual for future reference.

Features of your new TV

The following are just a few of the many exciting features of your new Toshiba wide screen, integrated HD DLP™ projection TV:

- Integrated digital tuning (8VSB ATSC and QAM) eliminates the need for a separate digital converter set-top box (in most cases).
- One HDMI (DVI) digital, high-definition multimedia interface (page 10).
- Two sets of ColorStream® HD high-resolution component video inputs (pages 10).
- Dolby Digital* audio technology.
- Digital Audio Out Coaxial audio connection (page 10).
- Double-window PIP (page 22), PBP, POP and Swap (page 23) features.

* Manufactured under license from Dolby Laboratories. "Dolby" and the double-D symbol are trademarks of Dolby Laboratories.

Connecting an antenna cable

1. Cable without a CATV Converter
2. VHF/UHF Combination Antenna

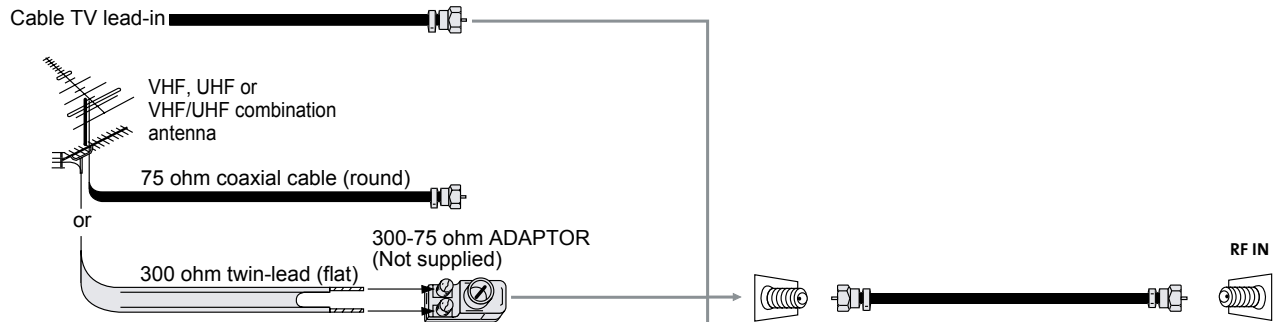

3. Separate VHF/UHF Antenna

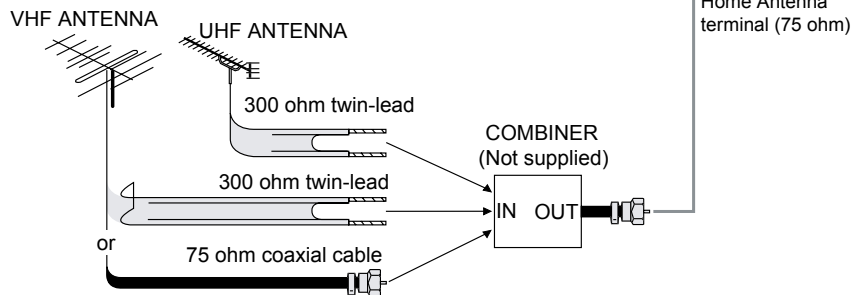

Cable TV (CATV/DTV) connection

- A 75 ohm coaxial cable (F-type) connector is built into the TV for easy hookup.

Note:

When connecting 75 ohm (RF) coaxial cable to the TV, **HAND-TIGHTEN** only.

NEVER use tools to tighten F-type connectors. Using tools may damage the TV. This type of damage is **NOT COVERED BY YOUR WARRANTY.**

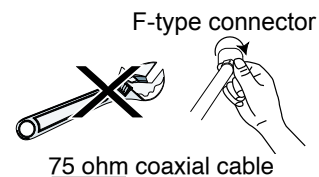

- Some cable TV companies offer “premium pay channels.” Since the signals of these premium pay channels are scrambled, a cable TV converter/descrambler is generally provided to the subscriber by the cable TV company. This converter/descrambler is necessary for normal viewing of the scrambled channels.

Set your TV on channel 3 or 4 (whichever channel is used by your cable TV company). For more specific instructions on installing cable TV, consult your cable TV company.

Side panel controls

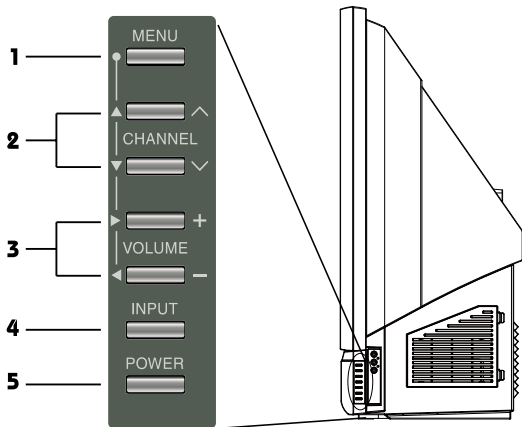

1. MENU — Opens and closes the menu system.
2. CHANNEL ▲▼ — When no menu is on-screen, change the channel. When a menu is on-screen, function as up/down navigation.
3. VOLUME ◀▶ — When no menu is on-screen, adjust the volume. When a menu is on-screen, function as left/right navigation.
4. INPUT — Changes the image signal source: TV, AV1, S-Video, ColorStream HD-1, ColorStream HD-2, HDMI.

Front panel

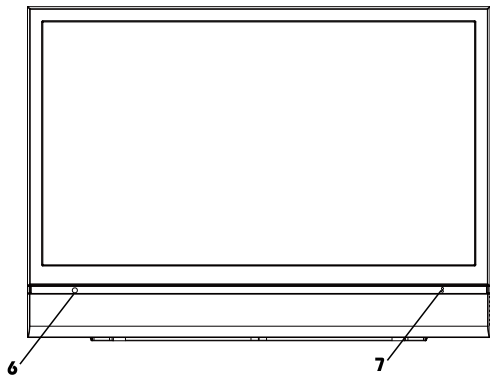

6. IR sensor — Receives infrared signals from the remote control.
7. Lamp/power status — LED indicators for lamp and power (see page 31).

Side panel connections

The side panel A/V connections are referred to as "VIDEO-2."

To view the source connected to VIDEO-2, press INPUT on the remote control or TV and select "VIDEO-2."

Note: The TV's INPUT key is on the side panel (see "Side panel controls," above).

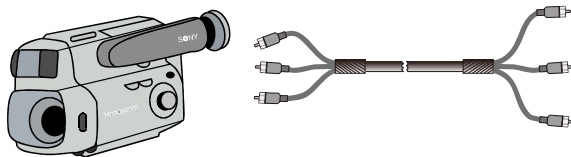

(Cables are not supplied)

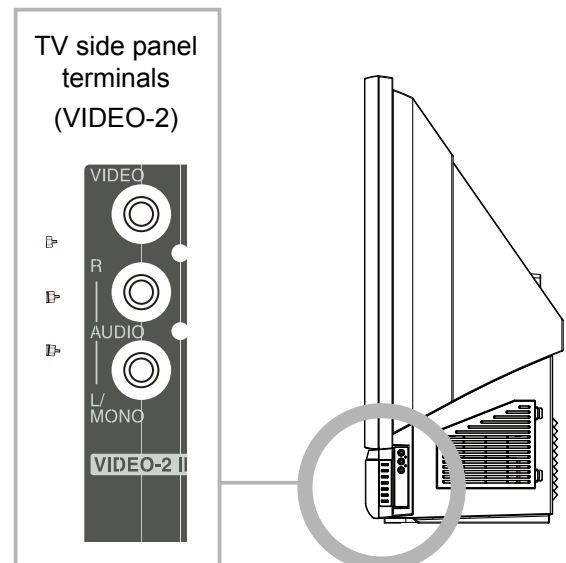

Back panel connections

To view a source connected to one of the inputs on the back panel, press INPUT on the side panel to select the applicable input: TV, AV1, S-Video, ColorStream HD-1, ColorStream HD-2, or HDMI.

Note:

- The TV's INPUT key is on the side panel (not the front).
- For details on the video output requirements of your other devices, refer to the owner's manuals for those devices.
- Cables are not supplied.

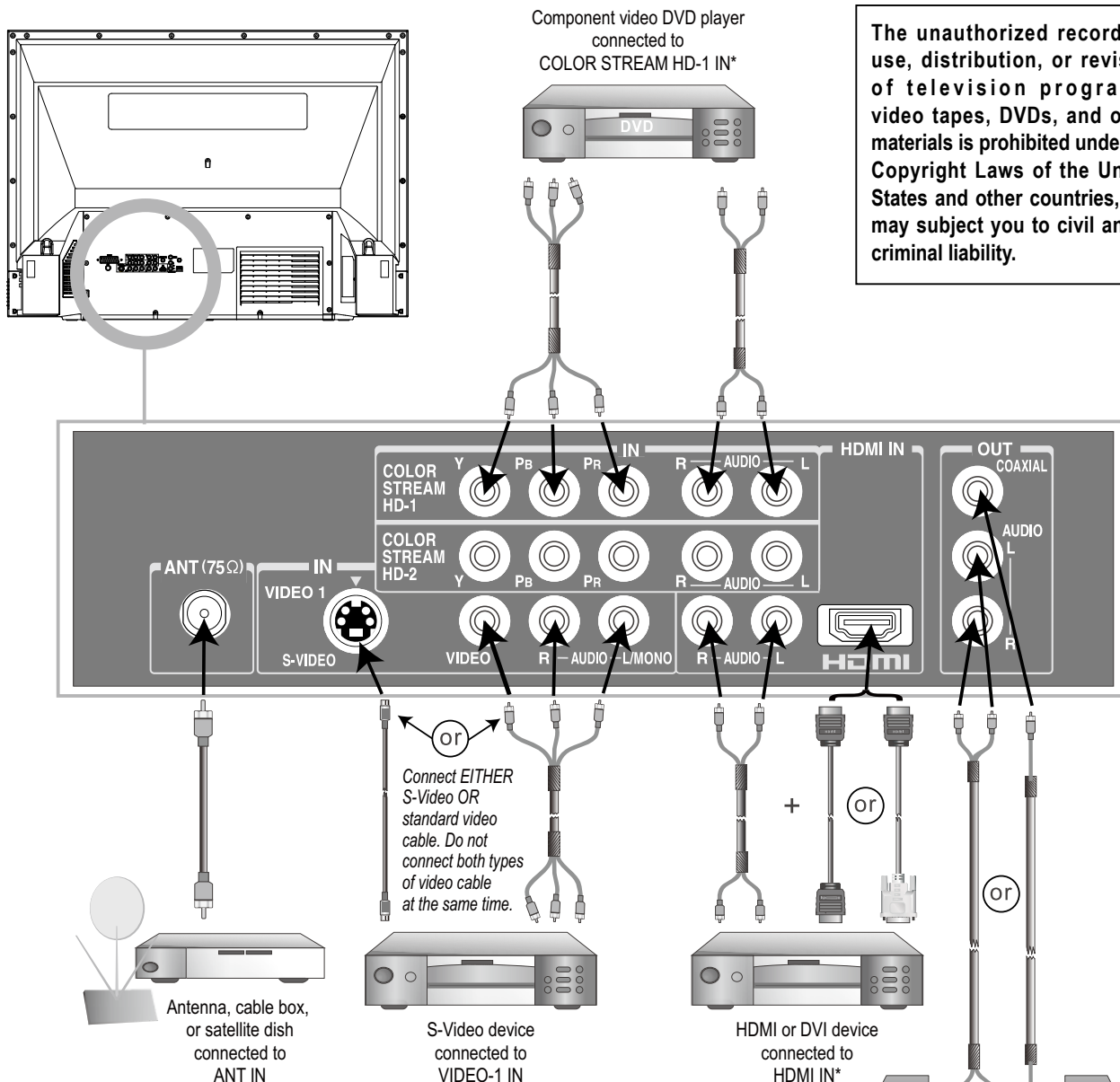

* You can connect a component video-compatible device to either set of ColorStream® inputs on the TV back panel—ColorStream HD-1 or ColorStream HD-2.

** For proper operation, it is recommended that you use as short an HDMI cable as possible (shorter than 16.4 ft (5m)). HDMI cable transfers both video and audio; therefore, separate analog audio cables are not required. Some CDVs (video CDs) may not output digital audio signals, in which case you may hear sound by connecting analog audio cables. Connecting a DVI device requires an HDMI-to-DVI converter cable and analog audio cables. Because this is an evolving technology, it is possible that some devices may not operate properly with the TV.

HDMI, the HDMI logo and High-Definition Multimedia Interface are trademarks or registered trademarks of HDMI Licensing LLC.

Installing the remote control batteries

1. Remove the battery cover from the back of the remote control.
2. Insert two "AA" size batteries, making sure to match the + and – signs on the batteries with the + and – symbols inside the battery compartment.
3. Reinsert the battery cover on the back of the remote control until the tab snaps.

Caution:

Never throw batteries into a fire.

Note:

- Be sure to use "AA" size batteries.
- Dispose of batteries in a designated disposal area.
- Batteries should always be disposed of with the environment in mind. Always dispose of batteries in accordance with applicable laws and regulations.
- If the remote control does not operate correctly, or if the operating range becomes reduced, replace batteries with new ones.
- When necessary to replace batteries in the remote control, always replace both batteries with new ones. Never mix battery types or use used and new batteries in combination.
- Always remove the batteries from the remote control if they are dead or if the remote control is not to be used for an extended period of time. This will prevent acid from leaking into the battery compartment.



Remote control effective range

The effective range of the remote control's IR (infrared) sensor is illustrated at right.

For optimum performance, aim the remote control directly at the TV's IR sensor, and make sure there are no obstructions between the remote control and the TV.

Note: Avoid placing the remote control's IR sensor in bright light, which may reduce its receiving sensitivity.

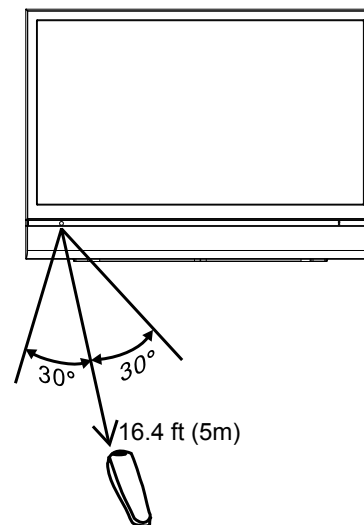

Remote control functions

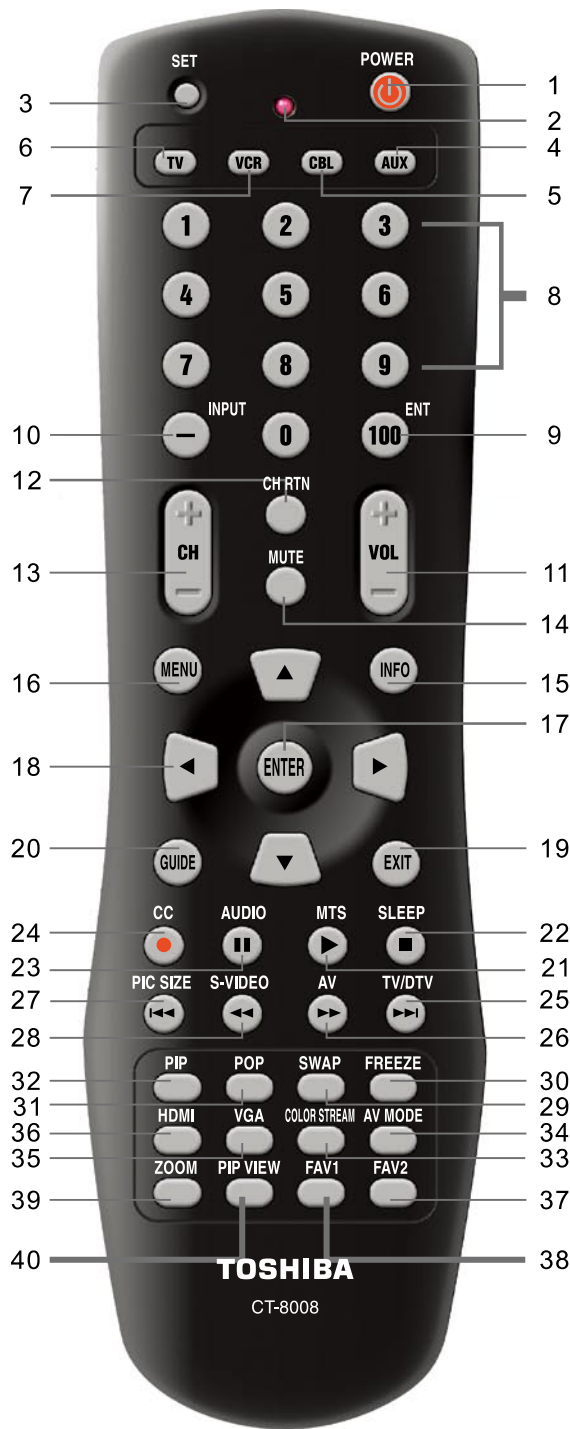

Button name	Function
1. POWER	Turns the TV ON and OFF.
2. LED	Blinks when the remote control is sending a signal to the TV or is being programmed.
3. SET	Starts all programming sequences.
4. AUX	Puts the remote control in AUXILIARY mode (to operate a programmed device).
5. CBL	Puts the remote control in CABLE mode (to operate a programmed cable TV set-top box) or SATELLITE mode (to operate a programmed satellite TV set-top box).
6. TV	Puts the remote control in TV mode (preprogrammed to operate this TV).
7. VCR	Puts the remote control in VCR mode (to operate a programmed VCR).
8. Channel Numbers	Select a channel or input a password.
9. 100/ENT	a. In TV mode, enters a channel number greater than 100. b. In other modes, functions as ENTER.
10. -/INPUT	a. In TV mode, enters a decimal point for DTV channel numbers. b. In other modes, functions as INPUT.
11. VOL (+/-)	Turns the volume up/down.
12. CH RTN	Tunes the previously viewed channel. (Will not switch between TV and DTV channels).
13. CH (+/-)	Changes the channel up/down.
14. MUTE	Turns the sound ON and OFF.
15. INFO	Displays the current video and audio source (and channel number in TV mode).
16. MENU	Opens the on-screen display (OSD) menus.
17. ENTER	Selects options in the menus.
18. ▲▼◀▶	Navigate the menus.
19. EXIT	Closes a menu or program guide, or exits the device.
20. GUIDE	Turns the program guide ON and OFF in DTV mode (see page 30).
21. MTS / Play	a. In TV mode, toggles among STEREO, SAP, and MONO audio. b. In DTV mode, toggles among ENGLISH, FRENCH, and SPANISH OSD languages. c. In other modes, plays the CD player, DVD player, or VCR.

Note :

If the remote control does not work, press the TV button and try again.

Remote control functions

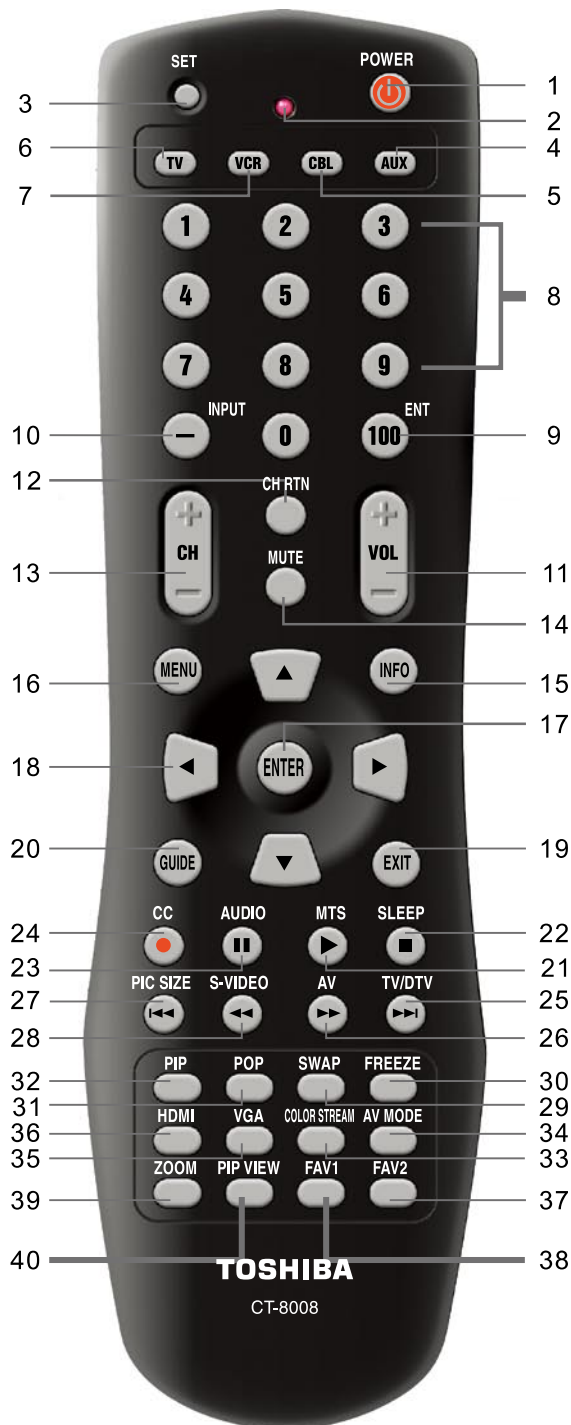

Button name	Function
22. SLEEP/STOP	a. In TV mode, selects the sleep options. b. In other modes, stops a CD player, DVD player, or VCR.
23. AUDIO/Pause	a. (AUDIO mode is not available.) b. Pauses the CD player, DVD player, or VCR when the component is activated with the remote control.
24. CC/Record	a. In TV mode, selects closed caption options. b. In VCR mode, functions as RECORD.
25. TV/DTV/Skip Forward	a. In TV mode, selects TV or Digital TV mode. b. In other modes, skips forward the CD player, DVD player, or VCR.
26. AV/Forward	a. In TV mode, selects AV1 or AV2. b. In other modes, forwards the CD player, DVD player, or VCR.
27. PIC SIZE/Skip Reverse	a. In TV mode, cycles through standard and widescreen viewing modes. b. In other modes, skip reverses the CD player, DVD player, or VCR.
28. S-video/Reverse	a. In TV mode, press the "S-video" button to select the S-video input. b. In other modes, rewinds the CD player, DVD player, or VCR.
29. Swap	Swaps the inputs from the main and PiP or POP picture mode.
30. Freeze	"Freezes" the current screen. Press again to continue playing. If no key is pressed within one minute, play will automatically resume.
31. POP	Activates the picture-on-picture mode.
32. PIP	Activates the picture-in-picture mode.
33. COLOR STREAM	press the "color stream" button to select the color stream input.
34. AV Mode	(No function.)
35. VGA	(No function.)
36. HDMI	press the "HDMI" button to select the HDMI input.
37. FAV2	(No function.)
38. FAV1	(No function.)
39. ZOOM	(No function.)
40. PIP View	(No function.)

Programming the TV's universal remote control to operate your other devices

You can program the TV's remote control to operate up to four different devices—one for each mode button (TV, VCR, CBL, and AUX).

The "TV" mode button on the remote control (see item 6 on page 12) is already programmed to operate your TV. (The TV's device program code is 11369).

To program the remote control to operate another device:

1. Find the code for the other device in the "Device program codes" table on pages 15–18.
2. Manually turn on the device (using the POWER button on the device and not the remote control).
3. Press the mode button you want to program on the remote control (TV, VCR, CBL, and AUX).
4. Press and hold SET on the remote control until the LED flashes twice.
5. Use the Channel Number buttons to enter the code for your device.
 - If the LED does not flash twice, repeat steps 3–5 using another code, if there are other codes listed for your device. (If there are no other codes listed for your device, you will not be able to program the TV remote control to operate your other device and will need to use the device's remote control.)
 - If the code is accepted, the LED flashes twice after the last digit is entered.
6. Point the remote control at the device and press POWER on the remote control. If the correct code has been programmed, the device will turn off. If the device does not respond, repeat steps 3–5 using another code.
 - If the code is accepted, the LED flashes twice after the last digit is entered.
7. Repeat these steps for other devices you want to operate using the TV remote control.

Note:

- *Even after the TV remote control is programmed, it may not operate certain features on your other device. If this happens and you wish to use those features, you will need to use the device's original remote control.*
- *In some cases you may not be able to operate your device with the TV remote control. Your other device may use a code that is not recognized by the TV remote control. If this happens, use the device's remote control.*

Device program codes

Device codes for Cable TV set-top boxes

ABC	0003, 0017
Americast	0899
Bell South	0899
General Instrument	0276, 0476, 0810
Goldstar	0144
Hamlin	0009, 0273
Jerrold	0003, 0276, 0476, 0810
Memorex	0000
Philips	0305, 0317
Pioneer	0144, 0533, 0877
Pulsar	0000
Quasar	0000
Regal	0273, 0279
Runco	0000
Samsung	0144
Scientific Atlanta	0017, 0477, 0877

Device codes for TVs

Addison	10092
Admiral	10093, 10463
Advent	10761, 10842
Aiko	10092
Aiwa	11914
Akai	10812, 10702, 10030, 10672, 11903
Albatron	10700, 10843
America Action	10180
Anam	10250, 10180, 10700
Anam National	10250, 10650
Anhua	10051
AOC	10451, 10093, 10180, 10060, 10030, 10178, 10092
Apex Digital	10748, 10765, 10879, 10767, 11943
Audiovox	10451, 10180, 10875, 10092, 10623
Baile	10661
Beijing	10812, 10661
Bell & Howell	10154
BenQ	11032
Bradford	10180
Broksonic	10236, 10463, 11911, 11938, 11905, 11935, 11929
Cailing	10748
Candle	10030
Carnivale	10030
Carver	10054
Celebrity	10000
Celera	10765
Changcheng	10051, 10661
Changhong	10156, 10765, 11156, 10767
Ching Tai	10092
Chun Yun	10000, 10180, 10700, 10092, 10843
Chung Hsin	10180, 10053
Cinema	10672
Citizen	10060, 10030, 11928, 10092
Clarion	10180
Commercial-Solutions	11447, 10047
Conrowa	10156, 10145, 11156
Contec	10180
Craig	10180, 10054
Crown	10180
Curtis Mathes	10047, 10054, 10154, 10451, 10093, 10060, 10702, 10030, 10145, 10166

CXC	10180
Daewoo	10154, 10451, 10180, 10030, 10178, 10672, 11928, 10092, 10661, 11909, 10623, 10700
Dayu	10661
Dell	11080
Denon	10145
Dumont	10017
Durabrand	10463, 10180, 10178, 10171, 11034
Electroband	10000
Emerson	10154, 10236, 10463, 10180, 10178, 10171, 11944, 11909, 11929, 11905, 11928, 10623, 11911
Envision	10030
Ether	10030
Firstar	10236
Fisher	10154
Fortress	10093
Fujitsu	10809, 10853
Funai	10180, 10171, 11904
Furi	10145
Futuretech	10180
Gateway	11756, 11755
GE	11447, 10047, 11454, 10051, 10451, 10180, 10030, 10178, 11917, 10092, 11907, 11922
Gibraltar	10017, 10030
GoldStar	10154, 10030, 10178, 11926
Grunpy	10180
Haier	11034
Hallmark	10178
Hankook	10180, 10030, 10178
Harley Davidson	11904
Harman/Kardon	10054
Harvard	10180
Havermy	10093
Helios	10865
Hello Kitty	10451
Hisense	10156, 10748, 10145, 11156
Hitachi	10156, 10030, 10178, 11145, 10145, 10092, 11904, 11156
Hongmei	10093
Huafa	10145
Huari	10145
Huodateji	10051
Imperial Crown	10661
Infinity	10054
Inteq	10017
JBL	10054
JCB	10000
Jean	10156, 10051, 10236, 10092
Jensen	10761
Jiahua	10051
Jinfeng	10051
Jinxing	10054, 10156, 10145
JVC	10053, 11923, 11253
Kangli	10661
KEC	10180
Kenwood	10030
KLH	10765, 10767
Kolin	10180, 10150, 10053
KTV	10180, 10030
Kunlun	10051, 10661
LG	10060, 10030, 10178, 10856, 10700, 10025, 11904
Lloyd's	11904
LXI	10047, 10054, 10154, 10156, 10178
Magnasonic	11928, 11913

Magnavox	11454, 10054, 10030, 10706, 11931, 11254, 11913, 11904, 11944
Magnin	11907
Marantz	10054, 10030, 10704
Matsushita	10250, 10650
Maxent	11755
Megapower	10700
Megatron	10178, 10145
Memorex	10154, 10463, 10150, 10178, 11911, 11926, 11924, 11920, 11927
MGA	10150, 10030, 10178, 11907
Midland	10047, 10017, 10051
Mitsubishi	10154, 10250, 10093, 10236, 10180, 11250, 10150, 10030, 10178, 11917, 10836
Monivision	10843, 10700
Motorola	10093
MTC	10060, 10030
Mudan	10051
Multitech	10180
NAD	10156, 10178, 10866
National	10051
NEC	10154, 10156, 10051, 10053, 10030, 10178, 11704
Newave	10093, 10178, 10092
Nikko	10030, 10178, 10092
Norcent	10748, 10824
NTC	10092
Onwa	10180
Optimus	10154, 10250, 10166, 10650, 11927, 11924, 11913
Optonica	10093
Orion	10236, 10463, 11929, 11911, 11905
Panasonic	10054, 10250, 10051, 10650, 11927, 11924
Panda	10051, 10706
Penney	10047, 10156, 10051, 10060, 10030, 10178, 11926, 11907
Philco	10054, 10180, 10030, 10178
Philips	11454, 10054, 10000, 10051, 10030, 10178, 10092, 10690
Pilot	10030
Pioneer	10166, 10866, 10679
Portland	10092
Prima	10761
Princeton	10700
Prism	10051
Proscan	11447, 10047, 11922
Proton	10030, 10178
Pulsar	10017
Qingdao	10051
Quasar	10250, 10051, 11924, 10650
RadioShack	10047, 10154, 10180, 10030, 10178, 11920, 11904
RCA	11447, 10047, 11454, 10000, 10030, 10178, 11547, 11922, 11917, 10092, 11907, 11948, 10090, 10679
Realistic	10154, 10180, 10030, 10178
Rowa	10748
Runco	10017, 10030
Sampo	10154, 10093, 10030, 10178, 10171, 10700, 10650, 11755, 10092

Device program codes

Device codes for TVs

(continued from previous page)

Samsung	10154, 10156, 10060, 10812, 10702, 10030, 10178, 11060, 10814, 10092, 11903, 10090, 10766
Sansui	10463, 11904, 11935, 11929, 11911
Sanyo	10154, 10156, 10180, 10145, 11907
Sanyuan	10093
Scotch	10178
Scott	10236, 10180, 10178
Sears	10047, 10054, 10154, 10156, 10178, 10171, 11926, 11904
Shaofeng	10145
Sharp	10093, 10030, 10650, 11917
Shen Ying	10092
Shencai	10145
Sheng Chia	10093, 10236
Skygiant	10180
Skyworth	10748
Sony	11100, 10000, 10650, 11925, 11904
Soundesign	10180, 10178
Sowa	10156, 10051, 10060, 10178, 10092
Squareview	10171
SSS	10180, 10180
Studio Experience	10843
Supreme	10000
SVA	10748, 10865
Sylvania	10054, 10030, 10171, 11944, 11931
Symphonic	10180, 10171, 11913, 11904
Synco	10000, 10451, 10093, 10060, 10178, 10092
Tacico	10178, 10092
Tandy	10093
Tashiko	10092, 10650
Tatung	10054, 10154, 10156, 10051, 10060, 11156, 11756, 11254
Technics	10250, 10051
Techwood	10051
Teco	10051, 10093, 10178, 10092
Teknika	10054, 10180, 10150, 10060, 10092
Telefunken	10702
Tera	10030
Thomas	11904
Tiane	10093
TMK	10178
TNCi	10017
Tobo	10748
Toshiba	10154, 10156, 10060, 10145, 11945, 11704, 11936, 11156, 11935, 10650, 11918
Tuntex	10030, 10092
TVS	10463
V Inc.	11756, 10885, 10864
Vector Research	10030
Victor	10250, 10053, 10650
Vidikron	10054
Vidtech	10178
Viewsonic	11755, 10885, 10864
Vivitek	11369
Wards	10054, 10030, 10178, 10866, 11156
Warumaia	10661

Waycon	10156
White Westinghouse	10463, 11909, 10623
Yamaha	10030
Yapshe	10250
Zenith	10017, 10463, 10178, 11904, 11929, 11911, 11909, 10092

Device codes for VCRs

ABS	21972
Admiral	20048, 20209
Aiko	20278
Aiwa	20037, 20479
Alienware	21972
America Action	20278
High	20035
Amoisonic	20479
Anam	20162, 20037, 20240, 20278
Anam National	20162
Asha	20240
Audiovox	20037, 20278
Beaumarck	20240
Bell & Howell	20104
Broksonic	20184, 20121, 20209, 20002, 20479
Calix	20037
Canon	20035
Carver	20081
CCE	20072, 20278
Changhong	20048, 20081
Citizen	20037, 20278
Colt	20072
Craig	20037, 20047, 20240, 20072
Curtis Mathes	20060, 20035, 20162
Cybernex	20240
CyberPower	21972
Daewoo	20045, 20104, 20278
Dell	21972
Denon	20042
DirecTV	20739
Durabrand	20039, 20038
Electrohome	20037
Electroponic	20037
Emerex	20032
Emerson	20035, 20037, 20184, 20240, 20045, 20121, 20043, 20209, 20002, 20278, 20479
Fisher	20047, 20104
Fuji	20035, 20033
Fujitsu	20045
Gateway	21972
GE	20060, 20035, 20240
General	20045
Go Video	20432
GoldStar	20037, 20209, 20038, 20225
Haojie	20240
Harman/Kardon	20081, 20038
Harwood	20072
Hewlett Packard	21972
HI-Q	20047
Hitachi	20037, 20042, 20055
Howard Computers	21972
HP	21972
Hughes Network Systems	20042, 20739
iBUYPOWER	21972
JVC 20045,	20067
KEC	20037, 20278
Kenwood	20067, 20038
KLH	20072
Kodak	20035, 20037
Kolin	20043

LG	20037, 20045, 20042, 20209
Logik	20072
LXI	20037
Magnavox	20035, 20039, 20081
Magnin	20240
Marantz	20035, 20081
Marta	20037
Matsushita	20035, 20162
Media Center PC	21972
MEI	20035
Memorex	20035, 20162, 20037, 20048, 20039, 20047, 20240, 20104, 20209, 20479
MGA	20240, 20043
MGN Technology	20240
Microsoft	21972
Mind	21972
Minolta	20042
Mitsubishi	20067, 20043
Motorola	20035, 20048
MTC	20240
Multitech	20072
NEC	20035, 20037, 20048, 20104, 20067, 20038
Newave	20037
Nikko	20037
Noblex	20240
Northgate	21972
Olympus	20035
Optimus	21062, 20162, 20037, 20048, 20104, 20432
Orion	20184, 20209, 20002, 20479
Panasonic	21062, 20035, 20162, 20616, 20225
Penney	20035, 20037, 20240, 20042, 20038
Pentax	20042
Philco	20035, 20479
Philips	20035, 20081, 20739, 20618
Pilot	20037
Pioneer	20042, 20067
Polk Audio	20081
Profitronic	20240
Proscan	20060
Protec	20072
Pulsar	20039
Qisheng	20060
Quasar	20035, 20162
Radix	20037
Randex	20037
RCA	20060, 20035, 20240, 20042, 20880
Realistic	20035, 20037, 20048, 20047, 20104
ReplayTV	20616
Runco	20039
Sampo	20037, 20048
Samsung	20240, 20045, 20432
Sanky	20048, 20039
Sansui	20067, 20209, 20479
Sanyo	20047, 20240, 20104
Scott	20184, 20045, 20121, 20043
Sears	20035, 20037, 20047, 20042, 20104
Sharp	20048, 20209
Shintom	20072
Shogun	20240
Singer	20072
Sonic Blue	20616
Sony	20035, 20032, 20033, 20636, 21972
STS	20042
Sylvania	20035, 20081, 20043

Device program codes

Device codes for VCRs

(continued from previous page)

Systemax	21972
Tagar Systems	21972
Tashiko	20037
Tatung	20045, 20067
Technics	20035, 20162
Teco	20035, 20037, 20048, 20038
Teknika	20035, 20037
Tivo	20636, 20618, 21503, 20739
TMK	20240
Toshiba	20045, 20042, 20067, 20043, 21503, 21008, 21972
Totevision	20037, 20240
Touch	21972
Unitech	20240
Vector	20045
Vector Research	20038
Victor	20067
Video Concepts	20045
Videomagic	20037
Videosonic	20240
Viewsonic	1972
Wards	20060, 20035, 20048, 20047, 20081, 20240, 20042, 20072
White Westinghouse	20209, 20072
XR-1000	20035, 20072
Yamaha	20038
Zenith	20039, 20033, 20209, 20479
ZT Group	21972

Device codes for DVD players

Aiwa	20641, 21912, 20770
Allegro	20869
Apex Digital	20672, 20717, 20797, 21061, 20796, 21056, 21937, 20794, 21020, 21915
Blaupunkt	20717
Blue Parade	20571, 20695
Changhong	20627, 21061
CineVision	20869
Coby	21086
Curtis Mathes	21087
CyberHome	21024, 21023, 21129, 20816, 21117
Daewoo	20833, 21172, 20869
Denon	20490
DVD2000	20521
Emerson	20591, 20675
Enterprise	20591
Fisher	21919
Funai	20675
Gateway	21158, 21073
GE	20522, 20717
Go Video	20744, 20833, 21099, 20783, 21075, 20869, 21730
Greenhill	20717
Harman/Kardon	20582, 20702
Hitachi	20573, 20664, 21919
Hiteker	20672
Initial	20717
Integra	20627, 21924
JBL	20702
JVC	20558, 20623, 20867
Kenwood	20490, 20534
KLH	20717, 21020, 21149
Koss	20651, 21980

Lasonic	20798
LG	20591, 20869, 20801
Liquid Video	21980
Lite-On	21158, 21058
Loewe	20511
Magnavox	20503, 20539, 21976, 21914, 20675
Marantz	20539
Memorex	20695
Microsoft	20522
Mintek	20717
Mitsubishi	21521, 20521
Nesa	20717
Norcent	21003
Onkyo	20503, 20627, 21924, 20792
Oritron	20651, 21980
Panasonic	20490, 21762, 21990
Philips	20503, 20539, 20646, 21914
Pioneer	20525, 20571
Polaroid	21086, 21061
Polk Audio	20539
Portland	20770
Proscan	20522
Qwestar	20651
RCA	20522, 20571, 20717, 20822
Rio	20869
Rotel	20623
Sampo	20752, 20698, 20490, 20573, 21932, 21075, 20820
Sansui	20695
Sanyo	20695
Sharp	20630, 20752
Sharper Image	21117
Sherwood	20770
Shinco	20717
Shinonic	20533
Sonic Blue	20869, 21099
Sony	20533, 20864, 21033, 21904, 21903
SVA	20717
Sylvania	20675
Symphonic	20675
Teac	20717, 21984, 20809
Technics	20490
Theta Digital	20571
Toshiba	20503, 20695
Urban Concepts	20503
Xbox	20522
Yamaha	20490, 20539, 20545
Zenith	20503, 20591, 20869

Device codes for cable converters

ABC	00003, 00008, 00014, 00899
Bell & Howell	00014
Bell South	00899
Clearmaster	00883
ClearMax	00883
Coolmax	00883
Daeryung	01877, 00877, 00477, 00008
Digi	00637
Director	00476
Dumont	00637
Gehua	00476
General Instrument	00476, 00810, 00276, 00003, 00014
GoldStar	00144
Hamlin	00009, 00273
Hitachi	00014

Jerrold	00476, 00810, 00276, 00003, 00012, 00014
KNC	00008
LG	00144
Memorex	00000
Motorola	00476, 00810, 00276, 01254, 01376
MultiVision	00012
Pace	01877, 00237
Panasonic	00000
Panther	00637
Paragon	00000
Philips	00317, 01305
Pioneer	01877, 00877, 00144, 00533
Pulsar	00000
Quasar	00000
RadioShack	00883
Regal	00279, 00273
Runco	00000
Samsung	00000, 00144
Scientific Atlanta	01877, 00877, 00477, 00008
Sony	01006
Starcom	00003, 00014
Supercable	00276
Supermax	00883
Tocom	00012
Torx	00003
Toshiba	00000
Trans PX	00276
Tristar	00883
TS	00003
V2	00883
Viewmaster	00883
Vision	00883
Vortex View	00883
Zenith	00000, 00525, 00899

Device code for Satellite Receivers

AlphaStar	00772
Chaparral	00216
Crossdigital	01109
DirectTV	00392, 00566, 00639, 01142, 00247, 00749, 01749, 00724, 00819, 01856, 01076, 01109, 00099, 01392, 01640, 01442, 01414, 01108
Dish Network System	01005, 00775, 01505
Dishpro	01005, 00775, 01505
Echostar	01005, 00775, 01505
Expressvu	00775
GE	00566
General Instrument	00869
GOI	00775
Goodmans	01246
Hisense	01535
Hitachi	00819, 00222, 01250
HTS	00775
Hughes Network Systems	01142, 00749, 01749, 01442
I-Lo	01535
JVC	00775
LG	01414, 01226
Magnavox	00724, 00722
Memorex	
Mitsubishi	00749
Motorola	00869
NEC	01270
Next Level	00869
Panasonic	00247, 00701

Device program codes

Device code for Satellite Receivers

(continued from previous page)

Paysat	00724
Philips	01142, 00749, 01749, 00724, 01076, 00722, 00099, 01442
Proscan	00392, 00566
Proton	01535
RadioShack	00869
RCA	00392, 00566, 00855, 00143, 01392
Samsung	01276, 01109, 01108
Sanyo	01219
SKY	00856
Sony	00639, 01640
Star Choice	00869
Tivo	01142, 01442
Toshiba	00749, 01749, 00790, 01285
UltimateTV	01640, 01392
Uniden	00724, 00722
US Digital	01535
USDTV	01535
Voom	00869
Zenith	00856, 01856

Device codes for Audio Amplifiers

Bose	30674
GE	30078
JVC	30331
Marantz	30321
Nakamichi	30321
NEC	30264
Optimus	30395
Realistic	30395
Sansui	30321
Shure	30264
Sony	30689
Soundesign	30078
Victor	30331
Wards	30078
Yamaha	30354, 30133

Device codes for CD Players

Aiwa	30157
Burmester	30420
California Audio Labs	30029
Carver	30157, 30179
Denon	30873
DKK	30000
DMX Electronics	30157
Dynamic Bass	30179
Fisher	30179
Garrard	30420
Genexxa	30032
Harman/Kardon	30157, 30173
Hitachi	30032
Integra	30101
JVC	30072
Kenwood	30826, 30626, 30028, 30037, 30036, 30190
Krell	30157
Linn	30157
Magnavox	30157
Marantz	30626, 30029, 30157
MCS	30029
Miro	30000

Mission	30157
MTC	30420
NSM	30157
Onkyo	30868, 30101
Optimus	31063, 30000, 30032, 30037, 30420, 30179, 31075, 30145
Panasonic	30029
Parasound	30420
Philips	30626, 30157
Pioneer	31063, 31062, 30032
Polk Audio	30157
Proton	30157
QED	30157
Quad	30157
Quasar	30029
RadioShack	31075
RCA	31062, 30032, 30420, 30179, 30053
Realistic	30420, 30179
Rotel	30157, 30420
SAE	30157
Sansui	30157
Sanyo	30179
SAST	30157
Sharp	30861, 30037
Silsonic	30888, 30036
Sonic Frontiers	30157
Sony	30490, 30000, 30100
Soundesign	30145
TAG McLaren	30157
Tascam	30420
Teac	30420
Technics	30029
Victor	30072
Wards	30157, 30053
Yamaha	30888, 30036
Zonda	30157

RadioShack	31263
RCA	31023, 31609, 31254, 30531, 31074
Sharper Image	31263
Silsonic	30176
Sony	31058, 31441, 31258, 31759
Soundesign	30670
Stereophonics	31023
Sunfire	31313
Teac	31074, 31267
Technics	31308, 31518, 30039
Thorens	31189
Victor	30074
Wards	30014
Yamaha	30176, 31276, 31176

Device codes for Audio Amps/ Tuners

ADC	30531, 31405, 31243, 30121
Anam	31609, 31074
Audiotronic	31189
Bose	31229
Capetronic	30531
Carver	31189
Coby	31263
Denon	31360, 31142, 30904
Fonmix	31360
Glory Horse	31263
Harman/Kardon	30110
Hitachi	31273
Inkel	30027
Integra	30135
JBL	30110
JVC	30074, 31263
Kenwood	31313, 31570, 30027
KLH	31428
Magnavox	31189, 31269, 30531
Marantz	31189, 31269, 30039
MCS	30039
Onkyo	30842, 30135
Optimus	31023, 30670, 30531, 31074
Panasonic	31518, 30039
Philips	31189, 31269
Pioneer	31023, 30150, 30014, 30630, 30531
Proscan	31254
Qisheng	31609
Quasar	30039

Power ON

Operation status	TV status	"Ready" LED	POWER LED
1. Plug the power cord into a 110V outlet.	TV is off (no picture).	Not lit.	Solid orange.
2. Press the POWER button on the TV side panel.	TV is turning on (no picture).	Flashing orange.	Solid green.
3. Power ON successful.	Picture on screen.	Not lit.	Solid green.

Power OFF

Operation status	TV status	"Ready" LED	POWER LED
1. Press the POWER button on the TV side panel. <i>Note: Allow at least 40 seconds for the lamp to cool down before you press the POWER key a <u>second time</u> to turn off the TV.</i>	Lamp cooling.	Flashing orange.	Solid orange.
2. Power OFF successful.	TV is off (no picture).	Not lit.	Solid orange.

Setting the Quick Restart™ feature

When the Quick Restart™ feature set to YES, the TV will stay in Low Power Shutdown mode for several minutes after the TV is turned off.

When the Quick Restart™ feature set to YES and the TV is turned on from Low Power Shutdown mode, the picture appears immediately. (See "Important notice about hot lamp restart," at right.)

To set the Quick Restart™ feature:

1. Press MENU, and then press ▲ or ▼ until the SETUP menu appears.
2. Press ► and then press ▲ or ▼ to highlight Quick Restart™.
3. Press ► to select either YES or NO and press ENTER.

Note:

If Quick Restart™ is set to NO and you turn off the TV, it can take a few minutes for the picture to appear when you turn on the TV again.

If Quick Restart™ is set to YES and you turn off the TV, the following will occur for a few minutes:

- The screen (lamp) lights dimly.
- The fans continue to run.

This is a function of the Quick Restart™ Low Power Shutdown mode and is not a TV malfunction. If you do not prefer this, set the Quick Restart™ feature to NO.

When the Quick Restart™ feature is set to NO, if you repeatedly turn the TV on and off in a short period of time, the useful service life of the lamp may be shorter than the average useful service life.

IMPORTANT NOTICE ABOUT HOT LAMP RESTART

When the TV has been powered on long enough for the lamp unit to get hot, it may take several minutes for the picture to appear in the following situations:

- When the Quick Restart feature is set to NO and you turn the TV off and then on again within a few minutes; or
- If the TV is on when a short-term power failure, power surge, or other similar power failure occurs, such that the TV loses and regains power within a few minutes.

This is a property of DLP TV lamp technology and is NOT a sign of malfunction.

If this occurs, the power and the lamp LEDs on the TV will blink until the TV is finished restarting the lamp and the normal picture appears.

Navigating the menus

1. Press MENU to open the menu system.
2. Press ▼ to select a menu, and then press ► to enter the menu.
3. Press ▼ to select a sub-menu, and then press ► to enter the sub-menu.
4.
 - a. To adjust a sub-menu with a slider bar, press ►. When done, press ENTER and then press EXIT.
 - b. To adjust the other sub-menus, press ▲▼. When done, press EXIT.

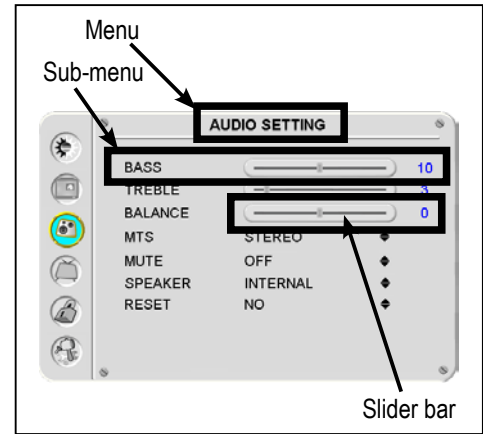

Programming channels into the TV's channel memory

1. Press the TV/DTV button on the remote control to select the source (TV).
2. Press MENU to open the menu system.
3. Select the TV/DTV SETTING menu (see "Navigating the menus," above).
4. Select the TV SYSTEM sub-menu.
5. Press ▲▼ to select ANTENNA, CABLE STD, CABLE HRC, or CABLE IRC and then press ENTER.



6. Press ▼ and then ► to select the AUTO SCAN sub-menu.
7. Press ▲▼ to select YES, and then press ENTER. The automatic channel scan starts.

Note: To manually stop the automatic channel scan, press EXIT.



Using the IMAGE SETTING menu

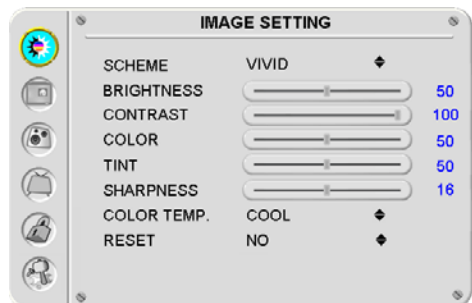

After selecting a setting, press ENTER.
See "Navigating the menus" on page 20.

SCHEME

Select USER, VIVID, DIMMER, GAME, or SPORT video mode.

BRIGHTNESS

- ◀ = reduces image brightness.
- ▶ = increases image brightness.

CONTRAST

- ◀ = reduces image contrast.
- ▶ = increases image contrast.

COLOR

- ◀ = reduces image color saturation.
- ▶ = increases image color saturation.

TINT

- ◀ = increases red tone in the image.
- ▶ = increases green tone in the image.

SHARPNESS

- ◀ = reduces image sharpness.
- ▶ = increases image sharpness.

COLOR TEMPERATURE

Select COOL, MEDIUM, or WARM image color temperature.

RESET

- Select YES to reset all of your image settings to the factory default settings.
- Select NO to retain your current image settings.

Using the AUDIO SETTING menu



After selecting a setting, press ENTER.
See "Navigating the menus" on page 20.

BASS

- ◀ = reduces bass; ▶ = increases bass.

TREBLE

- ◀ = reduces treble; ▶ = increases treble.

BALANCE

- ◀ = increases sound from the left speaker.
- ▶ = increases sound from the right speaker.

MTS*

NTSC SYSTEM:

Select STEREO, MONO, or SAP TV audio.

ATSC SYSTEM:

Select ENGLISH, FRENCH, or SPANISH for the on-screen menus and messages.

**You can also repeatedly press MTS on the remote control to adjust this feature.*

MUTE**

Turns the sound ON and OFF.

***You can also press MUTE on the remote control to adjust this feature.*

SPEAKER

Select INTERNAL or EXTERNAL.

RESET

- Select YES to reset all of your audio settings to the factory default settings.
- Select NO to retain your current audio settings.

Using the DISPLAY SETTING menu

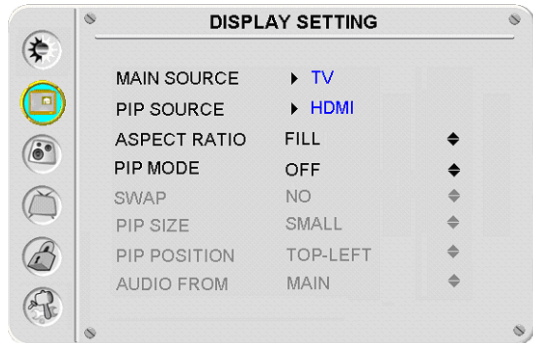

MAIN SOURCE

Select the input signal source for the main picture (TV, AV1, AV2, S-VIDEO, COLOR STREAM HD-1, COLOR STREAM HD-2, DTV, or HDMI). When the sub-picture is open, only one picture (either main or sub) can display an HDMI signal. After selecting a setting, press ENTER. See "Navigating the menus" on page 20

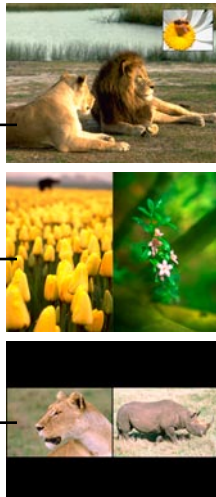

Change the main picture's input signal source.

PIP SOURCE

Select the input signal source for the sub-picture.

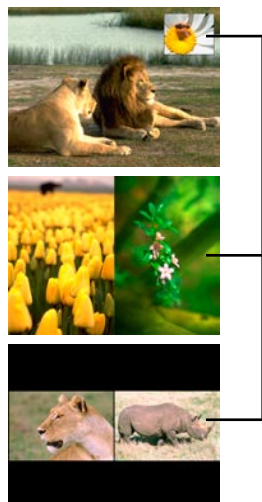

Change the sub-picture's input signal source.

ASPECT RATIO

Note:

- You can also press PIC SIZE on the remote control to change the ASPECT RATIO.
- The way the image displays in any of the aspect ratio settings will vary depending on the format of the program you are currently watching..

- STANDARD**

Suitable for viewing conventional 4:3 programs in their normal format.

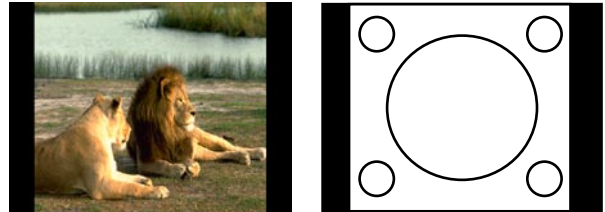

- ZOOM**

Suitable for viewing wide-screen 2.35:1 non-graphic DVDs in full screen.

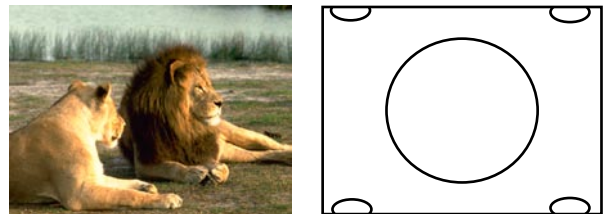

- FILL**

Suitable for stretching 4:3 programs to fill the screen

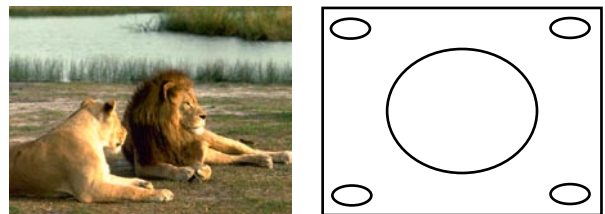

PIP MODE

- OFF**

Displays the main picture only.



- PIP**

Displays the sub-picture on the main picture.

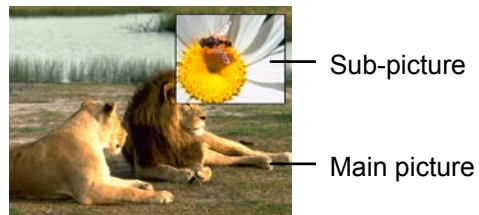

• **PBP**

Divides the screen into half main picture and half sub-picture.



Main picture Sub-picture

• **POP**

Puts the screen in 16:9 aspect ratio and divides the screen into half main picture and half sub-picture.



Main picture Sub-picture

SWAP

Swaps the main picture and sub-picture.

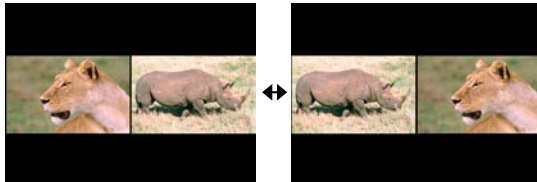

Original position After swap

PIP SIZE

Press ▲▼ to change the sub-picture size (SMALL, MEDIUM, or LARGE).

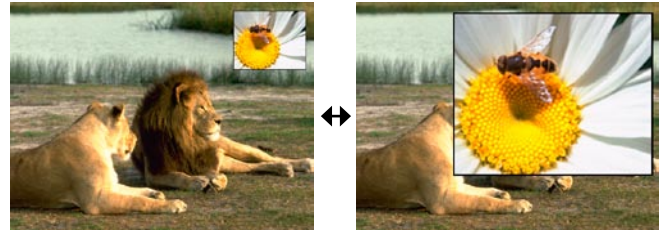

Small PIP size

Large PIP size

PIP POSITION

Press ▲▼ to adjust the horizontal position of the sub-picture.

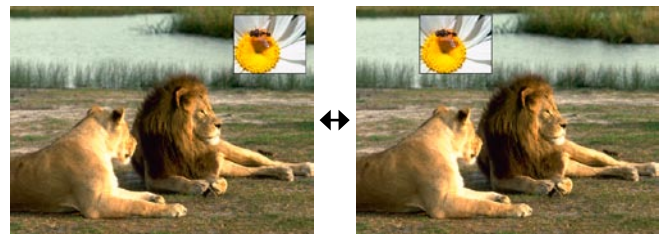

AUDIO FROM :

Choose to hear audio from the Main picture source or the sub-picture source.

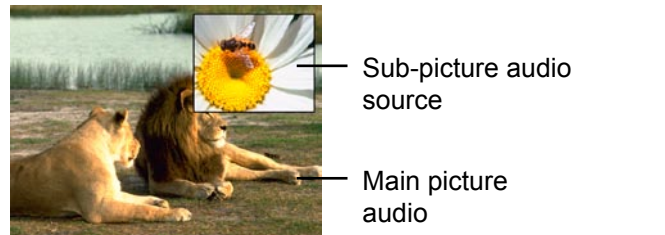

PIP/POP source define

Main \ SUB	TV	S-Video	AV1	AV2	Color Steam HD-1	Color Steam HD-2	HDMI
TV	X	X	X	X	X	X	0
S-Video	X	X	X	X	X	X	0
AV1	X	X	X	X	X	X	0
AV2	X	X	X	X	X	X	0
Color Stream HD-1	X	X	X	X	X	X	0
Color Stream HD-2	X	X	X	X	X	X	0
HDMI	0	0	0	0	0	0	X

X = not available

0 = available

Using the TV/DTV SETTING menu

See "Navigating the menus" on page 20.

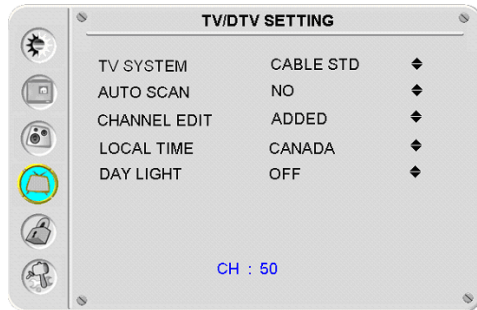

TV SYSTEM

Select your TV system (CABLE STD, CABLE HRC, CABLE IRC, or ANTENNA).

See "Navigating the menus" on page 20.

AUTO SCAN

To automatically scan and store all active channels into the TV's channel memory:

- In the AUTO SCAN sub-menu, select YES and press ENTER.

To retain your current channel memory settings:

- In the AUTO SCAN sub-menu, select NO and press ENTER.

CHANNEL EDIT

Use this feature to manually add and delete channels in the TV's channel memory.

To manually add a channel to the channel memory:

1. Use the Number buttons on the remote control to tune the TV to the channel you want to add.
2. In the CHANNEL EDIT sub-menu, select ADDED, press ENTER, and then press EXIT.

To manually delete a channel from the channel memory:

1. Tune the TV to the channel you want to delete.
2. In the CHANNEL EDIT sub-menu, select SKIPPED, press SEL, and then press EXIT.

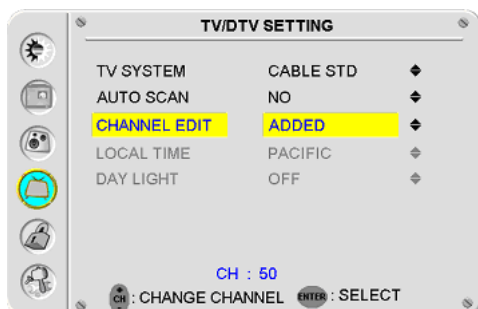

LOCAL TIME (applies to DTV only)

In the LOCAL TIME sub-menu, select your time zone (CANADA, EASTERN, CENTRAL, MOUNTAIN, PACIFIC, ALASKA, HAWAII, SAMOA, or NEWFOUNDLAND) and then press EXIT.

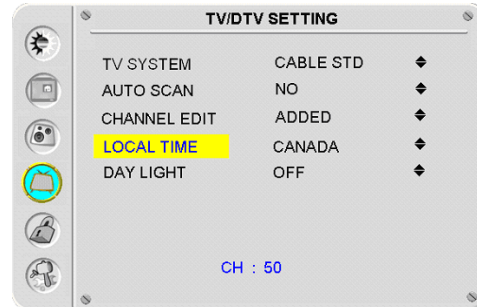

DAY LIGHT (applies to DTV only)

When the DAY LIGHT feature is set to ON, the LOCAL TIME will automatically be adjusted for daylight savings time.

In the DAY LIGHT sub-menu, select ON or OFF, and then press EXIT.

Using the PARENTAL CONTROL menu

See "Navigating the menus" on page 20.



The PARENTAL CONTROL feature allows you to block programs based on their TV or MPAA rating.

The factory default password is 1111.

TV PG RATING

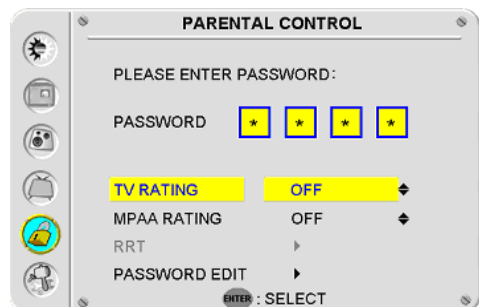

Use ▲▼ to select the rating level you want to block (or unblock), then press ENTER.

- OFF → No TV rating control.
- TV-Y → All Children (This program is designed to be appropriate for all children.)
- TV-Y7 → Directed to Older Children (This program is designed for children age 7 and above.)
- TV-G → General Audience (Most parents would find this program suitable for all ages.)
- TV-PG → Parental Guidance Suggested (This program contains material parents may find unsuitable for younger children.)
- TV-14 → Parents Strongly Cautioned (This program contains some material that many parents would find unsuitable for children under 14 years of age.)
- TV-MA → Mature Audience Only (This program is specifically designed to be viewed by adults and therefore may be unsuitable for children under 17.)

MPAA RATING

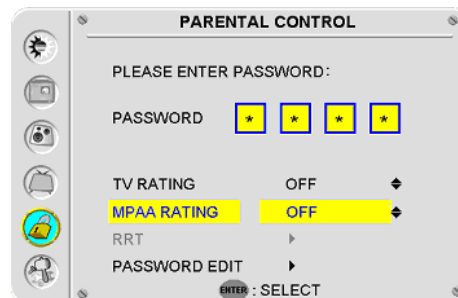

Use ▲▼ to select the rating you want to block or unblock, then press ENTER.

- OFF → No MPAA rating control.
- G → General Audience (Appropriate for all ages.)
- PG → Parental Guidance Suggested (Some material may not be suitable for children.)
- PG-13 → Parents Strongly Cautioned (Some material may be inappropriate for children under 13.)
- R → Restricted (Under 17 requires accompanying parent or adult.)
- NC-17 → Not intended for anyone 17 and under.
- X → X-rated (For adults only.)

PASSWORD EDIT

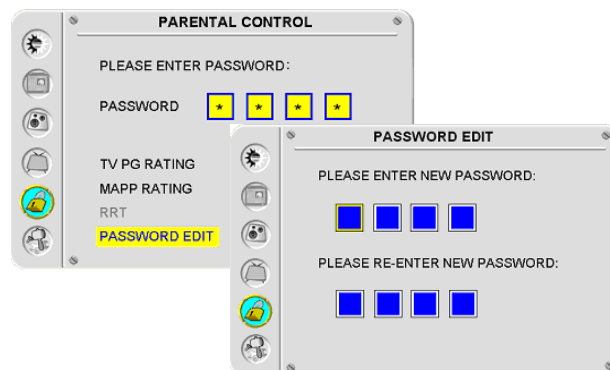

Enter the 4 new digits and the setup automatically proceeds to the next line. Enter the 4 new digits again and press ENTER to confirm that the change is completed.

RRT (Blocking TV programs and movies by additional ratings)

In the future, an additional rating system may become available for use in selectively blocking programs. To download the additional rating system (if available), select RRT and press ENTER.

Note:

- The RRT feature will only be available if an additional rating system is currently available.
- Some period of time may be required to download the additional rating system.
- The information displayed in the RRT screen will depend on the configuration of the additional rating system available at the time of download.
- The additional rating system can only be downloaded one time. You will not be able to download any updates to the rating system unless such updates become available.
- The additional rating system is not designed, transmitted, or controlled by the TV or Toshiba, nor is the availability of an additional rating system determined or controlled by Toshiba. Similarly, the rating of programs in an additional rating system is not determined, transmitted, or controlled by the TV or Toshiba.
- The additional rating system is an evolving technology; therefore, availability, content, and format may vary.

Using the GENERAL SETTING menu

See "Navigating the menus" on page 20.

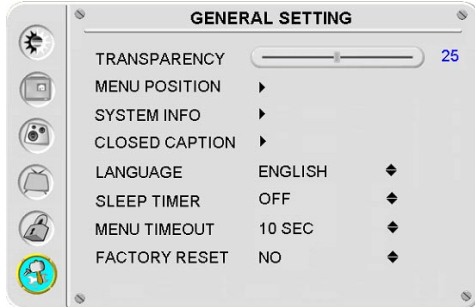

TRANSPARENCY

- Press ◀▶ to change the OSD menu transparency, and then press EXIT.

MENU POSITION

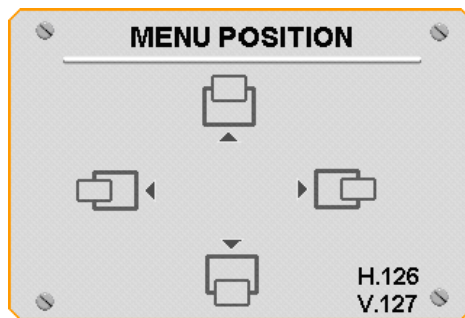

- Press ◀▶ to change the OSD menu H position.
- Press ▲▼ to change the OSD menu V position.

SYSTEM INFO

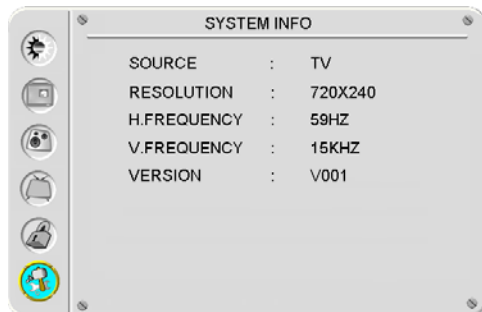

The SYSTEM INFO menu displays the following information:

- SOURCE: The input signal of current main picture.
- RESOLUTION: The main picture signal resolution.
- H. FREQUENCY: The main picture signal horizontal frequency.
- V. FREQUENCY: The main picture signal vertical frequency.
- VERSION: The TV's software version.

CLOSED CAPTION

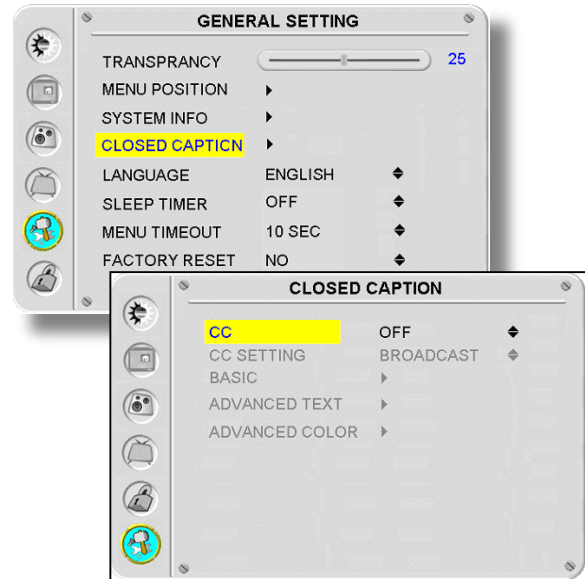

NTSC SYSTEM (TV)

- CC
Press ▲▼ to select closed caption OFF, CC1, CC2, CC3, CC4, TEXT1, TEXT2, TEXT3, or TEXT4, and then press ENTER.

ATSC SYSTEM (DTV)

- CC
Press ▲▼ to select closed caption OFF, CC1, CC2, CC3, CC4, CS1, CS2, CS3, CS4, CS5, CS6, and then press ENTER.
- CC SETTING
Press ▲▼ to select CC SETTING "BROADCAST" or "USER," and then press ENTER.

BASIC

The BASIC sub-menu is enabled when "CC" is set to "CC1~CS6" and "CC SETTING" is set to "USER."

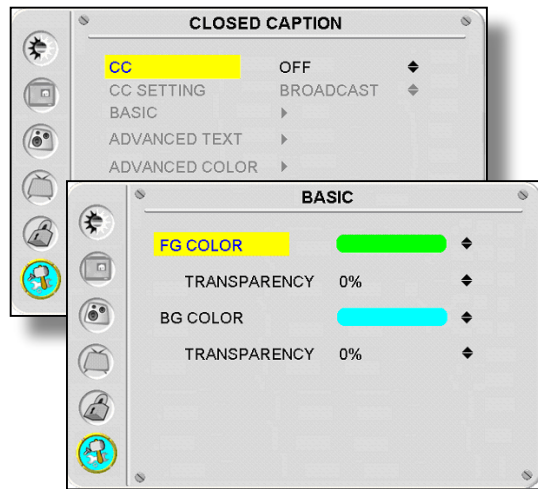

- FG (foreground) COLOR:
→ Change foreground color.
- TRANSPARENCY :
→ Change foreground transparency.
- BG (background) COLOR:
→ Change background color.
- TRANSPARENCY :
→ Change background transparency.

ADVANCED TEXT

The ADVANCED TEXT sub-menu is enabled when "CC" is set to "CC1~CS6" and "CC SETTING" is set to "USER."

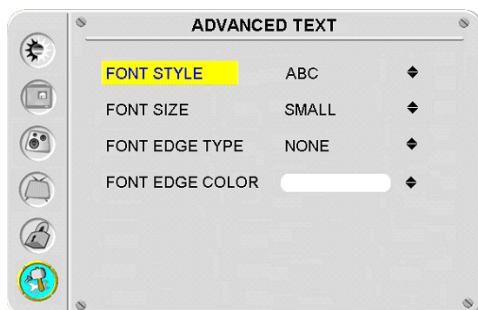

- FONT STYLE:
→ Change font to different style.
- FONT SIZE:
→ Change font size (SMALL, MEDIUM, LARGE).
- FONT EDGE TYPE:
→ Change font edge style (NONE, LEFT, RIGHT, UNIFORM, RAISE, LOWER).
- FONT EDGE COLOR:
→ Change font edge color.

ADVANCED COLOR

The ADVANCED COLOR sub-menu is enabled when "CC" is set to "CC1~CS6" and "CC SETTING" is set to "USER."

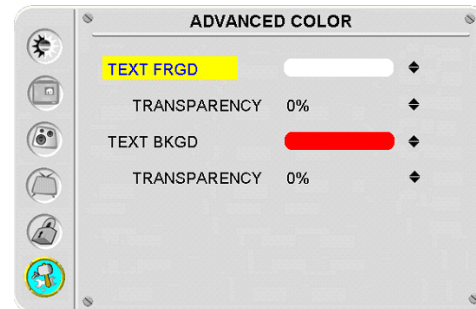

- TEXT FRGD (foreground):
→ Change text foreground color.
- TRANSPARENCY :
→ Change text foreground transparency.
- TEXT BKGD (background):
→ Change text background color.
- TRANSPARENCY :
→ Change text background transparency.

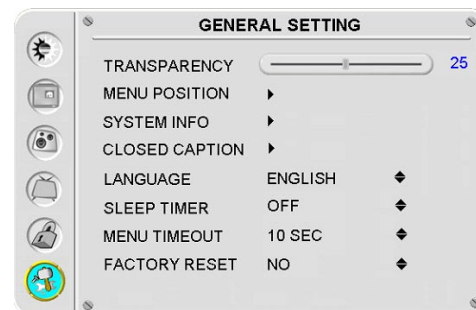

LANGUAGE

You can display the on-screen display menus and messages in ENGLISH, FRENCH, or SPANISH.

SLEEP TIMER*

You can set the sleep timer to turn off the TV after a set length of time (30 MIN, 60 MIN, or 120 MIN).

You can also press SLEEP on the remote control to set the sleep timer.

MENU TIMEOUT

You can set the menu timeout to automatically close an OSD menu after a set length of time (10 SEC, 30 SEC, 60 SEC).

FACTORY RESET

- Select YES and press ENTER to reset all of your menu settings to the factory default settings.

Note: If you select YES, you will need perform all initial setup steps again

- Select NO to retain your current menu settings.

DTV information

1. Program Info

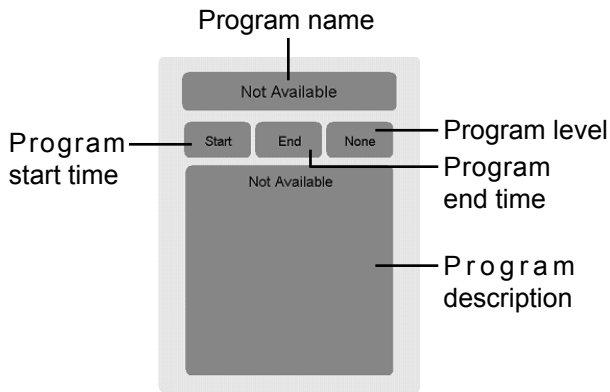
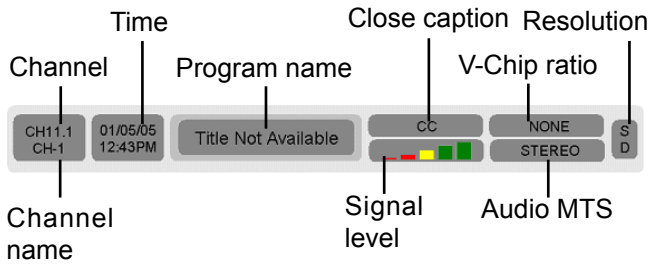

1-1 Press the remote control "INFO" key to display this block.

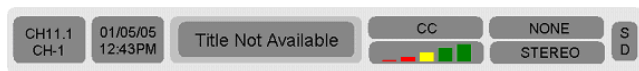

1-2 If press "INFO" key again this block will display.



2. Guide (EPG)

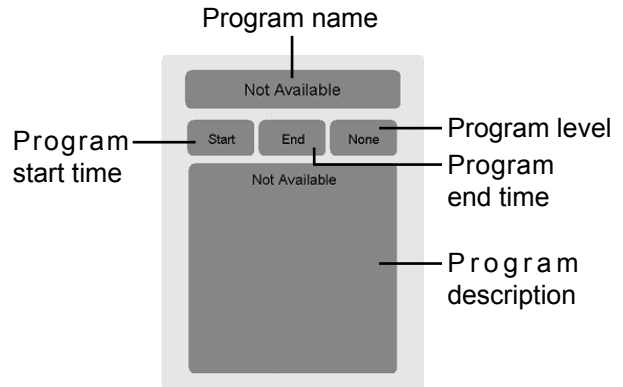
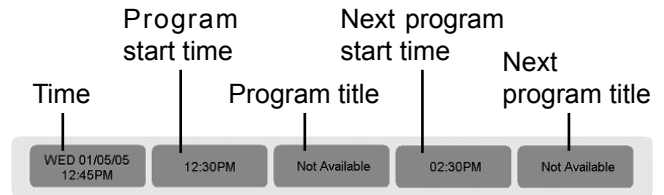

2-1 Press the remote control "INFO" key to display this block.



2-2 Press "INFO" key again to display this block.

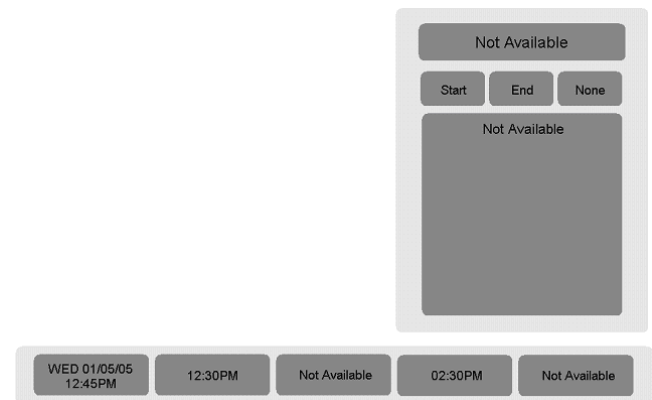

Specifications

- This model complies with the specifications listed below.
- Designs and specifications are subject to change without notice
- This model may not be compatible with features and/or specifications that may be added in the future.











Screen size / Aspect	42 inches diagonally measured / 16:9	
HDTV Compatibility (Component, HDMI)	480i, 480P, 720P, 1080i	
Video Compatibility (CVBS, S-Video)	NTSC-M	
Tuner Compatibility	NTSC-M / ATSC / Clear QAM	
Audio Features	Build in Audio Amplifier and Speakers, 10W x 2 channels Volume/Bass/Treble/Balance Controls Mute Multi-channel television sound MTS (USA)	
Input/Output Terminals	Side	Input1: 1 CVBS, 1 R/L
	Rear	Input1: 1 CVBS, 1 S -Video, 1 R/L Input2: 1 Component Video (Y/Pb/Pr, Y/Cb/Cr HDTV ready), 1 RL Input3: 1 Component Video (Y/Pb/Pr, Y/Cb/Cr HDTV ready), 1 RL Input4: 1 HDMI, 1 R/L RF1: 1 Tuner for NTSC / ATSC / Clear QAM Output1: 1 Coaxial digital Audio SPDIF output (Only for ATSC / Clear QAM & HDMI) Output2: 1 R/L audio output (firmware update via RS232 and USB port)
Remote Control Unit	Infrared remote controller	
OSD Languages	English, French, Spanish	
AC Power Input Range	100~132VAC	
Power Consumption	Normal operating < 280W Power off < 1 W at 110VAC	
Agency Approvals	UL, CUL, FCC, CCC, BSMI	
Dimensions	W: 39.2 in (996 mm) H: 28.4 in (721.5 mm) D: 12.6 in (319.5 mm)	
Packing	Weight:	
	Net:	56.2 lbs (25.5 Kg)
	Gross:	69.4 lbs (31.5 Kg)

Video Input Format

Input Format	Aspect Ratio	Pixel Clock(MHz)	Horizontal Frequency(kHz)	Vertical Frequency(Hz)
480i 4:3	700x480	13.5MHz	15.734/1.001	30.0/1.001
480p 4:3 / SMPTE 293M	700x480	27.000	31.469/1.001	60/1.001
720p / SMPTE 296M	1280x720	74.25/1.001	45.0/1.001	60.0/1.001
1080i / SMPTE 274M	1290x1080i	74.25/1.001	33.750/1.001	30.0/1.001

Troubleshooting

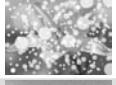
Before calling a service technician, please check this section for a possible cause of the problem and some solutions you can try.

Symptom	Possible solution
Power LED does not light  	<ul style="list-style-type: none"> * Make sure the power cord is not disconnected or loose. * Make sure the fuse and electricity outlet are working properly.
No image 	<ul style="list-style-type: none"> * Make sure the antenna is in place and is not loose . * Make sure the power is on. * Check the image input signal source connection (see pages 8~10). * Check the TV/DTV setting (see page 25). * Make sure the TV station or cable TV system is in service. * Check the video cable connection. * Make sure the frequency range of the input signal is not beyond the display's acceptable range.
The remote control does not work 	<ul style="list-style-type: none"> * The batteries may be dead or may be inserted incorrectly. Replace the batteries. * Make sure the remote control is within 15 feet of the infrared remote sensors on the TV front. * Make sure there is nothing blocking the infrared remote sensors on the remote or the TV.
Delays for video and audio outputs 	<ul style="list-style-type: none"> * If the monitor is warming up, the POWER LED on the front of the TV will be flashing green. * To help protect the lamp, wait at least 60 second after turning off the TV before turning it back on again.
Dim image 	<ul style="list-style-type: none"> * Check the color and color tone settings. * If the picture darkens and/or colors fade, if the screen (lamp) does not light, or if you hear a loud noise and the picture goes black, the lamp may have ruptured. Replace the lamp.
Blurry image 	<ul style="list-style-type: none"> * If there is condensation inside the TV, turn off the TV and let it sit for a few hours before turning it back on again.
Overlapped image 	<ul style="list-style-type: none"> * Check the position of the antenna. * Try moving the signal cable.
Stripes on the screen 	<ul style="list-style-type: none"> * If there is computer, other TV sets, TV video game system, VCR, radio cassette near your TV, please adjust the antenna position.
Snowflakes on the screen or noise interference 	<ul style="list-style-type: none"> * Antenna reception may be poor. Use a highly directional outdoor antenna (if applicable).
Spots on the screen 	<ul style="list-style-type: none"> * A hair dryer, neon light, or high voltage power line can cause this problem. Move the item or the relocate the TV, if possible.
Clear image but no sound 	<ul style="list-style-type: none"> * Press MUTE on the remote control. * Make sure the audio cable is installed correctly. * Make sure the internal speakers are set to OFF (see page 21).

The remote control LED doesn't blink when a button is pressed.
 Replace the batteries.

The remote control LED blinks when a device mode is pressed, but the device does not respond.
 Make sure that you are less than 15 feet (4.57 meters) from the infrared remote sensors on the device.
 Make sure that nothing is blocking the infrared remote sensors on the remote control or the device.
 Make sure that you have selected the correct device mode.
 Make sure that the remote is programmed for that device.
 See "Programming the TV's universal remote control to operate your other devices" on page 14.

The remote control will not accept the device program code.
 Make sure that you followed all the steps in the programming procedure.
 See "Programming the universal remote control" on page 14.
 Make sure that you tried all the program codes listed for the device manufacturer.
 See "Device program codes" on pages 15~18.

Troubleshooting (continued)

OSD messages

1. AUTO SCAN REQUIRED

Need to search TV channel message.

2. MTS

Display TV audio system message.

3. CLOSED CAPTION

Display CC system message.

LED indications

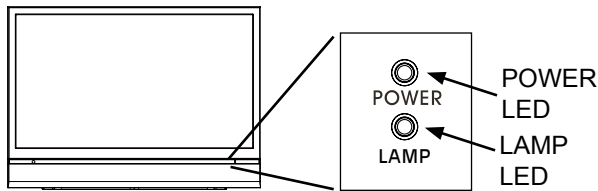

4. NO SIGNAL

Display the main picture no signal input message.

5. SLEEP TIMER

Display sleep timer message.

6. SLEEP TIMER COUNTER

Display sleep timer counter message.

7. NO FUNCTION

If you press the remote control keys for the "Audio", "VGA", "AV mode", "Zoom", "PIP View", "FAV1", "FAV2", this message will be displayed "NO FUNCTION". These functions are not available on this TV.

There are two status LEDs on the front of your Micro Chip Display Projection DLP TV. You can see the table below which displays the LED status and their meanings.

Normal Operation

State	Power LED	Lamp LED	Status Description
AC off	Not lit	Not lit	AC power not connected
DC off when Quick Restart™ feature is set to Yes	Flashing orange	Not lit	1. Low Power Shutdown (LPS) mode. 2. After several minutes, the TV will turn off all power and go to standby mode.
DC off when Quick Restart™ feature is set to No	Orange	Flashing	Lamp cooling several seconds.
Standby mode	Orange	Not lit	AC plug in, DC power off.
Warm-up	Green	Flashing	Lamp ignition.
Operation mode	Green	Not lit	Display is active.
Attempting to light lamp unit	Green blinking	Flashing	If the lamp unit does not light, the TV will try to light it again; this process will repeat up to five times. If it is unsuccessful after the fifth try, an error message will appear on-screen.

Error Codes

State	Power LED	Lamp LED	Status Description
Error1: 2 Green, 1 Orange	LEDG: Flash LEDO: Flash	Hi (OFF)	Any FAN (1 or 2 or 3) failure or disconnected. After the fan detects error 5 sec, the LED shows "ERROR1" message.
Error2: 3 Green, 2 Orange	LEDG: Flash LEDO: Flash	Flash	Lamp ignition failure, Lamp failure, blaster error, Lamp shut off unexpectedly. (The system will shut down main power go to standby mode.)
Error3: 5 Green, 2 Orange	LEDG: Flash LEDO: Flash	Hi (OFF)	DLP hardware error.

Lamp unit replacement and care

How to replace the lamp unit

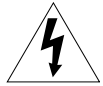

WARNING: RISK OF ELECTRIC SHOCK!



TO REDUCE THE RISK OF ELECTRIC SHOCK, **NEVER REMOVE TV COVERS, EXCEPT AS SPECIFIED HEREIN.** REFER ALL SERVICING NOT SPECIFIED IN THIS MANUAL TO QUALIFIED SERVICE PERSONNEL. Failure to follow this WARNING may result in death or serious injury.

The light source for this TV is a mercury lamp with internal atmospheric pressure that increases during use. The lamp has a limited service life that varies depending on product use and user settings.

As is generally the case with all projection TV's that use projection lamps as a light source, the brightness of the lamp in this TV may vary somewhat over the expected service life and will generally decrease over time. Because of the many variables that can affect the useful service life of the lamp, your experience may vary from other users.

Note : The lamp is warranted only for the periods and to the extent set forth in the Limited Warranty applicable to this set. See " Limited United States Warranty" (on page 34) or "Limited Canada Warranty" (on page 35), as applicable.

If you use the lamp beyond its service life:

- you may notice a reduction in the colors and/ or brightness of the picture; and
- the strength of the quartz glass in the lamp will be reduced and the lamp may repute (often making a loud noise when this happens). If the lamp reatures, the TV will not operated until the lamp unit is replaced.



CAUTION: Always handle the lamp unit with care. The lamp unit in this TV was designed for safe replacement by consumers; however, if the lamp unit is subjected to intentional abuse (such as excessive mechanical abuse or handling by children or pet) the unit may break, exposing sharp edges or pinch points.

Required tools: Manual Slotted screwdriver.

1. Turn off the TV and unplug the power cord.



WARNING: Eye damage may result from directly viewing the light produced by this lamp. Always turn off the TV and unplug the power cord before opening the lamp unit door.

2. **STOP!** Allow the lamp to cool for at least one (1) hour before replacing it.



CAUTION: HOT SURFACE!

Touching the lamp before it has cooled will result in severe burns. **ALLOW THE LAMP TO COOL**



FOR AT LEAST ONE (1) HOUR BEFORE REPLACING IT.

3. On the lamp unit door on the side of the TV, loosen the screw by using a slotted screwdriver and then remove the lamp unit door.

TV back

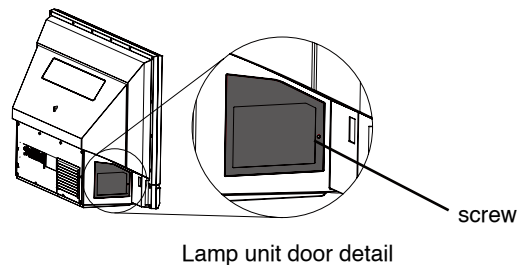

Lamp unit door detail

4. Using a Slotted screwdriver or a coin, loosen the two screws on the lamp unit.

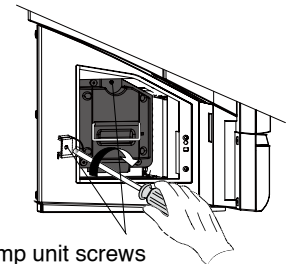

Lamp unit screws



WARNING: RISK OF ELECTRIC SHOCK!



The lamp unit door is provided with an interlock to reduce the risk of electric shock and excessive ultraviolet radiation. **Never defeat its purpose or attempt to service without removing the lamp unit door completely.** Failure to follow this WARNING may result in death or serious injury.

5. Grasp the lamp unit handle and gently pull the lamp unit straight out of the TV. Set the old lamp unit aside (see "Disposing of the used lamp unit" on page 33).

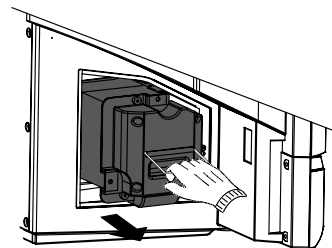

Note: Wear soft, lint-free gloves when replacing the lamp unit.

Lamp unit replacement and care (continued)

How to replace the lamp unit (continued)

6. Carefully insert the new lamp unit straight into the TV until it is fully seated.

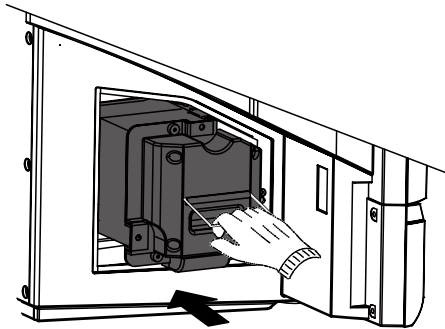

Note :

- Never subject the lamp unit to excessive shock.
- Never touch the lamp unit glass or otherwise get it dirty. Doing so may affect the image quality and reduce the service life of the lamp. See "Cleaning the lamp unit glass" below.

CLEANING THE LAMP UNIT GLASS

If you accidentally touch the lamp unit glass or otherwise get it dirty, wipe it with a lint-free lens cleaning cloth (such as a cloth for cleaning camera lenses or eyeglasses).



CAUTION: NEVER clean a hot lamp with any type of flammable liquid or aerosol cleaning agent. Many ordinary cleaning agents (such as glass cleaners) contain chemicals that may be flammable at certain temperatures. If the lamp unit is not allowed to cool for at least one (1) hour, such chemicals may ignite.

7. Using a Slotted screwdriver, tighten the two lamp unit screws.

Note: Hand-tighten only. Do not use an electric screwdriver.

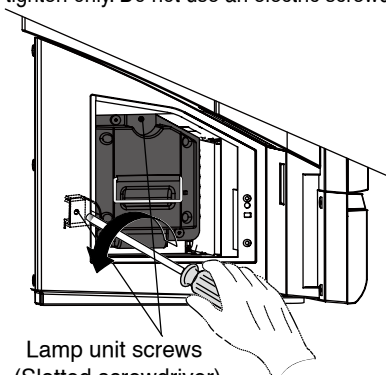

Lamp unit screws
(Slotted screwdriver)



NOTE : Make sure the lamp unit and screws are installed securely; otherwise, the TV may not turn on and the lamp life may be shortened.

8. Reattach the lamp unit door, making sure to insert the hooks on the left side of the lamp unit door inside the opening in the TV cabinet.

Insert the hooks inside the TV cabinet opening.

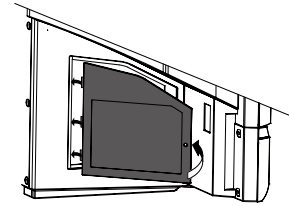

Lamp unit door

9. Replace the screw and tighten using a Slotted screwdriver.

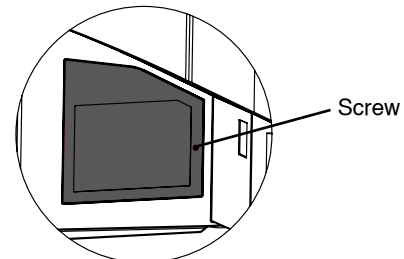

Lamp unit door



NOTE : Make sure the lamp unit door is installed securely, otherwise, the TV may not turn on.

10. Plug in the power cord and turn on the TV. After the initial warmup period (which may take several seconds for full picture brightness), the TV should operate normally. If any of the following conditions exist, turn off the TV, unplug the power cord, and repeat steps 1–9 to ensure that the lamp unit and lamp unit door are installed correctly:

- No picture
- Dark picture
- TV will not turn on

If, after repeating steps 1–9, the problem still exists:
Call Customer Service at 1-800-631-3811.

Disposing of the used lamp unit

- Place the used lamp unit in the empty box from the new unit.
- Keep the lamp unit out of reach of children and pets.



CAUTION: Always handle the lamp unit with care.

The lamp unit in this TV was designed for safe replacement by consumers; however, if the lamp unit is subjected to intentional or accidental abuse (such as excessive mechanical abuse or handling by children or pets), the unit may break, exposing sharp edges or pinch points.

- Dispose of the used lamp unit by the approved method for your area.



NOTE : The lamp unit contains mercury. Disposal of mercury may be regulated due to environmental considerations. For disposal or recycling information, contact your local authorities or the Electronic Industries Alliance (www.eiae.org).

Limited United States Warranty for DLP™ Television Models

Toshiba America Consumer Products, L.L.C. ("TACP") makes the following limited warranties to original consumers in the United States.

THESE LIMITED WARRANTIES EXTEND TO THE ORIGINAL CONSUMER PURCHASER OR ANY PERSON RECEIVING THIS DLP™ TELEVISION AS A GIFT FROM THE ORIGINAL CONSUMER PURCHASER AND TO NO OTHER PURCHASER OR TRANSFEREE.

DLP™ TELEVISIONS PURCHASED IN THE U.S.A. AND USED ANYWHERE OUTSIDE OF THE U.S.A., INCLUDING, WITHOUT LIMITATION, CANADA AND MEXICO, ARE NOT COVERED BY THESE WARRANTIES. DLP™ TELEVISIONS PURCHASED ANYWHERE OUTSIDE OF THE U.S.A., INCLUDING, WITHOUT LIMITATION, CANADA AND MEXICO, AND USED IN THE U.S.A., ARE NOT COVERED BY THESE WARRANTIES.

Limited One (1) Year Warranty on Parts and Labor

TACP warrants this DLP™ Television and its parts against defects in materials or workmanship for a period of one (1) year after the date of original retail purchase. DURING THIS PERIOD, TACP WILL, AT TACP'S OPTION, REPAIR OR REPLACE A DEFECTIVE PART WITH A NEW OR REFURBISHED PART WITHOUT CHARGE TO YOU FOR PARTS OR LABOR. During this period, TACP Authorized Service Station personnel will come to your home when warranty service is required. Depending on the type of repair required, the service will either be performed in your home or the DLP™ Television will be taken to a TACP Authorized Service Station for repair and returned to your home at no cost to you.

Limited One (1) Year Warranty on Lamp Unit

TACP warrants the original lamp unit contained in this DLP™ Television against defects in materials or workmanship for a period of one (1) year after the date of original retail purchase. DURING THIS PERIOD, TACP WILL, AT TACP'S OPTION, EXCHANGE A DEFECTIVE LAMP UNIT WITH A NEW OR REFURBISHED LAMP UNIT WITHOUT CHARGE TO YOU. LABOR CHARGES FOR LAMP UNIT REPLACEMENT ARE YOUR RESPONSIBILITY AND ARE NOT COVERED UNDER THIS WARRANTY. The lamp unit is a user-replaceable component.

Rental Units

The warranty for DLP™ Television rental units begins on the date of the first rental or thirty (30) days after the date of shipment to the rental firm, whichever comes first.

Limited Warranty for Commercial Units

TACP warrants DLP™ Televisions, including the lamp units contained therein, that are sold and used for commercial purposes as follows: all parts are warranted against defects in materials or workmanship for a period of ninety (90) days after the date of original retail purchase.

DURING THIS PERIOD, TACP WILL, AT TACP'S OPTION, REPAIR OR REPLACE A DEFECTIVE PART WITH A NEW OR REFURBISHED PART WITHOUT CHARGE TO YOU.

Owner's Manual and Product Registration

Read this owner's manual thoroughly before operating this DLP™ television.

Complete and mail the enclosed product registration card or register your DLP™ Television online at www.tacp.toshiba.com/service as soon as possible. By registering your DLP™ Television you will enable TACP to bring you new products specifically designed to meet your needs and help us to contact you in the unlikely event a safety notification is required under the Consumer Product Safety Act. Failure to register your product does not diminish your warranty rights.

Your Responsibility

THE ABOVE WARRANTIES ARE SUBJECT TO THE FOLLOWING CONDITIONS:

- (1) You must retain your original bill of sale or provide other proof of purchase.

- (2) All warranty servicing of this DLP™ Television must be performed by an Authorized TACP Service Station.
- (3) The warranties from TACP are effective only if this DLP™ Television is purchased and operated in the Continental U.S.A. or Puerto Rico.
- (4) Labor service charges for set installation, setup, adjustment of customer controls, and installation or repair of antenna systems are not covered by this warranty. Reception problems caused by inadequate antenna systems, misaligned satellite dishes, cable television distribution, VCRs, DVD players/recorders, personal computer level IEEE1394 devices, and any other connected signal source device are your responsibility.
- (5) Warranties extend only to defects in materials or workmanship as limited above, and do not extend to any DLP™ Television or parts that have been lost or discarded by you or to damage to the DLP™ Television or parts caused by fires, misuse, accident, Acts of God (such as lightning or fluctuations in electric power), improper installation, improper maintenance, or use in violation of instructions furnished by TACP; use or malfunction through simultaneous use of this DLP™ Television and connected equipment; or to units that have been modified or had the serial number removed, altered, defaced, or rendered illegible.

How to Obtain Warranty Service

If, after following all of the operating instructions in this manual and reviewing the section titled "Troubleshooting," you find that service is needed:

- (1) To find the nearest TACP Authorized Service Station, visit TACP's web site at www.tacp.toshiba.com/service or contact TACP's Consumer Solution Center toll free at **1-800-631-3811**.
- (2) You must present your original bill of sale or other proof of purchase to the TACP Authorized Service Station.

**For additional information,
visit TACP's web site: www.tacp.toshiba.com.**

ALL WARRANTIES IMPLIED BY THE LAW OF ANY STATE OF THE U.S.A., INCLUDING THE IMPLIED WARRANTIES OF MERCHANTABILITY AND FITNESS FOR A PARTICULAR PURPOSE, ARE EXPRESSLY LIMITED TO THE DURATION OF THE LIMITED WARRANTIES SET FORTH ABOVE. WITH THE EXCEPTION OF ANY WARRANTIES IMPLIED BY THE LAW OF ANY STATE OF THE U.S.A. AS HEREBY LIMITED, THE FOREGOING WARRANTY IS EXCLUSIVE AND IN LIEU OF ALL OTHER WARRANTIES, GUARANTEES, AGREEMENTS, AND SIMILAR OBLIGATIONS OF TACP WITH RESPECT TO THEREPAIR OR REPLACEMENT OF ANY PARTS. IN NO EVENT SHALL TACP BE LIABLE FOR CONSEQUENTIAL OR INCIDENTAL DAMAGES (INCLUDING, BUT NOT LIMITED TO, LOST PROFITS, BUSINESS INTERRUPTION, OR MODIFICATION OR ERASURE OF RECORDED DATA CAUSED BY USE, MISUSE OR INABILITY TO USE THIS DLP™ TELEVISION).

Noperson, agent, distributor, dealer, or company is authorized to change, modify, or extend the terms of these warranties in any manner whatsoever. The time within which an action must be commenced to enforce any obligation of TACP arising under the warranty or under any statute or law of the United States or any state thereof is hereby limited to ninety (90) days from the date you discover, or should have discovered, the defect. This limitation does not apply to implied warranties arising under the law of any state of the U.S.A.

THIS WARRANTY GIVES YOU SPECIFIC LEGAL RIGHTS AND YOU MAY ALSO HAVE OTHER RIGHTS WHICH MAY VARY FROM STATE TO STATE IN THE U.S.A. SOME STATES OF THE U.S.A. DO NOT ALLOW LIMITATIONS ON THE DURATION OF AN IMPLIED WARRANTY, WHEN AN ACTION MAY BE BROUGHT, OR THE EXCLUSION OR LIMITATION OF INCIDENTAL OR CONSEQUENTIAL DAMAGES. THEREFORE, THE ABOVEPROVISIONS MAY NOT APPLY TO YOU UNDER SUCH CIRCUMSTANCES.

Limited Canada Warranty for DLP™ Television Models

Toshiba of Canada Limited ("TCL") makes the following limited warranties to original consumers in Canada.

THESE LIMITED WARRANTIES EXTEND TO THE ORIGINAL CONSUMER PURCHASER OR ANY PERSON RECEIVING THIS DLP™ TELEVISION AS A GIFT FROM THE ORIGINAL CONSUMER PURCHASER AND TO NO OTHER PURCHASER OR TRANSFEREE. PRODUCTS PURCHASED IN THE U.S.A. AND USED IN CANADA ARE NOT COVERED BY THESE WARRANTIES. PRODUCTS PURCHASED IN CANADA AND USED IN THE U.S.A. ARE NOT COVERED BY THESE WARRANTIES.

Limited One (1) Year Warranty on Parts and Labor*

TCL warrants this DLP™ television television and its parts against defects in materials or workmanship for a period of one (1) year after the date of original retail purchase. DURING THIS PERIOD, TCL WILL, AT TCL'S OPTION, REPAIR OR REPLACE A DEFECTIVE PART WITH A NEW OR REFURBISHED PART WITHOUT CHARGE TO YOU FOR PARTS OR LABOR. TCL Authorized Service Depot personnel will come to your home when warranty service is required. Depending on the type of repair required, either the service will be performed in your home or the set will be taken to the TCL Authorized Service Depot for repair and returned to your home at no cost to you. IN-HOME SERVICE ONLY APPLIES WITHIN 100 KILOMETERS OF AN AUTHORIZED TCL SERVICE DEPOT.

Limited One (1) Year Warranty on Lamp Unit*

TCL warrants the lamp unit in this DLP™ television against defects in materials or workmanship for a period of one (1) year after the date of original retail purchase. DURING THIS PERIOD, TCL WILL, AT TCL'S OPTION, EXCHANGE A DEFECTIVE LAMP UNIT WITH A NEW OR REFURBISHED LAMP UNIT WITHOUT CHARGE TO YOU. LABOR CHARGES FOR LAMP UNIT REPLACEMENT ARE NOT COVERED UNDER WARRANTY. The lamp unit is a user-replaceable component.

Rental Units

The warranty for rental units, including the lamp units contained therein, begins with the date of first rental or thirty (30) days from the date of shipment to the rental firm, whichever comes first.

*Limited Warranty for Commercial Units

TCL warrants DLP™ televisions, including the lamp units contained therein, sold and used for commercial purposes as follows: all parts are warranted against defects in materials or workmanship for a period of ninety (90) days after the date of original purchase. DURING THIS PERIOD, TCL WILL, AT TCL'S OPTION, REPAIR OR REPLACE A DEFECTIVE PART WITH A NEW OR REFURBISHED PART WITHOUT CHARGE TO YOU. ON-SITE SERVICE ONLY APPLIES WITHIN 100 KILOMETERS OF AN AUTHORIZED TCL SERVICE DEPOT.

Owner's Manual and Product Registration

Read this owner's manual thoroughly before operating this DLP™ television.

Register your product online at www.toshiba.ca as soon as possible. By registering your product you will enable TCL bring you new products specifically designed to meet your needs and help us to contact you in the unlikely event a safety notification is required under the Consumer Product Safety Act. Failure to register your product does not diminish your warranty rights.

Your Responsibility

THE ABOVE WARRANTIES ARE SUBJECT TO THE FOLLOWING CONDITIONS:

- (1) You must provide your bill of sale or other proof of purchase.
- (2) All warranty servicing of this DLP™ television must be performed by an Authorized TCL Service Depot.
- (3) These warranties from TCL are effective only if the DLP™ television is purchased in Canada from an authorized TCL dealer and operated in Canada.

- (4) Labor charges for installation, setup, adjustment of customer controls, and installation or repair of antenna systems are not covered by these warranties. Reception problems caused by inadequate antenna systems are your responsibility.
- (5) Warranties extend only to defects in materials or workmanship as limited above, and do not extend to any DLP™ television or parts that have been lost or discarded by you or to damage to the television or parts caused by fires, misuse, accident, Acts of God (such as lightning or fluctuations in electric power), improper installation, improper maintenance, or use in violation of instructions furnished by TCL; use or malfunction through simultaneous use of this product and connected equipment; or to units that have been modified or had the serial number removed, altered, defaced, or rendered illegible.

How to Obtain Warranty Services

If, after following all of the operating instructions in this manual and checking the "Troubleshooting" section, you find that service is needed:

- (1) To find the nearest TCL Authorized Service Depot, visit TCL's web site at www.toshiba.ca.
- (2) Present your bill of sale or other proof of purchase to the Authorized Service Depot.

**For additional information,
visit TCL's web site: www.toshiba.ca**

ALL WARRANTIES IMPLIED BY THE LAW OF ANY PROVINCE OF CANADA, INCLUDING THE IMPLIED WARRANTIES OF MERCHANTABILITY AND FITNESS FOR A PARTICULAR PURPOSE, ARE EXPRESSLY LIMITED TO THE DURATION OF THE LIMITED WARRANTIES SET FORTH ABOVE. WITH THE EXCEPTION OF ANY WARRANTIES IMPLIED BY THE LAW OF ANY PROVINCE OF CANADA AS HEREBY LIMITED, THE FOREGOING WARRANTY IS EXCLUSIVE AND IN LIEU OF ALL OTHER WARRANTIES, GUARANTEES, AGREEMENTS, AND SIMILAR OBLIGATIONS OF TCL WITH RESPECT TO THE REPAIR OR REPLACEMENT OF ANY PARTS. IN NO EVENT SHALL TCL BE LIABLE FOR CONSEQUENTIAL OR INCIDENTAL DAMAGES (INCLUDING, BUT NOT LIMITED TO, LOST PROFITS, BUSINESS INTERRUPTION, OR MODIFICATION OR ERASURE OF RECORDED DATA CAUSED BY USE, MISUSE, OR INABILITY TO USE THIS PRODUCT).

Noperson, agent, distributor, dealer, or company is authorized to change, modify, or extend the terms of these warranties in any manner whatsoever. The time within which action must be commenced to enforce any obligation of TCL arising under this warranty or under any law of Canada or of any province thereof is hereby limited to 90 days from the date you discover, or should have discovered, the defect. This limitation does not apply to implied warranties arising under the law of any province of Canada.

THIS WARRANTY GIVES YOU SPECIFIC LEGAL RIGHTS, AND YOU MAY ALSO HAVE OTHER RIGHTS, WHICH MAY VARY FROM PROVINCE TO PROVINCE IN CANADA. SOME PROVINCES OF CANADA DO NOT ALLOW LIMITATIONS ON THE DURATION OF AN IMPLIED WARRANTY, LIMITATIONS ON THE TIME WITHIN WHICH AN ACTION MAY BE BROUGHT, OR THE EXCLUSION OR LIMITATION OF INCIDENTAL OR CONSEQUENTIAL DAMAGES; THEREFORE, THE ABOVE LIMITATIONS OR EXCLUSIONS MAY NOT APPLY TO YOU UNDER SUCH CIRCUMSTANCES.

TOSHIBA AMERICA CONSUMER PRODUCTS, L.L.C.

CORPORATE HEADQUARTERS: 82 TOTOWA ROAD, WAYNE, NJ 07470, U.S.A.
NATIONAL SERVICE DIVISION: 1420-B TOSHIBA DRIVE, LEBANON, TN 37087, U.S.A.

TOSHIBA OF CANADA LTD.

HEAD OFFICE: 191 McNABB STREET, MARKHAM, ONTARIO, L3R 8H2, CANADA - TEL: (905) 470-5400
SERVICE CENTERS:
TORONTO: 191 McNABB STREET, MARKHAM, ONTARIO, L3R 8H2, CANADA - TEL: (905) 470-5400
MONTREAL: 18050 TRANS CANADA, KIRKLAND, QUEBEC, H9J 4A1, CANADA - TEL: (514) 390-7766
VANCOUVER: 13551 COMMERCE PARKWAY, SUITE 110, RICHMOND, B.C., V6V 2L1, CANADA - TEL: (604) 303-2500

ColorStream is a registered trademark of Toshiba America Consumer Products, L.L.C.
Digital Light Processing, DLP™ and the DLP medallion are trademarks of Texas Instruments.

PRINTED IN CHNIA
(06-03)

TOSHIBA