

# RCA

## High-Definition Television User's Guide

Changing Entertainment. Again.



# Important Information

---

## WARNING

To reduce the risk of fire or electric shock, do not expose this product to rain or moisture.

## CAUTION

RISK OF ELECTRIC SHOCK  
DO NOT OPEN

**Caution:** To reduce the risk of electric shock, do not remove cover (or back). No user serviceable parts inside. Refer servicing to qualified service personnel.



This symbol indicates "dangerous voltage" inside the product that presents a risk of electric shock or personal injury.



This symbol indicates important instructions accompanying the product.

Refer to the identification/rating label located on the back panel of your product for its proper operating voltage.

FCC Regulations state that unauthorized changes or modifications to this equipment may void the user's authority to operate it.

**Caution: Using video games or any external accessory with fixed images for extended periods of time can cause them to be permanently imprinted on the picture tube (or projection TV picture tubes). ALSO, some network/program logos, phone numbers, black borders (sides, top, bottom) etc. may cause similar damage. This damage is not covered by your warranty.**

**Cable TV Installer:** This reminder is provided to call your attention to Article 820-40 of the National Electrical Code (Section 54 of the Canadian Electrical Code, Part 1) which provides guidelines for proper grounding and, in particular, specifies that the cable ground shall be connected to the grounding system of the building as close to the point of cable entry as practical.

## Product Registration

Please fill out the product registration card (packed separately) and return it immediately. For U.S. customers: Your RCA Consumer Electronics product may also be registered at [www.rca.com/productregistration](http://www.rca.com/productregistration). Returning the card allows us to contact you if needed.

## Product Information

Keep your sales receipt to obtain warranty parts and service and for proof of purchase. Attach it here and record the serial and model numbers in case you need them. These numbers are located on the product.

Model No. \_\_\_\_\_

Serial No. \_\_\_\_\_

Purchase Date: \_\_\_\_\_

Dealer/Address/Phone: \_\_\_\_\_

## Key Features Overview

Your TV is equipped with features that will add to your TV viewing experience. The following section highlights some of your TV's most unique features. Go to Chapter 3 for more details on these and additional features.

### Resolution (it's math...that works for you)

The crisp, lifelike picture that people rave about when experiencing true HDTV is due to the resolution this technology provides. The resolution is measured by calculating the number of active lines of pixels. A pixel (which stands for picture element) is a small dot. The picture you see on your TV is composed of these dots.

A regular, analog television only has a resolution of about 200,000 pixels (480 vertical pixels x 440 horizontal pixels = 211,200 pixels). The HDTV format is capable of more than 2 million pixels (1,920 x 1,080 = 2,073,600).

More pixels equal more detail. In summary, HDTV is capable of resolution that is up to 10 times the resolution of the picture on a regular, analog TV!

Feature	Analog (NTSC)	HD Digital (ATSC)
Total Scan Lines	525	1125
Effective Scan Lines	480	1080
Aspect Ratio	4:3	16:9 (Widescreen)
Max Resolution	720 x 480	1920 x 1080
Sound	2-ch Stereo	5.1 ch Surround



16:9 Aspect Ratio

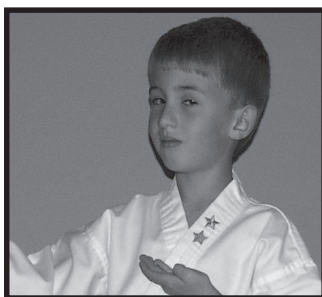

4:3 Aspect Ratio

### Aspect Ratio

Aspect ratio is simply the width and height of the picture. Regular TVs use a 4:3 aspect ratio, which means the picture is a little wider than it is tall (a screen that is 20 inches wide is about 15 inches tall).

When the standards were being developed for television broadcasting in 1941 by the NTSC (the National Television Standards Committee), it made sense to adopt the 4:3 aspect ratio that the film industry was using at that time.

As TVs dropped in price and people prospered in the 1950s, the movie industry had to find a way to get people out of their living rooms and back to the movie theatres. That's when they created the 16:9 aspect ratio (also called widescreen format). When the standards for HDTV were being developed by the ATSC (Advanced Television Standards Committee), the 16:9 aspect ratio was chosen as the format for HDTV.

This widescreen format makes sense because it's much closer to the way we see. Our field of vision is actually much wider than tall because of our peripheral vision. Not only is it closer to the way we see, but the pictures are crisper and cleaner with more detail in the close-up and panoramic views.

# Introduction

---

## Digital Signal and Sound

The analog television broadcast system that has been used in the United States for the past 50 years transmits signals as electronic waves. These waves can suffer degradation as the signal travels to your home. Additionally, the analog waves are susceptible to interference from planes passing overhead, weather, and household appliances.

Digital signals, in contrast to analog signals, can be reproduced precisely because the images are transmitted and received using the computer language of 1s and 0s. Such precision yields a signal that is capable of displaying studio-quality picture and Dolby Digital 5.1 channel sound.

## Integrated HDTV Tuner with Digital Cable Ready QAM

RCA was the first to offer an integrated tuner with its HDTVs (which means there is no need for another box to receive digital programming). Now, we've gone one better— your HDTV's tuner is digital cable ready (no need for a cable box to view unscrambled digital cable programming). The CableCARD™ slot on your HDTV allows you to use a digital cable card to access digital cable. The tuner is able to decode all 16 formats of digital television broadcasts, and it can interpret unscrambled digital cable signals because it includes QAM (Quadrature Amplitude Modulation).

*Note: A digital cable card may be necessary to view scrambled (encrypted) channels. Contact your cable provider for more information. Go to page 15 for more information.*

## TruScan Digital Reality

With the *Film Mode* option turned on, the intelligent signal processing of TruScan Digital Reality recognizes incoming video signals and progressively converts them to achieve optimum digital picture performance. It also recognizes when original film sources have been modified and can automatically convert the analog frame rate back to its original format to bring out the detail—a process commonly referred to as reverse 3:2 pulldown.

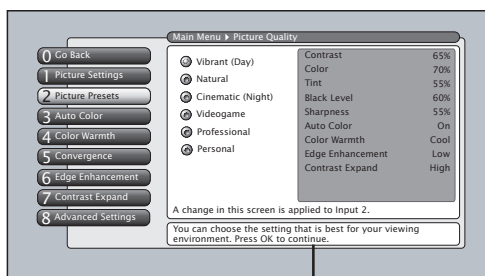

**Help text**

## User-friendly Features Help You Personalize Your TV

- You can customize your TV to fit your viewing taste and match the lighting where you watch TV by using Personal Presets and/or the automatic picture quality settings: Vibrant (Day), Natural, Cinematic (Night), Videogame, Professional. You can adjust each input jack to a different setting and the TV will automatically adjust the picture when you change inputs.
- Help Text: The elaborate, on-screen help text describes your TV's features and explains how to use them.

## Audio/Video Output Jacks

Because the VCRs in most households are analog and can't receive or record digital TV signals, recording digital TV broadcasts wasn't possible without purchasing additional equipment. That's why RCA added AUDIO/VIDEO OUTPUT jacks to this HDTV. These jacks enable you to record both analog and digital programs. RCA understands how you watch TV and what's necessary to make the transition to HDTV seamless.

CableCARD is a registered trademark of Cable Television Laboratories, Inc.

## Introduction

Key Features Overview .....	1
-----------------------------	---

## Chapter 1: Connections & Setup

<b>Things to Consider Before You Connect .....</b>	<b>6</b>
Protect Against Power Surges .....	6
Protect Components from Overheating .....	6
Position Cables Properly to Avoid Audio Interference .....	6
Use Indirect Light .....	6
Using a Stand .....	6
Cables You May Need to Connect Components to Your TV .....	6
<b>Choose Your Connection .....</b>	<b>7</b>
Video Connections .....	7
Digital/Network Connections .....	7
<b>Explanation of Jacks and Cables .....</b>	<b>8</b>
<b>The Front of Your TV .....</b>	<b>11</b>
Front Input Jacks .....	11
Front Panel .....	11
How to Connect: TV + VCR + DVD Player .....	12
How to Connect: TV + Satellite Receiver + VCR .....	13
How to Connect: TV + Component with DVI or HDMI .....	14
How to Connect: TV + CableCARD .....	15
Setting Up Digital Cable Television Service .....	15
<b>Plug in the TV .....</b>	<b>16</b>
<b>Put Batteries in the Remote .....</b>	<b>16</b>
<b>Turn on the TV .....</b>	<b>16</b>
<b>Use the Remote Control to Complete the Assisted Setup .....</b>	<b>16</b>
<b>Complete the Assisted Setup .....</b>	<b>16</b>
Set the Menu Language .....	17
Complete Channel Search .....	17
Changing Channels .....	17
<b>Next Steps .....</b>	<b>17</b>

## Chapter 2: Using the Remote Control

<b>The Buttons on the Remote Control .....</b>	<b>20</b>
<b>Programming the Remote to Operate Other Components .....</b>	<b>21</b>
Find Out If You Need to Program the Remote .....	22
Programming the Remote .....	22
<b>How to Use the Remote After You've Programmed It .....</b>	<b>23</b>
<b>Using the INPUT Button .....</b>	<b>24</b>
<b>Remote Code List .....</b>	<b>24</b>

## Chapter 3: Using the TV's Features

<b>About the Channel Banner .....</b>	<b>28</b>
<b>Digital or Analog TV Channels .....</b>	<b>29</b>
Direct Tuning to a Channel .....	29
<b>Parental Controls .....</b>	<b>30</b>
Lock/Unlock TV .....	30
Channel Lists (Video Input List, Cable Channel List, Antenna Ch. List) .....	30
<b>How V-Chip Works for the USA and Canada .....</b>	<b>31</b>
USA V-Chip TV Ratings .....	31
Canada V-Chip .....	35

# Table of Contents

---

Auto Tuning Feature .....	37
PIP (Picture-in-Picture) Operation .....	38
Emergency Alert System (EAS) .....	39

## Chapter 4: Using the TV's Menu System

<b>Menus, On-screen Help, and Control Panels .....</b>	<b>42</b>
Navigating the Menu System .....	42
On-Screen Help .....	42
Controls .....	42
<b>Picture Quality Menu .....</b>	<b>44</b>
Picture Settings .....	44
Picture Presets .....	44
Auto Color .....	45
Color Warmth .....	45
Convergence .....	45
Edge Enhancement .....	46
Contrast Expand .....	46
Advanced Settings .....	46
<b>Audio Menu .....</b>	<b>47</b>
Equalizer Presets .....	47
Audio Processor .....	47
Sound Logic .....	48
Audio Mode .....	48
SAP (Second Audio Program) .....	48
Balance .....	48
Audio Connections .....	49
Dynamic Bass .....	49
<b>Connections Menu .....</b>	<b>49</b>
Signal Strength .....	50
Channel Search .....	50
Software Upgrade .....	50
Signal Source .....	51
Video Input Setup .....	51
Auto Tuning .....	51
Special Features .....	51
Ethernet Setup .....	52
<b>Preferences Menu .....</b>	<b>52</b>
Closed Captioning .....	53
Screen Format .....	55
Time Menu .....	55
Color Scheme .....	56
Translucency .....	56
Menu Language .....	56

## Chapter 5: Reference

Troubleshooting .....	58
HDTV Specifications .....	61
Accessory Information .....	63
Limited Warranty .....	65
FCC Information .....	67
Care and Cleaning .....	67
Index .....	68

# Connections & Setup

## Chapter Overview:

- Things to Consider Before You Connect
- Choose Your Connection
- Explanation of Jacks and Cables
- The Front of Your TV
- How To Connect
- Plug in the TV
- Put Batteries in the Remote
- Turn on the TV
- Use the Remote Control to Complete the Assisted Setup
- Complete the Assisted Setup
- Next Steps

Changing Entertainment. Again.



## Things to Consider Before You Connect

### Protect Against Power Surges

- Connect all components before you plug any of their power cords into the wall outlet or power strip. NEVER plug your TV into an outlet that is controlled by a wall switch.
- Turn off the TV and/or component(s) before you connect or disconnect any cables.
- Make sure all antennas and cables are properly grounded. Refer to the Important Safeguards sheet packed with your TV.

### Protect Components from Overheating

- Don't block ventilation holes on any of the components. Arrange the components so that air can circulate freely.
- Don't stack components.
- If you place components in a stand, make sure you allow adequate ventilation.
- If you connect an audio receiver or amplifier, place it on the top shelf so the heated air from it won't flow around other components.

### Position Cables Properly to Avoid Audio Interference

- Insert each cable firmly into the designated jack.

### Use Indirect Light

Don't place the TV where sunlight or room lighting will be directed toward the screen. Use soft or indirect lighting.

### Using a Stand

If a stand or base is used, insure that it is of adequate size and strength to prevent the TV from being accidentally tipped over, pushed off, or pulled off. This could cause personal injury and/or damage the TV. Refer to the Important Safety Instructions packed separately.

## Cables You May Need to Connect Components to Your TV

The pictures below show the cables (not supplied) you may need for the connections represented in this book.

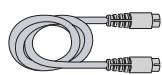

S-Video cable

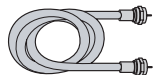

Coaxial cable



A/V Cable

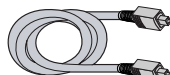

Digital Optical Cable

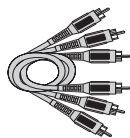

Composite Video  
Audio/ Video cable

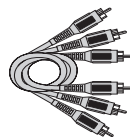

Component Video  
(Y, Pb, Pr) cable

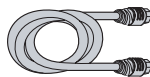

HDMI™ cable (or DVI  
cable and HDMI/DVI  
adapter)











HDMI and High-Definition Multimedia Interface are trademarks or registered trademarks of HDMI Licensing LLC.



## Choose Your Connection

There are several ways to connect your HDTV, depending on the components you want to connect and the quality of the signal you want to achieve. Please use the following chart to determine which connection is best for you. Proceed to the appropriate page and connect your TV. For more information about the relationship between the cables, jacks, and the quality of the signal you see on your TV, go to the following page.

***Note for U.S. Customers:** If you prefer, we can provide you with the name of an Authorized Service Representative who will visit your home for a fee to install your electronic entertainment system and to instruct you in its operation. For details about this service, call 1-888-206-3359. For additional assistance while using your RCA product, please visit [www.rca.com/customersupport](http://www.rca.com/customersupport).*

Components	Cables Needed	Connection Title	Go to...
<b>Video Connections</b>			
 TV  DVD  VCR	Coaxial Audio Component Composite	TV + VCR + DVD Player	page 12
 TV  Satellite Receiver  VCR	Coaxial Audio/video Component Composite	TV + Satellite Receiver + VCR	page 13
<b>Digital/Network Connections</b>			
 TV  Component with DVI or HDMI jack	Coaxial HDMI (or DVI with HDMI/DVI adapter)	TV + Component with DVI or HDMI	page 14
 TV  CableCARD™	Coaxial	TV + CableCARD™	page 15

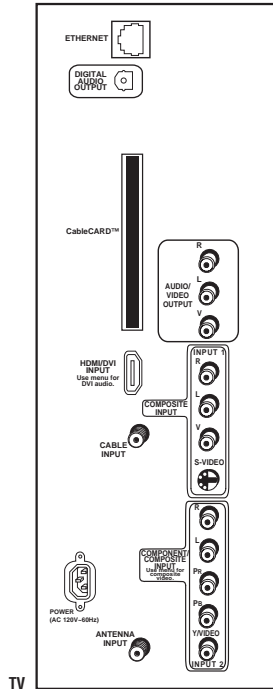

TV

## Explanation of Jacks and Cables

The diagrams below illustrate jacks found on the back of the TV. When connecting cables, be sure to connect corresponding outputs and inputs (video input into video out, right audio input into right audio out, etc.).

This section describes the jacks and cables you might use to make connections (cables may be ordered separately by calling the number on page 63). There are several ways to connect components to your TV.

Different jacks and cables provide a different level of performance. It's important to remember the different degrees of picture quality for comparison. The HDMI/DVI and component jacks are considered excellent; S-Video is very good; composite jacks are good, while connecting components to the Antenna or Cable input is fair.

### AUDIO/VIDEO OUTPUTS and INPUTS

**AUDIO/VIDEO OUTPUT** Connect a VCR or DVD-recorder to record digital and analog programs from the Cable or Antenna Input (excluding copy-protected programs and component video formats) while the TV is turned on. You must leave the TV on the same channel you are recording.

- **R Audio** provides right audio connection and connector is usually red.
- **L Audio** provides left audio connection and connector is usually white.
- **V (Video)** provides composite video connection and connector is usually yellow.

*Notes: When recording from this output, remember to tune to the channel you want to record.*

*If an unusual pattern appears when you connect a VCR to these jacks, playing a tape or switching to the VCR's tuner removes the pattern.*

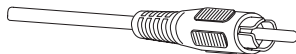
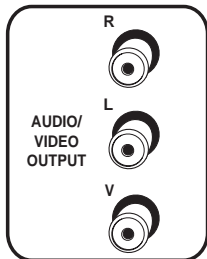

Composite Audio Cable (RCA Type)

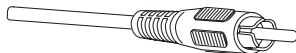

Composite Video Cable (RCA Type)

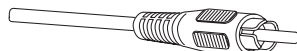
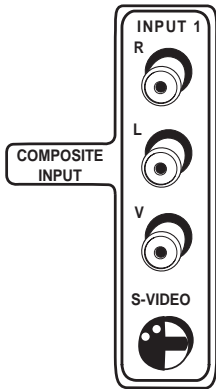

Composite Audio Cable (RCA Type)

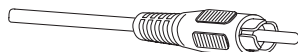

Composite Video Cable (RCA Type)

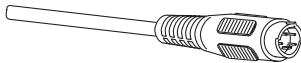

S-Video Cable

**INPUT 1 COMPOSITE INPUT** Connect an NTSC (analog) component. These jacks are used for most audio/video connections between components. The audio/video jacks are often color coded (yellow for video, red for right audio, and white for left audio).

- **R Audio** provides right audio connection and connector is usually red.
- **L Audio** provides left audio connection and connector is usually white.
- **V (Video)** provides composite video connection and connector is usually yellow.
- **S-VIDEO** lets you connect an S-Video cable for better picture quality to a component with S-Video capability, such as a VCR or DVD player. When using S-Video, make sure to connect the two audio cables as well as the S-Video connector.

The S-Video jack provides better picture quality than the composite video jacks because the color (chrominance, also called chroma) part of the signal is separated from the black and white (luminance) part of the picture.

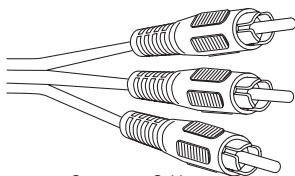
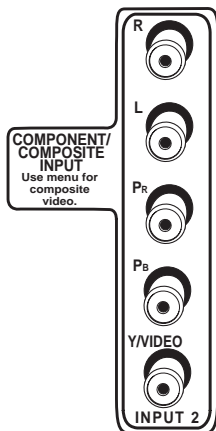

Y (green)

Pr (red)

Pb (blue)

Component Cables

**INPUT 2 COMPONENT/COMPOSITE INPUT** Provides connection to a second NTSC (analog) video component with either composite or component outputs such as a VCR.

- **R Audio** provides right audio connection and connector is usually red.
- **L Audio** provides left audio connection and connector is usually white.
- **Y/Video P<sub>B</sub> P<sub>R</sub>** Unlike a single video input, component (Y, P<sub>B</sub>, P<sub>R</sub>) video maintains the video signal as three separate parts through these three jacks. To ensure maximum picture quality, use three video-grade cables for the Y, P<sub>B</sub>, P<sub>R</sub> connections. Accepts 480i, 480p, 720p, and 1080i signals. If you're connecting to a component with a Video jack instead, you can still use the Y/Video jack. Go to the *Connections* menu, select *Video Input Source* and choose *Composite video* as your source. Go to page 51 for more information.

**Notes:** Also, remember to connect the left and right audio cables because the Y, Pb, Pr cables carry only the picture signal, not the sound. PIP can only be displayed from component inputs in 480i format.

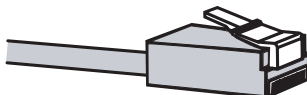

**ETHERNET** Connect a router, cable modem, or Digital Subscriber Line (DSL) modem to the TV using an Ethernet cable (CAT 5) for a possible software upgrade. Go to page 50 for more information on software upgrades. Do not connect a telephone cable because of risk of fire or shock. A green light on the jack means that an active network has been detected. An orange light on the jack means the data is either being sent or received.

# Connections & Setup

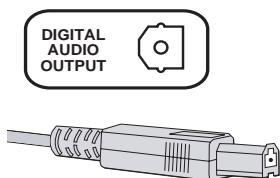

**DIGITAL AUDIO OUTPUT** Use a digital optical cable (or SPDIF cable) to connect your TV to a compatible Dolby Digital\* or PCM receiver or decoder. Dolby Digital offers theatre-quality sound (six audio channels). If you own a receiver that uses an optical cable input, you can use an optical cable to connect the TV to that receiver for the best sound quality. Go to the *Digital Audio Out* screen in the *Audio* menu to select *Auto Select* or *PCM* as the output for this jack.

***Note:** This TV's optical digital output jack fully complies with the international standard governing this type of jack (IEC958), and is designed for connection to a Dolby Digital (AC-3® or PCM) receiver or decoder. Older equipment, some of which is not fully compliant with IEC958, may not be compatible with the Dolby Digital bitstream. Such a connection using anything other than a Dolby Digital (AC-3 or PCM) receiver or decoder could create a high noise level, causing damage to headphones or speakers.*

**CableCARD** Allows you to use a digital cable television card to receive digital cable services, including premium and HDTV cable channels, without the need for a set-top box. Go to page 15 for information on using the CableCARD slot.

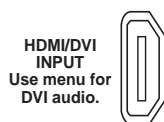
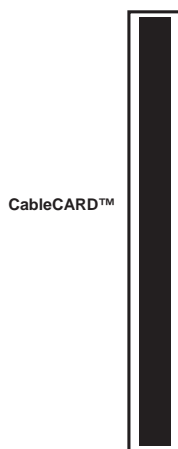

**HDMI/DVI INPUT** (High-Definition Multimedia Interface/Digital Visual Interface) Provides an uncompressed digital interface that carries both video and audio data by way of an integrated mini-plug cable. Since HDMI is based on Digital Visual Interface (DVI) the jack on the back of your TV is also compatible with DVI components.

***Note:** If you connect a component with a DVI jack to the HDMI/DVI input, you'll need an HDMI/DVI adapter. Also, connect the left and right audio cables to an input that is not in use. An example is shown on page 14. Then go to the Audio Connections menu and select DVI Audio Input to choose the input you're using to receive audio.*



**CABLE INPUT** Used to connect a coaxial cable to receive the signal from cable or cable box.

**ANTENNA INPUT** Used to connect a coaxial cable to receive the signal from an off-air antenna.

\*Manufactured under license from Dolby Laboratories. "Dolby" and the double-D symbol are trademarks of Dolby Laboratories.

## The Front of Your TV

### Front Input Jacks

The TV has front input jacks for convenience in connecting a camcorder, digital camera, or video game: an S-VIDEO input, one set of composite AUDIO/VIDEO inputs, and a headphone jack. Look for a hinged door and press to open the cover. Please note the illustration below is just an example of how these jacks might appear.

**Notes:** When you plug in headphones, the TV's internal speakers are muted. Use the VOL up or down button to control the volume.

When connecting a component that uses a monaural cable, such as some camcorders, use the L/MONO input jack to get sound from both speakers.

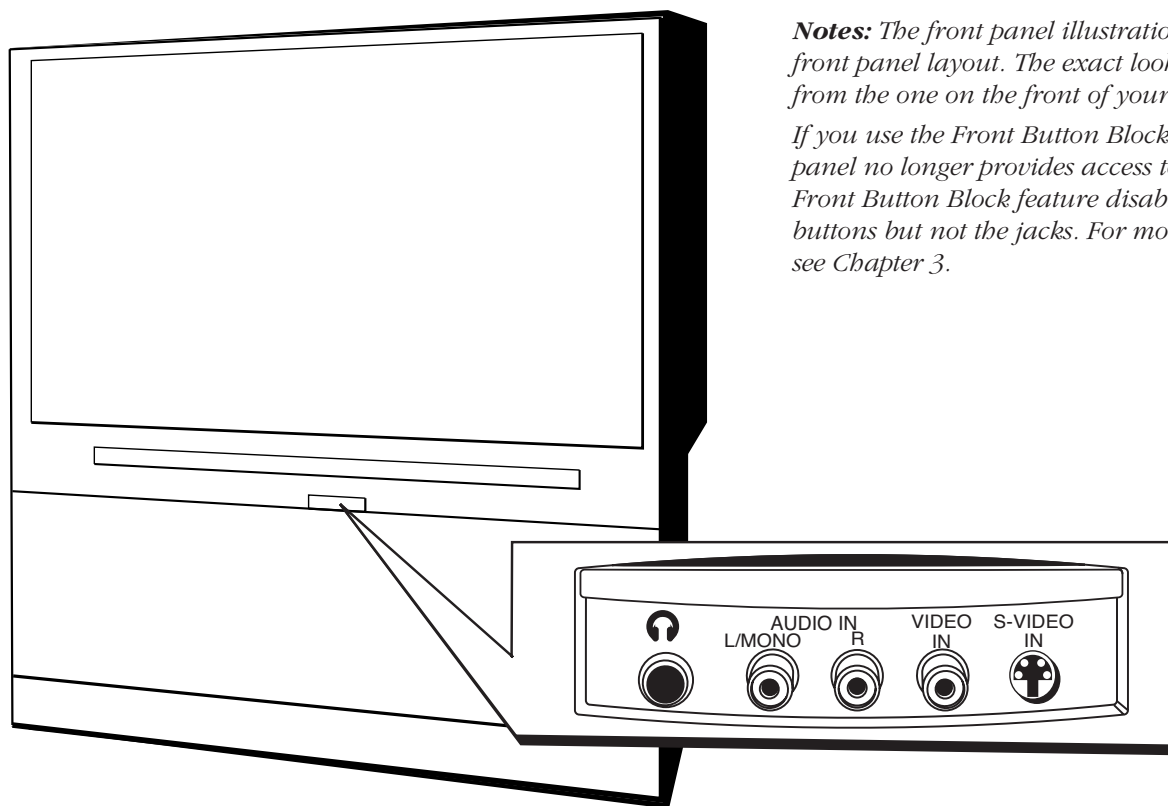

**Notes:** The front panel illustration shows a typical front panel layout. The exact look may be different from the one on the front of your TV.

If you use the Front Button Block feature, the front panel no longer provides access to the menus. The Front Button Block feature disables all front panel buttons but not the jacks. For more information, see Chapter 3.

### Front Panel

If you cannot locate your remote, you can use the front panel of your TV to operate many of the TV's features.

**MENU/OK** Brings up the Main menu. When the menu system is displayed, pressing MENU/OK selects highlighted items.

**CH▼** Scans down through the channel list. In the menu system, it moves the highlight down and adjusts menu controls.

**CH▲** Scans up through the current channel list. In the menu system, it moves the highlight up and adjusts menu controls.

**VOL◀** Decreases the volume. In the menu system, it moves the highlight left to items and adjusts menu controls.

**VOL▶** Increases the volume. In the menu system, it moves the highlight right to items and adjusts menu controls.

**⏻** (Power button) Turns the TV on and off. The indicator lights when TV is on.

# Connections & Setup

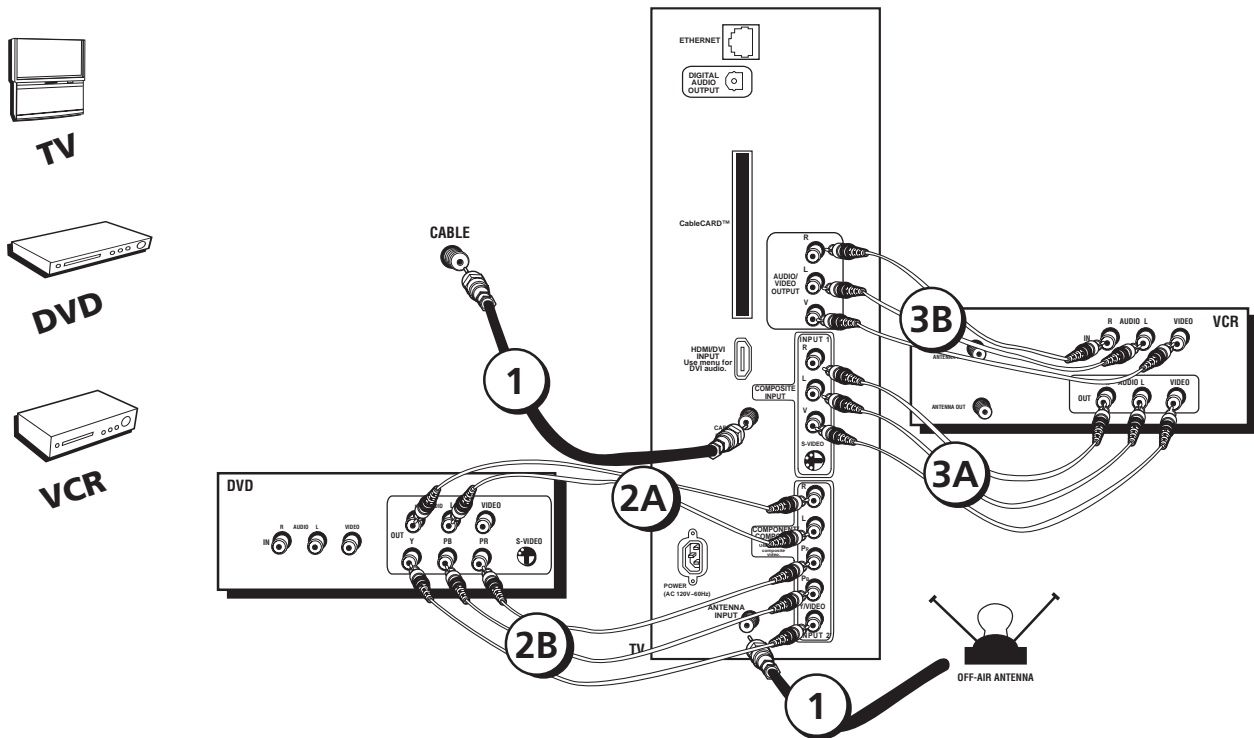

## How to Connect: TV + VCR + DVD Player

### 1. Connect your cable and/or off-air antenna.

If you have cable and an off-air antenna, connect the cable signal to CABLE INPUT. Connect the off-air antenna to ANTENNA INPUT.

### 2. Connect your DVD Player to your TV.

A. Connect the audio (white and red) cables to the INPUT 2 R and L Audio jacks on the back of the TV and to the Audio Output jacks on the DVD player.

B. Connect three video grade cables to the INPUT 2 Y/VIDEO P<sub>B</sub> P<sub>R</sub> jacks on the back of the TV and to the Y P<sub>B</sub> P<sub>R</sub> outputs on the DVD player. If your DVD player doesn't have Y P<sub>B</sub> P<sub>R</sub>, use the INPUT 2 Y/VIDEO jack instead.

**Notes:** If you are using component video cables, you must also connect audio cables. The component video cables only transfer video information.

If your DVD player has a component video output, we recommend you use the component video input on the TV instead of the composite video connection.

### 3. Connect your VCR to your TV.

A. Connect the VCR's audio/video outputs to INPUT 1 (R and L-Audio, and V-Video) on the TV using composite audio/video cables.

B. Connect the VCR's audio/video inputs to the AUDIO/VIDEO OUTPUT jacks on the TV. This enables recording of digital and analog programs (except copy protected or component video formats).

## Viewing the Components

1. Turn on the TV and the component(s) you want to view.
2. Press the TV button on the remote control.
3. Press the INPUT button on the remote control to scroll through the Video Input Channels.
  - View the VCR on the INPUT 1 channel.
  - View the DVD player on the INPUT 2 channel.

**Note:** You can set up the TV to automatically tune to the correct Video Input Channel. This is called Auto Tuning. (See Chapter 3 for more information.)

Go to page 16

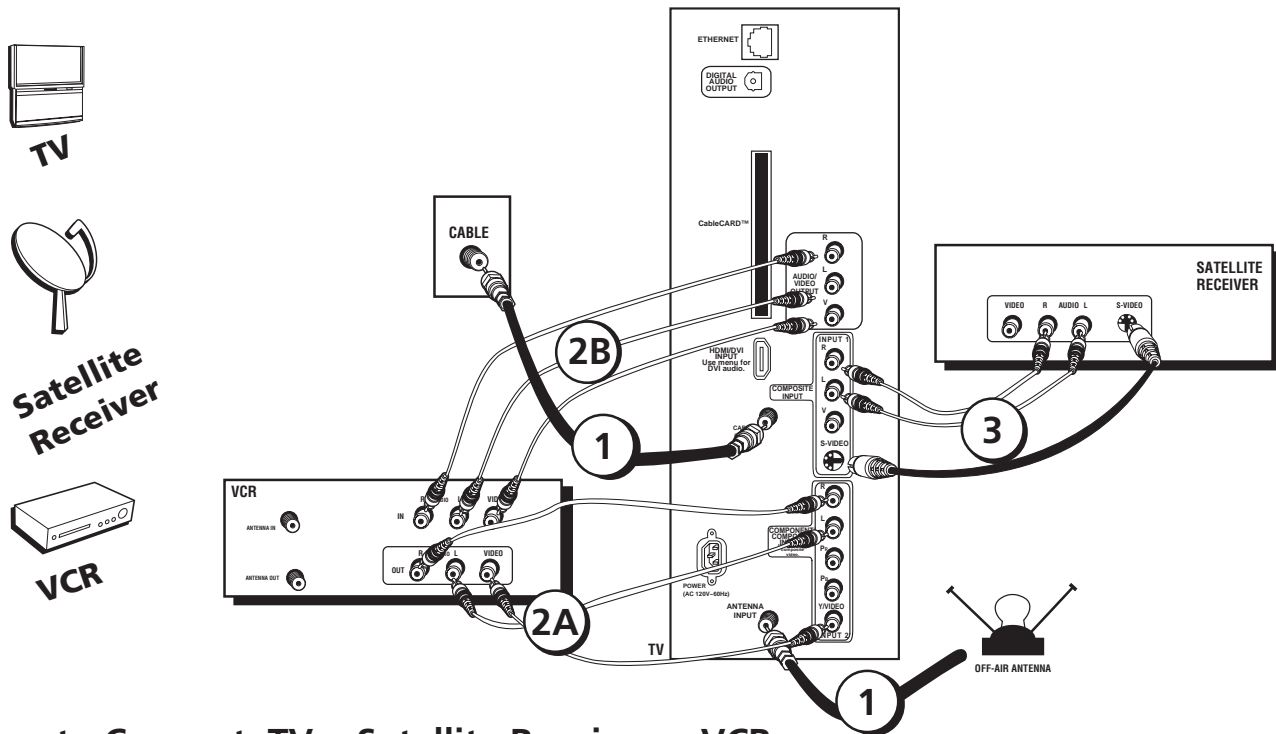

## How to Connect: TV + Satellite Receiver + VCR

### 1. Connect your cable and/or off-air antenna.

If you have cable and an off-air antenna, connect the cable signal to CABLE INPUT. Connect the off-air antenna to ANTENNA INPUT.

### 2. Connect your VCR to your TV.

A. Connect the VCR's audio/video outputs to INPUT 2 (R and L-Audio, and V-Video) on the TV using composite audio/video cables.

B. Connect the VCR's audio/video inputs to the AUDIO/VIDEO OUTPUT jacks on the TV. This enables recording of digital and analog programs (except copy protected or component video formats).

### 3. Connect your Satellite Receiver to your TV.

Connect the satellite receiver's audio output jacks to the INPUT 1 R and L Audio jacks and the S-Video output jack to the S-VIDEO jack on the TV using audio cables and an S-Video cable. If your satellite receiver doesn't have an S-Video output, you can make the video connection by using the V (Video) jack instead.

**Note:** If you are using an S-Video cable, you must also use audio cables. The S-Video cable only transfer video information.

## Viewing the Components

1. Turn on the TV and the component(s) you want to view.
2. Press the TV button on the remote control.
3. Press the INPUT button on the remote control to scroll through the Video Input Channels.
  - View the VCR on the INPUT 2 channel.
  - View the satellite receiver on the INPUT 1 channel.

**Note:** You can set up the TV to automatically tune to the correct Video Input Channel. This is called Auto Tuning. (See Chapter 3 for more information.)

Go to page 16

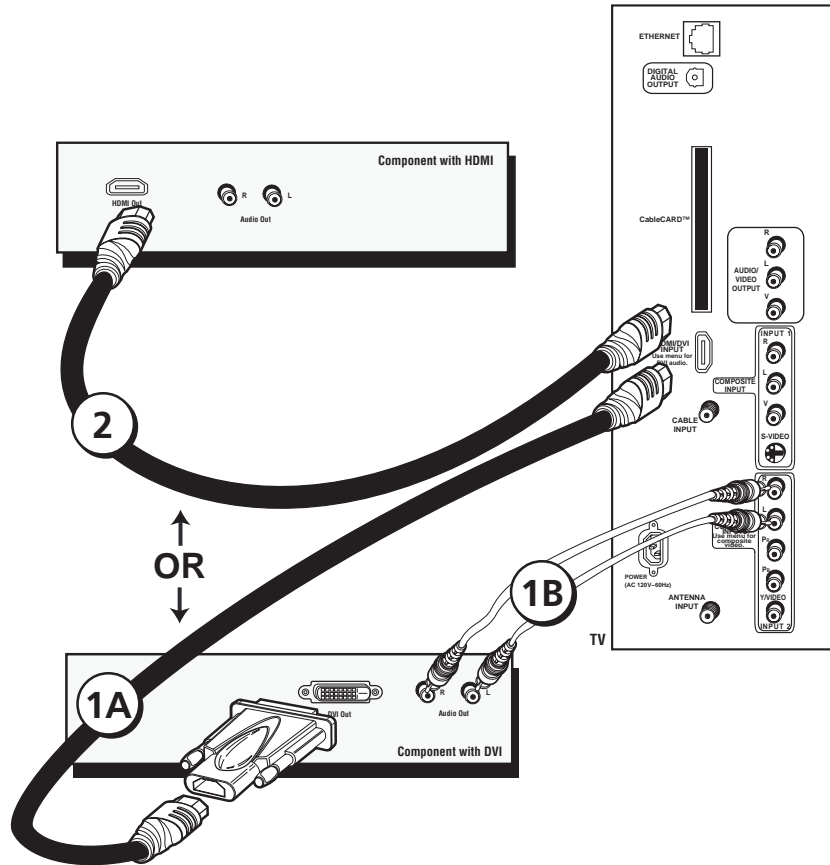

## How to Connect: TV + Component with DVI or HDMI

High-Definition Multimedia Interface (HDMI) is an uncompressed digital interface that carries both video and audio data by way of an integrated mini-plug cable. Since HDMI is based on Digital Visual Interface (DVI), the jack on the back of your TV is also compatible with DVI components.

### 1. To connect your TV to a component with a DVI jack, use an HDMI cable and an HDMI/DVI adapter.

A. Connect the HDMI cable to the HDMI/DVI INPUT jack on the back of the TV. Attach the HDMI/DVI adapter to the end of the HDMI cable, then connect the adapter to the DVI Out jack on the back of the component.

B. Since you're using an HDMI/DVI adapter, you need to connect Audio left and right cables to the R and L jacks on the back of the component and to R and L Audio jacks that aren't in use on the back of the TV.

C. Go to the *DVI Audio Input* option in the *Audio Connections* menu to select which Audio Input you're using.

### 2. To connect your TV to a component with an HDMI jack, use an HDMI cable.

Connect the HDMI cable to the HDMI/DVI INPUT jack on the back of the TV and to the HDMI Out jack on the back of the component.

## Viewing the Component

1. Turn on the TV and the component you want to view.
2. Press the TV button on the remote control.
3. Press the INPUT button on the remote control to select HDMI/DVI Video Input Channel.

**Note:** You can set up the TV to automatically tune to the correct Video Input Channel. This is called *Auto Tuning*. (See Chapter 3 for more information.)

Go to page 16



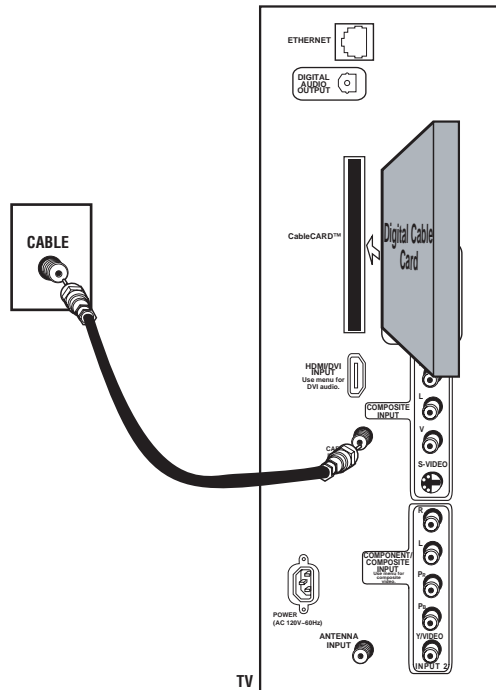

*FCC Statement: This digital television is capable of receiving analog basic, digital basic and digital premium cable television programming by direct connection to a cable system providing such programming. A security card provided by your cable operator is required to view encrypted digital programming. Certain advanced and interactive digital cable services such as video-on-demand, a cable operator's enhanced program guide and data-enhanced television services may require the use of a set-top box. For more information, call your local cable operator.*

## How to Connect: TV + CableCARD

The CableCARD slot allows you to use a digital cable television card to receive digital cable services, including premium and HDTV cable channels, without the need for a set-top box. Please contact your local cable company for availability of services and to obtain a digital cable television card.

When you receive the digital cable card, make sure you connect your coaxial cable to the CABLE INPUT jack. Then, turn on your TV. Insert the digital cable card into the slot on the back of the TV labeled CableCARD. Push firmly on the card until almost the entire card is inserted. Wait to receive information on-screen regarding your digital cable television services. See below for information on setting up digital cable television services for your TV.

### You should know:

- Once the digital cable card is authorized for a particular TV, the card can't be used with any other TV, unless it is re-authorized to it.
- You won't receive digital cable channels if you connect your cable to the ANTENNA INPUT. Make sure you connect your cable to the CABLE INPUT.
- Once inserted, it is not recommended you remove the digital cable card. In the case it needs to be removed, grasp firmly, and pull the card straight out.

## Setting Up Digital Cable Television Service

Once you have connected a digital cable card to the CableCARD slot on the back of the TV (explained above), you are ready to receive digital cable channels. Wait approximately 30 seconds for the status screen to appear. Write down the information you see and call your cable company to provide them with the information on-screen.

**Notes:** *If your information screen disappears before you have a chance to write down the information, press MENU on the remote to access the menu system. Then press 9, 9, 9, and the information screen appears. Go to page 52 for more information on the CableCARD Tools menu.*

*You can't order video-on-demand through your digital cable card. Call your local cable company to place an order.*

**Go to page 16**

## Plug in the TV

Plug the flat end of the cable into the power jack on the back of the TV. Then plug the other end of the power cord into an appropriate wall outlet. Be sure to insert the plug completely. Do not plug the TV into an outlet controlled by a light switch.

**Note:** When you first plug your TV into an outlet, the Power indicator on the front panel will light for approximately 15 seconds and then go off during the initialization of the TV. The TV can only be turned on after the Power indicator goes off. This happens every time the TV is unplugged and plugged back in.

## Put Batteries in the Remote

- Remove the battery compartment cover from the back of the remote by pushing down on the tab and lifting cover.
- Insert 2 fresh “AAA” batteries. Make sure the polarities (+ and -) are aligned correctly with the polarities inside the remote.
- Replace the cover.

## Turn on the TV

Press TV on the remote, or press the Power button on the TV's front panel.

**Note:** Pressing the TV button turns on the TV and puts the remote into TV mode. “TV mode” means that the buttons on the remote control operate the TV's functions.

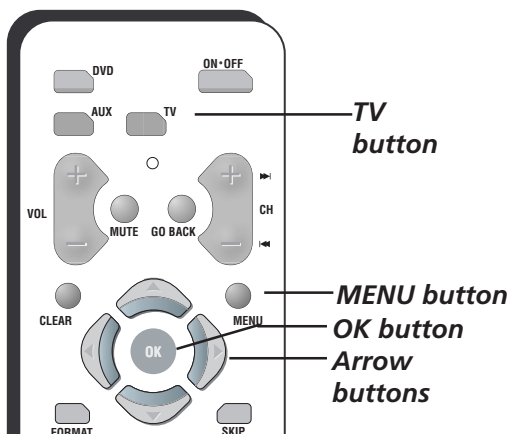

## Use the Remote Control to Complete the Assisted Setup

The technical term is “Navigation” – how you move through the on-screen menus. The method is the same throughout the menu screens: highlight your choice and select it.

To highlight a menu item, put the remote into TV mode by pressing the TV button then MENU. Press the arrow buttons on the remote to highlight one of the items listed in the menu. Use the up or down arrow button to move up or down. Use the right or left arrow button to move right or left.

To select the item that you've highlighted, press OK.

**Note:** Highlighted means that the menu item stands out from other menu items on the list (appears darker, brighter, or a different color).

---

### Tip

To access the setup menus, press MENU and choose Assisted Setup.

---

## Complete the Assisted Setup

Your TV's menu system allows you to adjust your TV's features to be configured to work properly. On-screen information helps you choose settings to match your setup. The first time you turn on your TV, the Assisted Setup screens appear automatically. Select *Begin Setup* to start or select *Cancel Setup* to exit.

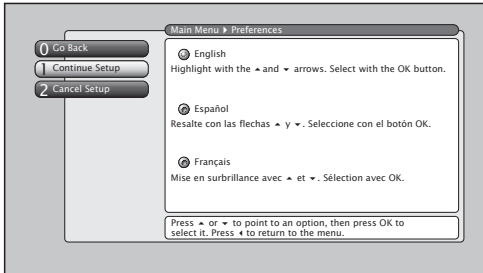

## Set the Menu Language

1. Use arrow buttons to highlight your preferred language for the menu system.
2. Press OK to select that language.
3. Select *Continue Setup*.

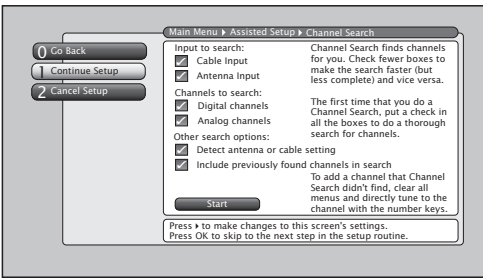

## Complete Channel Search

Even though this initial channel search can take several minutes, it is important to complete in order for your TV to display channels and programming. Make sure you have connected cable and/or off-air antenna to the corresponding inputs before you start channel search.

1. To do a complete channel search, check each box that pertains to your TV. For example, if you're only receiving cable from the CABLE INPUT, highlight *Cable Input* and press OK to place a checkmark in the box.
2. Select *Start* to begin the setup.
3. When the channel search is complete, a message screen appears. Select *Continue*. Another message screen appears telling you that you've completed the Assisted Setup. Select *Continue* on the left.

**Notes:** *If you skip Channel Search now, you can access it later through the Connections menu. See Chapter 4 for more details.*

*If cable box or CableCARD is connected to your TV's CABLE INPUT, Channel Search won't work for it.*

### Tip

*The first Channel Search takes several minutes if the TV is searching for analog and digital channels and Cable and Antenna inputs are being searched. You may want to leave and come back later.*

## Changing Channels

Depending upon the type of signals you have connected to your HDTV, you might notice that the channels change slower than you're used to. This is perfectly normal. Your HDTV is able to interpret and display both analog (NTSC) and digital off-air and cable signals (QAM and ATSC).

## Next Steps

Now that you've finished the *Assisted Setup*, you're ready to watch TV. This might be a good time to program your remote control. The remote control that came with this TV can be programmed to operate other components. Go to the next chapter to find out how to program your remote.

- Chapter 2: Using the Remote Control
- Chapter 3: Using the TV's Features
- Chapter 4: Using the TV's Menu System
- Chapter 5: Reference

*This page intentionally left blank*

# Using the Remote Control

## Chapter Overview:

- The Buttons on the Remote Control
- Programming the Remote to Operate Other Components
- How To Use the Remote After You've Programmed It
- Using the INPUT button
- Remote Code List

Changing Entertainment. Again.



# Using the Remote Control

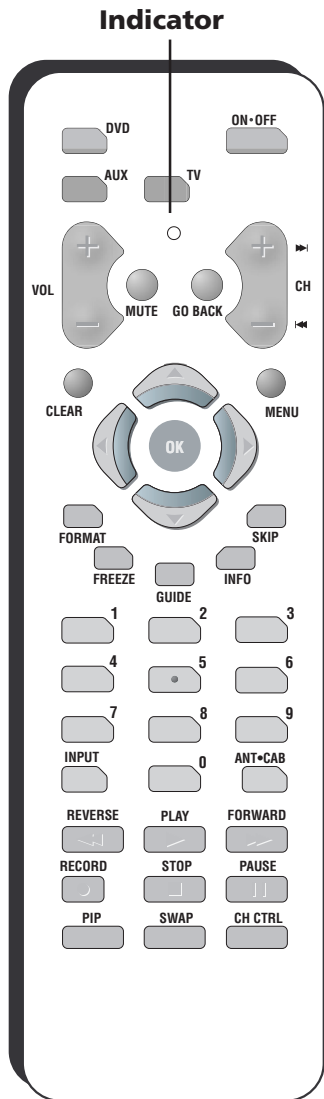

## The Buttons on the Remote Control

**Arrows (up, down, left, right)** Used to move through the on-screen menus. Also moves the PIP window, see page 38 for more information.

**Indicator** Indicates the programming mode when programming the remote to control components. Lights when you press a valid button on the remote. Flickers when a button is pressed and the batteries are low.

**(0-9) Number Buttons** Enter channel numbers and time settings. Also used in the TV menu to make selections.

**ANT•CAB** Switches between Antenna and Cable Input. In VCR mode, functions as a TV/VCR button. In SAT mode, functions as a TV/SAT button for an RCA satellite receiver. When tuned to an input, press to go back to the most recently used tuner (Antenna or Cable Input).

**AUX** Places the remote in auxiliary mode to operate a component (such as a cable box, satellite receiver, VCR, DVD, or audio receiver) that you've programmed to work with this button. AUX by default is set up for an RCA VCR. Use the VCR2 option in the *Auto Tuning* menu to auto tune to your VCR.

**CH + or CH -** Scrolls up or down through the channel or input list. Press once to change the channel up or down; press and hold to continue changing channels.

**CH CTRL (Channel control)** Toggles the channel control between the main TV picture and the PIP window. Use channel up, channel down, INPUT, component buttons, or number buttons to change channels in PIP. CH CTRL is marked by a triangle (▷) in the banner.

**CLEAR** Removes on-screen menus and displays. Cancels the commercial skip timer.

**DVD** Places the remote in DVD mode. If Auto Tuning is enabled, pressing the DVD button turns on the TV and tunes to the correct Video Input Channel.

**FORMAT** Toggles through the 4:3 video screen formats (Normal, Zoom, Stretch, Cinerama, and Auto Format) for some 4:3 signals—not applicable to 16:9 signals.

**FREEZE** Freezes entire screen, including the main picture and PIP window, if PIP is displayed. When recording from AUDIO/VIDEO OUTPUT, freezes digital, but not analog channels.

**GO BACK** Returns you to the previous channel or previous screen in the menu system. Also, toggles between antenna and input sources.

**GUIDE** If you're controlling another component that has a guide, this accesses the on-screen guide.

**INFO** Brings up the Channel Banner with channel and viewing information. Press again to remove the banner.

### Tip

The DVD button turns on most RCA, GE, and Proscan products.

# Using the Remote Control

## Tip

To turn off most RCA, GE, and Proscan components that are connected to the TV, press ON•OFF twice within two seconds and hold remote steady until indicator turns off.

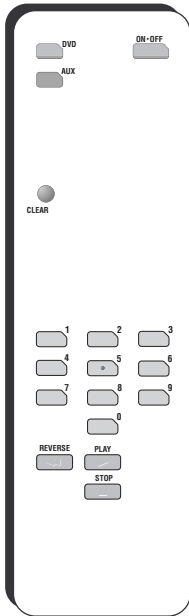

You'll use these buttons when you program the remote for other components.

**Important Note:** The remote may not be compatible with all models of all brands of components. It also may not operate all functions of your component.

## Tip

By default, the AUX button is programmed for an RCA VCR (VCR2). If auto tuning is set up, it will tune to VCR2 input channel.

**INPUT** Toggles through the TV's available input sources (INPUT 1, INPUT 2, Front Input, HDMI/DVI, and last-active channel). To quickly access an input, press the INPUT button and the input number, for example, INPUT +1 to access INPUT 1.

**MENU** Makes *Main Menu* appear and disappear.

**MUTE** Reduces the TV's volume to its minimum level. Press again to restore volume.

**OK** When a menu item is highlighted, press OK to select the item.

**ON•OFF** Turns the TV on or off. In other modes (DVD or AUX), and if programmed, turns the component on and off.

**PIP** Makes the PIP window appear and disappear (See Chapter 3 for more information about using PIP).

**REVERSE, PLAY, FORWARD, RECORD, STOP, PAUSE** If programmed, provides transport control for some remote-controllable VCRs and CD and DVD players.

**SKIP** Press once before changing channels and the TV returns to the original channel after 30 seconds. Press repeatedly to add more time. Press CLEAR to cancel.

**SWAP** When using PIP, switches the main picture with the PIP window.

**TV** Places the remote in TV mode. Turns on the TV and tunes to the last-viewed TV channel or input.

**VOL – or VOL +** Decreases or increases the TV's volume.

## Programming the Remote to Operate Other Components

The universal remote can be programmed to operate many brands of remote-controllable VCRs, audio components, DVD players, cable boxes, satellite receivers and other components. In addition to being programmed to operate your television, it's already programmed to operate most RCA, GE, and Proscan components.

The AUX button can be programmed to operate most brands of an additional remote-controllable component: satellite receiver, cable box, DVD, VCR, and an audio component. A second and third RCA TV can be programmed to any component button, except the TV button. Go to page 52 for more information on programming the remote to another TV.

**Note:** The TV button can't be programmed on this remote to control any component; it controls only this TV.

# Using the Remote Control

---

## Find Out If You Need to Program the Remote

To determine whether the universal remote needs to be programmed to operate one of the components connected to your TV, such as a DVD player, do the following:

1. Turn on the component (in this example, a DVD player).
2. Point the remote at the component.
3. Press the corresponding component button (in this example, DVD).
4. Press ON•OFF to see if the DVD player responds. If the DVD player doesn't respond, you need to program the remote to operate it.

## Programming the Remote

There are two ways to program the remote control to operate other components: *Automatic Code Search* and *Direct Entry*.

### Using Automatic Code Search

**Note:** *The AUX button can only search VCR codes, but can be used for a non-VCR device by programming it with direct entry method.*

The following instructions can be used to program the remote to operate each of your components. If you want to stop the automatic code search without programming any of your components, press and hold CLEAR until the indicator on the remote turns off.

1. Turn on the component you want to operate (VCR, DVD player, etc.)
2. Press and hold the component button you want to program (AUX or DVD). While holding the component button, press and hold ON•OFF until the indicator on the remote turns on, then release both buttons.
3. Point the remote at the component.
4. Press and release PLAY, then wait 5 seconds or until the indicator stops flashing.

At this point the remote is searching for the correct code to program. If, after 5 seconds, the component you want to operate does not turn off, press PLAY again to tell the remote to search the next set of codes.

Continue pressing and releasing PLAY until the component turns off or you have searched through all of the codes. The indicator turns off when all codes have been searched and remote exits Automatic Code Search.

If the component you want to control *does* turn off:

1. Press and release REVERSE, then wait 2 seconds. Repeat this step until the component turns back ON.
2. To finish, press and hold STOP until the component button on the remote turns off.



## Using Direct Entry

1. Turn on the component you want to operate (VCR, DVD player, etc.)
  2. Look up the brand and code number(s) for the component on the code list in this section.
  3. Press and hold the component button you want to program on the remote.
  4. Enter the 4-digit code from the remote control code list on the following pages. If the indicator flashes, you have either entered an invalid code or the button isn't programmable.
  5. Release the component button, point the remote at the component, and then press ON•OFF to see if the component responds to the command. If it doesn't, try pressing the component button and then ON•OFF again.
- If you get no response, repeat these steps using the next code listed for your brand, until the component responds to the remote commands.
  - If you try all the codes for your component brand and none work, try the automatic code search method. If automatic code search doesn't find the code, the remote is not compatible with your component.

## How to Use the Remote After You've Programmed It

Because this remote can control several different components (TV, DVD, VCR, satellite receiver, etc.), it uses operational modes triggered by the component buttons.

1. Press the appropriate component button (DVD or AUX) to set the remote to control the component.
2. Press ON•OFF to turn the component ON or OFF.
3. Use the remote buttons that apply to that component.

**Notes:** *The remote control may not be compatible with all brands and models of components.*

*If you keep pressing buttons and nothing happens, the remote is probably in the wrong mode. You must press the component button that matches the component you want to operate (i.e., if you want to operate the DVD player, press DVD on the remote control to put the remote in DVD mode.)*

# Using the Remote Control

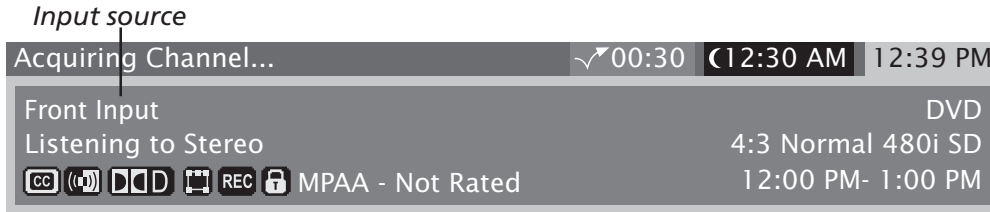

**Note:** Watch the Channel Banner to see the input sources change each time you press the INPUT button.

## Using the INPUT Button

1. Repeatedly press the INPUT button to scroll through the available input sources until you find the input associated with the component (such as VCR or DVD player) you want to view.
2. Once you find the input source you want, stop pressing INPUT.
  - If you tune to INPUT 1 and your VCR is connected to that input, you will be able to view your VCR. To play, stop, or rewind the VCR tape using the remote that came with your TV, you must first press the AUX button to put the remote control in VCR mode.

There are other ways of selecting a Video Input Channel:

- Program the component buttons (AUX or DVD) on the remote control to automatically tune to the correct Video Input Channel when pressed. For more details on Auto Tuning, see Chapter 3.
- When viewing an input, press ANT•CAB, GO BACK, or INPUT to go back to viewing channels or use the number buttons to enter the channel number.
- To quickly access an input, press the INPUT button and the input number, for example, INPUT + 1 to access INPUT 1.

## Remote Code List

### VCR Codes

Programmable for AUX button.		
Admiral .....	2132	DBX .....
Adventura .....	2026	2009, 2010
Aiko .....	2027	Dimensia .....
Aiwa .....	2026	2000, 2131
Akai ... 2003, 2004, 2005, 2007, 2008, 2111, 2112, 2113		Dynatech .....
American High .....	2021	2026
Asha .....	2013	Electrohome .....
Audio Dynamics .....	2009, 2010	2014, 2029
Audiovox .....	2014	Electrohome .....
Bell & Howell .....	2011	2014
Beaumarck .....	2013	Emerson .....
Broksonic .....	2012, 2025	2012, 2014, 2015, 2021, 2024, 2025,
Calix .....	2014	2026, 2029, 2030, 2031, 2032, 2033, 2034, 2035,
Candle .....	2013, 2014, 2015, 2016,	2036, .....
.....	2017, 2018, 2019	2037, 2038, 2039, 2040, 2041, 2042, 2044,
Canon .....	2021, 2022, 2114	2045, 2046, .....
Capehart .....	2020, 2110	2047, 2065, 2113,
Carver .....	2062	2116, 2117, 2130
CCE .....	2027, 2061	Fisher ....
Citizen .....	2013, 2014,	2011, 2023, 2048, 2049, 2050, 2051, 2052, 2118
.....	2015, 2016, 2017, 2018, 2019, 2027	Fuji .....
Colorlyme .....	2009	2021, 2119
Colt .....	2061	Funai .....
Craig .....	2013, 2014, 2023, 2061	2026
Curtis-Mathes .....	2000, 2009, 2013,	Garrard .....
.....	2016, 2018, 2021, 2022, 2024, 2115, 2131	2026
Cybernex .....	2013	GE .....
Daewoo ....	2015, 2017, 2019, 2025, 2026, 2027, 2028,	2000, 2001, 2013,
.....	2110	.....
Daytron .....	2110	2021, 2022, 2053, 2115, 2120, 2131
		Goldstar .....
		2009, 2014, 2018, 2054
		Gradiente .....
		2026
		Harley Davidson .....
		2026
		Harman Kardon .....
		2009
		Harwood .....
		2061
		Headquarter .....
		2011
		Hitachi .....
		2055, 2056,
		.....
		2057, 2107, 2111, 2120, 2122
		Hi-Q .....
		2023
		Instant Replay .....
		2021
		JCL .....
		2021
		JC Penney .....
		2009, 2010, 2011, 2013,
		.....
		2014, 2021, 2022, 2055, 2056,
		.....
		2058, 2059, 2060, 2107, 2118
		Jensen .....
		2055, 2056, 2111
		JVC .....
		2009, 2010, 2011, 2018, 2111, 2123
		Kenwood .....
		2009, 2010, 2011, 2016, 2018, 2111, 2123
		KLH .....
		2061
		Kodak .....
		2014, 2021
		Lloyd .....
		2026
		Logik .....
		2061
		LXI .....
		2014
		Magnavox .....
		2021, 2022, 2062,
		.....
		2063, 2104, 2105, 2108, 2124
		Magnin .....
		2013
		Marantz ...
		2009, 2010, 2011, 2016, 2018, 2021, 2062, 2064
		Marta .....
		2014
		Masushita .....
		2021
		Mei .....
		2021
		Memorex .
		2011, 2013, 2014, 2021, 2023, 2026, 2104, 2132
		MGA .....
		2029, 2065, 2113
		MGN Technology .....
		2013
		Midland .....
		2053
		Minolta .....
		2055, 2056, 2107
		Mitsubishi .....
		2029, 2055, 2056, 2065, 2066, 2067, 2068,
		.....
		2068, 2070, 2071, 2072, 2073, 2074, 2106, 2113, 2123
		Montgomery Ward .....
		2075, 2132
		Motorola .....
		2021, 2132
		MTC .....
		2013, 2126
		Multitech .....
		2013, 2016, 2026, 2053, 2061
		NEC .....
		2009, 2010, 2011, 2016, 2018,
		.....
		2064, 2076, 2078, 2079, 2111, 2123
		Nikko .....
		2014
		Noblex .....
		2013
		Olympus .....
		2021

# Using the Remote Control

Optimus .....	2014, 2132
Optonica .....	2096
Panasonic .....	2021, 2022, 2109, 2125, 2126, 2127
Pentax .....	2016, 2055, 2056, 2107, 2120
Pentax Research .....	2018
Philco .....	2021, 2022, 2062, 2063
Philips .....	2021, 2062, 2096, 2124
Pilot .....	2014
Pioneer .....	2010, 2055, 2080, 2081, 2123
Portland .....	2016, 2017, 2019, 2110
Proscan .....	2000, 2001, 2131
Protec .....	2061
Pulsar .....	2104
Quarter .....	2011
Quartz .....	2011
Quasar .....	2021, 2022, 2125
RCA .....	2000, 2001, 2003, 2013, 2021, 2055, 2056, 2082, 2083, 2084, 2085, 2086, 2087, 2088, 2089, 2090, 2091, 2107, 2115, 2120, 2125, 2131, 2133
Radioshack/Realistic .....	2011, 2013, 2014, 2021, 2022, 2023, 2026, 2029, 2049, 2050, 2096, 2132
Radix .....	2014
Randex .....	2014
Ricoh .....	2128
Runco .....	2104
Samsung .....	2005, 2013, 2015, 2033, 2053, 2112
Sanky .....	2104, 2132
Sansui .....	2010, 2092, 2111, 2123
Sanyo .....	2011, 2013, 2023
Scott .....	2012, 2015, 2025, 2032, 2038, 2065, 2093, 2116
Sears .....	2011, 2014, 2021, 2023, 2048, 2049, 2050, 2051, 2055, 2056, 2107, 2118
Sharp .....	2017, 2029, 2094, 2095, 2096, 2097, 2132
Shintom .....	2004, 2056, 2061, 2098
Shogun .....	2013
Signature .....	2132
Singer .....	2021, 2061, 2128
Sony .....	2004, 2098, 2099, 2119
STS .....	2021, 2107
Sylvania .....	2021, 2022, 2026, 2062, 2063, 2065, 2124
Symphonic .....	2026
Tandy .....	2011
Tashiko .....	2014
Tatung .....	2111
TEAC .....	2026, 2085, 2111
Technics .....	2021, 2109
Teknika .....	2014, 2021, 2026, 2100, 2129
TMK .....	2013, 2024, 2047
Toshiba .....	2015, 2049, 2051, 2055, 2065, 2093, 2116
Totevsiion .....	2013, 2014
Unitech .....	2013
Vector Research .....	2009, 2010, 2015, 2016
Victor .....	2010
Video Concepts .....	2009, 2010, 2015, 2016, 2113
Videosonic .....	2013
Wards .....	2013, 2014, 2015, 2021, 2023, 2026, 2029, 2055, 2056, 2061, 2096, 2101, 2102, 2103, 2107, 2116, 2132
XR-1000 .....	2021, 2026, 2061
Yamaha .....	2009, 2010, 2011, 2018, 2111
Zenith .....	2004, 2098, 2104, 2119, 2128

## DVD codes

Programmable for the DVD and AUX buttons.	
Aiwa .....	3009
Apex .....	3023, 3024
GE .....	3000
Hitachi .....	3008
JVC .....	3002, 3010
Konka .....	3011, 3012
Magnavox .....	3003
Mitsubishi .....	3004
Panasonic .....	3013
Philips .....	3003, 3019, 3021, 3022
Pioneer .....	3005
Proscan .....	3000
RCA .....	3000, 3001
Samsung .....	3025
Sanyo .....	3014
Sony .....	3006, 3015, 3016
Toshiba .....	3007, 3017, 3020
Zenith .....	3018

## Cable Box Codes

Programmable for the AUX button.	
ABC .....	5002, 5003, 5004, 5005, 5006, 5053
Antronix .....	5008, 5009
Archer .....	5008, 5009, 5010
Cabletenna .....	5008
Cableview .....	5008
Colour Voice .....	5012, 5013
Comtronics .....	5014
Contec .....	5016
Eastern .....	5017
GC Electronics .....	5009
GE .....	5000, 5001
Gemini .....	5018, 5019
General Instrument .....	5003
Hamlin .....	5020, 5021, 5022, 5028, 5035, 5045
Hitachi .....	5003
Jerrold .....	5003, 5018, 5023, 5024, 5046, 5053
Magnavox .....	5025
Memorex .....	5026
Movie Time .....	5027
NEC .....	5005
NSC .....	5027
Oak .....	5016, 5029
Panasonic .....	5048, 5052
Philips .....	5011, 5012, 5013, 5015, 5019, 5025, 5030, 5031, 5032
Pioneer .....	5033, 5034
Proscan .....	5000, 5001
RCA .....	5007, 5047, 5049, 5052
Realistic .....	5009
Regal .....	5022, 5035
Regency .....	5017
Rembrandt .....	5003
Samsung .....	5034
Scientific Atlanta .....	5006, 5036, 5037, 5038
Signal .....	5018
Signature .....	5003
Sprucer .....	5052
Standard Components .....	5039, 5044
Starcom .....	5018, 5053
Stargate .....	5018
Starquest .....	5018
Tandy .....	5040
Television .....	5014
Tocom .....	5004, 5023
Tusa .....	5018
TV86 .....	5027
Unika .....	5008, 5009
United Cable .....	5053
Universal .....	5008, 5009, 5010
Viewstar .....	5025, 5027
Zenith .....	5050, 5051

## Satellite Receiver Codes

Programmable for the AUX button.	
Alphastar .....	5079
Chapparral .....	5056, 5057
Dishnet .....	5078
Drake .....	5058, 5059
Echostar .....	5089
GE .....	5000, 5001
General Instruments .....	5060, 5061, 5062
Hitachi .....	5083, 5084
Hughes .....	5077, 5090
JVC .....	5082
Panasonic .....	5075
Philips .....	5085
Primestar .....	5076
Proscan .....	5000, 5001
RCA .....	5000, 5001, 5071, 5080, 5081
Realistic .....	5063
Sony .....	5072
STS1 .....	5064
STS2 .....	5065
Toshiba .....	5068, 5073
Uniden .....	5069, 5086

## Audio Codes

Programmable for the AUX button.

### RCA and Dimensia

AM/FM .....	4003, 4270
AUX .....	4004
Phono .....	4005
Tape .....	4006
CD .....	4007, 4190, 4211

### Receivers

Aiwa .....	4261, 4262, 4263, 4264, 4265, 4266, 4267, 4277
Denon .....	4283
Harman Kardon .....	4276
JVC .....	4268
JVL .....	4276
Kenwood .....	4269
Onkyo .....	4278
Optimus .....	4284
Panasonic .....	4279, 4280
Pioneer .....	4275
RCA .....	4270
Sherwood .....	4282
Sony .....	4271, 4272, 4281
Technics .....	4279, 4280
Wards .....	4275
Yamaha .....	4274, 4275

## HD Receiver Code

Programmable for the AUX button.

RCA .....	7000, 7001, 7002
Panasonic .....	7003
Philips .....	7004
Samsung .....	7005

## TV Codes

Programmable for the DVD and AUX buttons.

TV2 .....	1222
TV3 .....	1223

*This page intentionally left blank*

# Using the TV's Features

## Chapter Overview:

- About the Channel Banner
- Digital or Analog TV Channels
- Parental Controls
- How V-Chip Works for the USA and Canada
- Auto Tuning Feature
- PIP (Picture-In-Picture) Operation
- Emergency Alert System (EAS)

Changing Entertainment. Again.





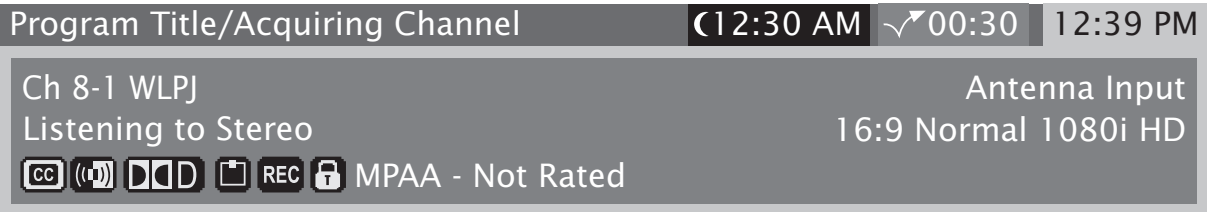



# Using the TV's Features



## About the Channel Banner

The Channel Banner appears when you press the INFO button on the remote. If an icon in the channel banner is grayed out (dim), the feature is not available. The following list describes the items on the Channel Banner screen (left to right and top to bottom). Other displays that are not described here are self-explanatory. When you change channels, the Channel Banner appears as a smaller version than what's shown above.

The icons change appearance to show the item's status or availability.

- Program Title/Acquiring Channel** Title of program (if available) or *Acquiring Channel* appears when tuning a channel.
- 12:30 AM** The time when the TV shuts off if the Sleep Timer is activated in the *Time* menu.
- ✓ 00:30** Displays the time remaining before the TV tunes back to the channel where Commercial Skip was activated.
- 12:39 PM** Current time if it is set in *Time* menu.
- 8-1 WLPJ** Current channel, subchannel (for digital channels) and the TV station call letters, if available.
- Antenna/Cable/Auto Tuning** Displays type of signal (Antenna or Cable) you're viewing or the Auto Tuning component you're viewing.
- Listening to** Displays when SAP is available for analog channel. For a digital channel, displays the currently playing audio mode. Also displays the audio processor in use.
- 16:9 Normal 1080i HD** Aspect ratio (4:3 or 16:9); original resolution of the broadcast, not the resolution of the TV; HD or SD. For more information about aspect ratio and broadcast resolution, go to page 1.
-  Displays when Closed Captioning is available on the current channel and matches the format selected in the *Caption Priority* menu.
-   SAP or Audio mode icon appears when the current analog channel is broadcasting SAP (Second Audio Program) information or when current digital channel is broadcasting an alternate audio mode, respectively.
-   Sound mode icons (mono, stereo, Dolby surround, four-channel surround, 4.1-channel surround, five-channel surround), etc.
-  Appears when a program can be recorded; otherwise, it is grayed out.
-  Parental Control icon is displayed red when the TV is locked, green when the TV is unlocked, and yellow when the TV is temporarily unlocked.
- MPAA - Not Rated** V-chip program rating (not the TV's rating set up in Parental Control menu).

## Digital or Analog TV Channels

A single off-air antenna can pick up both analog and digital channels. Digital channels can be made up of primary channels and subchannels.

**Note:** Subchannels (sometimes called minor channels) are channels associated with the Primary channel (sometimes called the major channel). A primary channel may have just one subchannel or multiple subchannels.

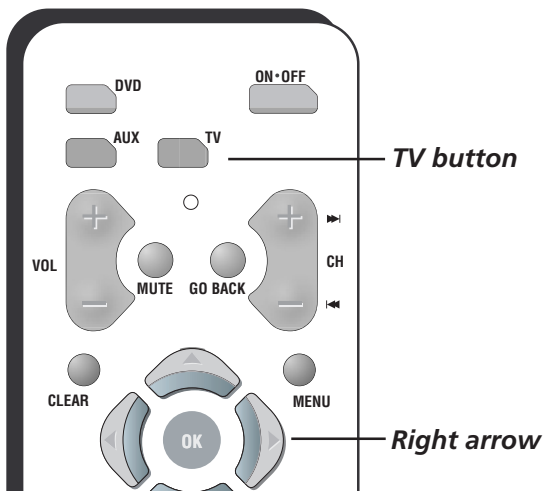
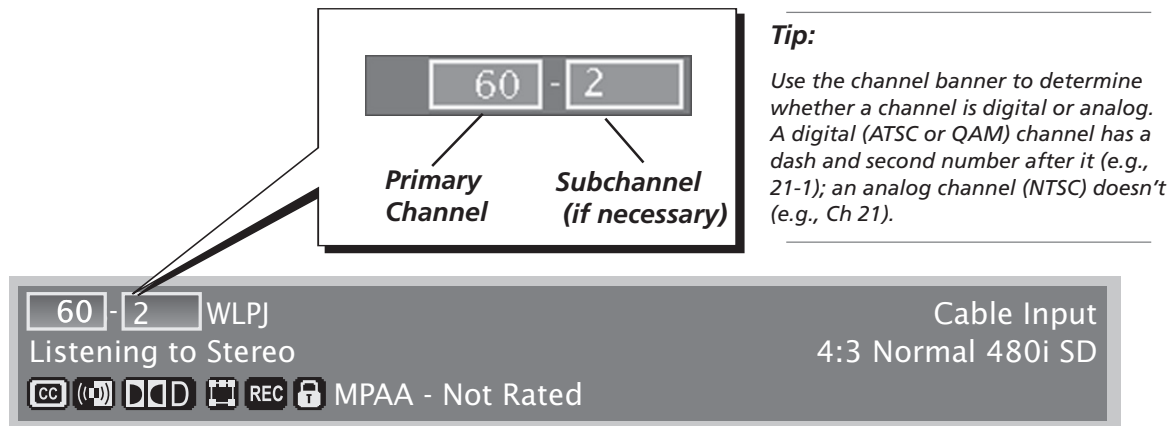

### Tip

If a digital and analog channel have the same primary channel number, tune to the analog channel by entering the analog channel number or entering the analog channel number and then a subchannel of "0."

## Direct Tuning to a Channel

1. Make sure the remote is in TV mode by pressing TV on the remote control.
2. Enter the primary channel number. This number appears in the primary channel entry box. Press OK or wait a few seconds. If you don't enter a subchannel, the TV tunes to the lowest digital subchannel.
3. If the primary channel number has fewer than six digits (for cable) or two digits (for antenna) and you want to enter subchannel numbers, press the right arrow button to advance to the subchannel entry box.
4. Enter the number of the subchannel. This number appears in the subchannel entry box.
5. Press OK to tune to the channel or wait a few seconds and the TV tunes to the channel.

**Notes:** You can always use the channel up and down buttons on the remote control to change channels within the TV mode.

If you wait too long before entering the subchannel, the TV tunes to the lowest digital subchannel.

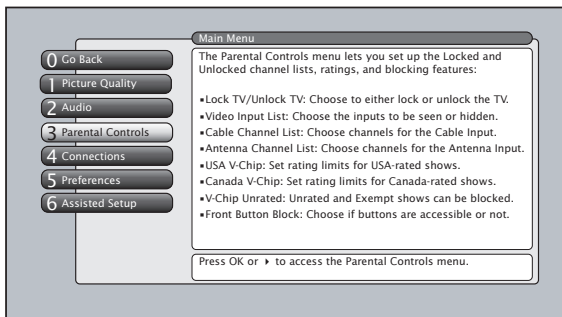

## Parental Controls

The *Parental Controls* menu allows you to program your TV so that children cannot see certain programs, channels, or use the buttons on the front of the TV. The *Parental Controls* menu controls the software inside your TV (referred to as V-Chip) which lets you program your TV so it won't display certain programs and movies based on violence, sex, or other content you may believe children should not view. Once you block programs, you or other adults can unblock programs by entering a password to unlock video or enter the password to edit the features in the *Parental Controls* menu. By default, the software inside your TV is turned "off," so if you don't want to use this feature, you can just ignore it.

The options of the *Parental Controls* menu are *Lock/Unlock TV*, *Video Input List*, *Cable Channel List*, *Antenna Channel List*, *USA V-Chip*, *Canada V-Chip*, *V-Chip Unrated*, and *Front Button Block*.

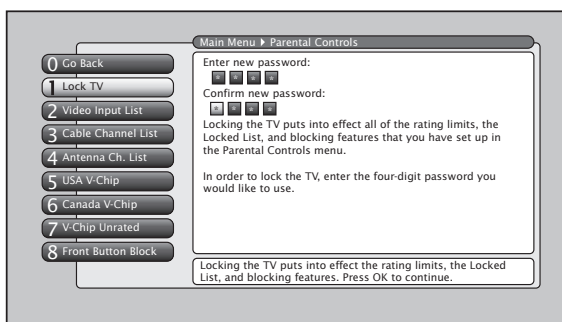

## Lock/Unlock TV

Selecting this option lets you lock and unlock the parental controls and the TV using a password. It locks or unlocks channel lists. If the TV is unlocked when watching TV, you only see the channels that have a check mark in the *Unlocked List* (see Channel Lists below). If the TV is locked when watching TV, you only see the channels that are marked as Viewable in the *Locked List*. If the TV is locked, all channels can still be accessed by using the number buttons on the remote control but may not be viewed if they are blocked (enter password to see program).

**Notes:** When locking the TV, you'll be asked to enter a password and then to re-enter the password a second time to re-confirm your password choice.

If you do not lock the TV, none of the settings for V-Chip, channel block, and front panel block take effect.

If you forget your password, simultaneously press and hold the MENU/OK button on the front panel and VOL- button on the remote for three seconds. This resets the password only and unlocks the TV; all other settings in Parental Controls are not changed.

### Tip

You must lock the TV for the parental controls settings to be enforced.

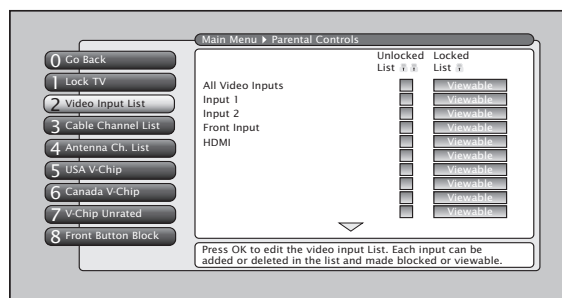
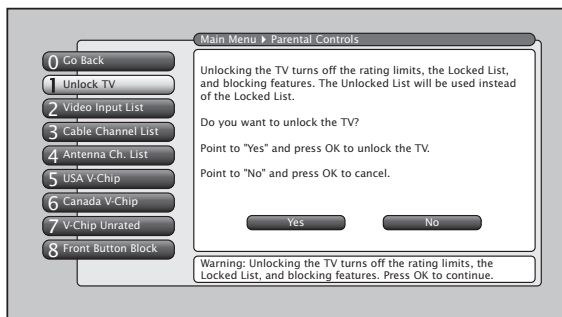

## Channel Lists (Video Input List, Cable Channel List, Antenna Ch. List)

The channel lists contain the following information: major channel number (with subchannel number only if it's a digital channel), channel call letters (when channel is tuned), *Locked List*, and *Unlocked List*. The major channels listed in *Cable Channel List* and *Antenna Ch. List* for off-air or cable sources are based on the channel search results. If a major channel is not found by Channel Search, then it is not listed.



## Editing Channels in the Channel Lists

All the lists can only be edited through the *Unlocked List* and *Locked List* in the *Parental Controls* menu. You can remove or “hide” a channel from the *Unlocked List* by removing the check mark in the box. Also, you can remove or “hide” a channel from the *Locked List* by selecting *Blocked* in the *Locked List*. When you press the channel buttons, that channel will be skipped. When the TV is locked, you can still access the channel directly by using the number buttons on the remote control but may not be able to see the video until a valid password is entered.

To save time, you can also add ALL or delete ALL channels in a list by changing the box or choice field in the line that says *All Video Inputs* or *All Channels* but be very careful because you could erase all of your selections.

**Note:** If a cable box is connected to the *CABLE INPUT*, the channel list can be edited for *Cable Channel* in the *Parental Controls* menu. If a cable box is connected via *INPUT1*, the channel list cannot be edited- you can only use channel up/down or use the number buttons.

## How V-Chip Works for the USA and Canada

The V-Chip software reads a code that most broadcasters send with programs. That code tells the TV software the program's age-based rating (TV-MA, TV-14, etc.) and content themes [(Violence (V), Adult Language (L), etc.)]. If you have blocked the rating and/or content themes that the program contains and the TV is locked and you tune to a program whose rating exceeds the rating limit you set, you will receive a message telling you that the program is not approved for viewing.

Broadcasters are not required to provide content themes, so programs received with no content themes will only be blocked if you block their age-based rating and the TV is locked. With the *V-Chip Unrated* menu, you can also block out programs that have been given a rating of “Not Rated,” or “Exempt” and programs that are considered “unrated”. The TV age-based ratings and content themes you can block are in the table on the next page.

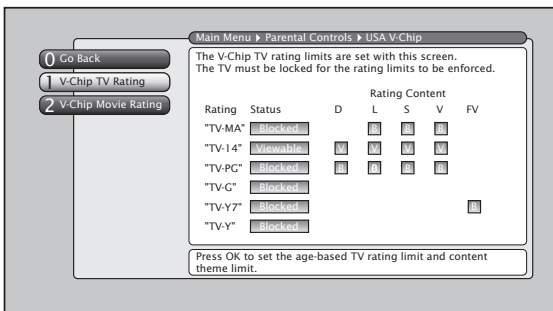

## USA V-Chip TV Ratings

The *USA V-Chip TV Rating* lets you decide which TV programs can and cannot be viewed. To set TV programming limits:

1. Choose *Parental Controls* from the Main menu. If *Parental Controls* have previously been locked, you must enter your password.
2. Highlight and select *USA V-Chip*.
3. Highlight and select *V-Chip TV Rating*.
4. Once you get to the *V-Chip TV Rating* screen, use the arrow buttons and OK on your remote to change the status of a TV program rating or content theme from *Viewable* to *Blocked*.

Proceed to the next sections for more details about how to change the status of TV program limits.

# Using the TV's Features

## USA V-Chip Rating Limit Screen

The following is an example of where items are located within the *V-Chip TV Rating* screen below the *USA V-Chip* menu.

**Rating Field**  
Lets you select from a list of age-based ratings you can block or view.

**Rating Status Field**  
Lets you select whether the status of the age-based rating limit to the left is Viewable or Blocked.

**Rating Settings Area**  
Lets you see the current block/view state of age-based ratings and associated content. The Viewable (V) settings are coded in green, and the Blocked (B) settings are coded in red.

**Content Themes**  
Lists the content themes you can block or view.

**Content Status Fields**  
Lets you select which content themes to view for the selected rating, and whether the status of the content theme is currently Viewable (V) or Blocked (B).

The screenshot shows a menu with options: 0 Go Back, 1 V-Chip TV Rating, and 2 V-Chip Movie Rating. The main screen displays a table of ratings and their content themes. The 'Rating' column lists TV-MA, TV-14, TV-PG, TV-G, TV-Y7, and TV-Y. The 'Status' column shows Viewable (V) for TV-14 and Blocked (B) for others. The 'Rating Content' section shows checkboxes for themes D, L, S, V, and FV. A note at the bottom says: 'Press OK to set the age-based TV rating limit and content theme limit.'

Age-Based Rating	USA Description and Content Themes for Age-Based Ratings
<b>TV-MA</b>	<b>Mature Audience Only.</b> Specifically designed to be viewed by adults and may be unsuitable for children under 17. It contains one or more of the following content themes: crude indecent language (L), explicit sexual activity (S), or graphic violence (V).
<b>TV-14</b>	<b>Parents Strongly Cautioned.</b> Contains some material that many parents would find unsuitable for children under 14. Parents are strongly urged to exercise greater care in monitoring this program and are cautioned against letting children under the age of 14 watch unattended. This program contains one or more of the following content themes: intensely suggestive dialogue (D), strong coarse language (L), intense sexual situations (S), or intense violence (V).
<b>TV-PG</b>	<b>Parental Guidance Suggested.</b> Contains material that parents may find unsuitable for younger children. Many parents may want to watch it with their younger children. The program contains one or more of the following content themes: some suggestive dialogue (D), infrequent coarse language (L), some sexual situations (S), or moderate violence (V).
<b>TV-G</b>	<b>General Audience.</b> Most parents would find this program suitable for all ages. It contains little or no sexual dialogue (D) or situations (S), no strong language (L), and little or no violence (V).
<b>TV-Y7</b>	<b>Directed to Children 7 years and older.</b> Designed for children ages 7 and above. It may be more appropriate for children who have acquired the developmental skills needed to distinguish between make-believe and reality. Themes and elements in this program may include mild fantasy violence (FV) or comedic violence, or may frighten children under the age of 7.
<b>TV-Y</b>	<b>All Children.</b> Themes and elements in this program are designed for a young audience, including children from ages 2-6. It is not expected to frighten younger children.

## Blocking Age-Based Ratings

You can automatically block all program ratings above a specified age-based rating level. For example, if you only want your child to watch programs that have a TV-G rating and lower (in other words, you want the child to watch TV-G, TV-Y7, and TV-Y), then you need to block out higher ratings.

To block programs with higher ratings:

1. First, determine the lowest level rating you don't want the child to watch (see chart of age-based ratings on previous page).
2. Highlight the lowest rating you do not want the child to watch. In the example discussed above, you would highlight TV-PG, since the highest rating you want the child to watch is TV-G.
3. Press the OK button to toggle between *Viewable* and *Blocked*. The status for the rating listed to the right and all higher ratings automatically change to *Blocked* (and *B*).
4. Select *Lock TV* from the *Parental Controls* menu. Enter a password and re-enter password a second time to confirm the password.

Hierarchy of Age-Based Ratings	
TV-MA	<i>Mature Audience Only</i>
TV-14	<i>Parents Strongly Cautioned</i>
TV-PG	<i>Parental Guidance Suggested</i>
TV-G	<i>General Audience</i>
TV-Y7	<i>Directed to Children 7 years and older</i>
TV-Y	<i>All Children</i>

## Viewing Age-Based Ratings

After you block age-based ratings, you have the option of changing some of the ratings back to *Viewable* (*V*).

1. Determine which blocked rating you want to view.
2. Use the up and down arrow buttons to highlight the rating with a status of *Blocked*.
3. Press the OK button to select *Viewable*.

**Notes:** *The content status fields corresponding to the unblocked rating become Viewable as well. They and the age-based rating status are the only fields that automatically change back to Viewable when you complete this process.*

*You must remember to lock the TV for rating limits to take effect.*

## Blocking Specific Content Themes

You can block programs based on their content. When you block a content theme for a particular rating, you automatically block that content theme for higher rated programs as well.

For example, if you do not want your child to watch programs that have adult language (L) rated TV-PG or higher, then you could block out all programming TV-PG and above containing adult language.

To block program content:

1. Determine the lowest level of content you don't want the child to watch.
2. Use the up and down arrow buttons on the remote to highlight the age-based ratings that correspond with the lowest content you do not want the child to watch. (In the example above, you would highlight TV-PG.)
3. Press the OK button to change content status from (*V*) *Viewable* to (*B*) *Blocked*. All higher ratings' content themes change to *Blocked*.

**Notes:** *Broadcasters are not required to provide content themes or age-based ratings.*

*You must remember to lock the TV for rating limits to take effect.*

# Using the TV's Features

## Viewing Specific Content Themes

If you block specific content themes, you have the option of going back and changing some of the content themes back to *(V) Viewable*:

Content Themes	
D	Sexually explicit dialogue
L	Adult language
S	Sexual situations
V	Violence
FV	Fantasy Violence

1. Determine the content themes you want to change to *(V) Viewable*.
2. Use the up and down arrow buttons to highlight the age-based rating whose content theme you want to change to *Viewable*.
3. Press the OK button to change its status back to *V*. Your child would then be able to watch programs with TV-14 adult language content, but not programs with TV-PG or TV-MA language content.

**Note:** Only the content theme status corresponding to TV-14 (*L*) language changes to *(V) View*. Higher rated content themes, such as that for TV-MA language, do not change.

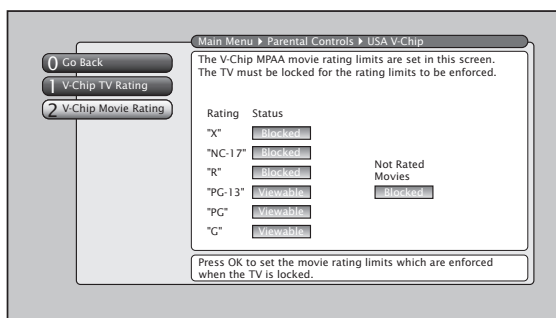

## V-Chip Movie Rating Limit

You set movie (MPAA) rating limits by blocking movies rated above a specified rating. How to block and view movie ratings is explained in the next two sections.

To access the *V-Chip Movie Rating* menu:

1. Press MENU on the remote control (the *Main Menu* appears).
2. Select *Parental Controls*.
3. Select *USA V-Chip*.
4. Select *V-Chip Movie Rating*.

## Blocking Movie Ratings

If you only want your child to watch movies that have a PG rating and lower (in other words, movies rated PG and G), then you could automatically block out all other movies with higher ratings.

To block movies:

1. Highlight the rating that is the lowest rating you don't want the child to watch. (In the example above, you would highlight the rating status button corresponding to PG-13, since the highest rating you want the child to watch is PG.)
2. Press the OK button to change the button from *Viewable* to *Blocked*. All higher ratings automatically change to *Blocked*.
3. If the TV is not locked, you must lock it so the movie rating limits will take effect.

**Note:** Some movies may be given a *Not Rated (NR)* rating. After blocking movie ratings, you must set *NR* to *Viewable* separately to view *NR* movies.

## Viewing Movie Ratings

After you block movie ratings, you have the option of changing some of the rating status buttons back to *Viewable*:

1. Highlight the rating you want to view.
2. Press the OK button to change the button from *Blocked* to *Viewable*.

For example, if movies with a rating of PG-13 and higher are blocked, you can change the rating status corresponding with NC-17. Your child would then be able to watch all movies with a G, PG, and NC-17 Rating.

3. Exit the screen, and be sure the TV is locked.

## Canada V-Chip

Canadian TV V-Chip supports two different Canadian rating systems: English and French.

Age-Based Rating	Canada V-Chip English Rating System
<b>18+</b>	<b>Adults.</b> Programming intended for adults 18 and older. It may contain elements of violence, language, and sexual content which could make it unsuitable for viewers under 18. Violence guidelines: may contain violence integral to the development of the plot, character or theme, intended for adult audiences. Other content guidelines: may contain graphic language and explicit portrayals of nudity and/or sex.
<b>14+</b>	<b>Viewers 14 and over.</b> Programming contains themes or content which may not be suitable for viewers under the age of 14. Parents are strongly cautioned to exercise discretion in permitting viewing by pre-teens and early teens. Violence guidelines: may contain intense scenes of violence. Could deal with mature themes and societal issues in a realistic fashion. Other content guidelines: may contain scenes of nudity and/or sexual activity. There could be frequent use of profanity.
<b>PG</b>	<b>Parental Guidance.</b> Programming intended for a general audience but which may not be suitable for younger children (under the age of 8). Parents may consider some content inappropriate for unsupervised viewing by children aged 8-13. Violence guidelines: depictions of conflict and/or aggression will be limited and moderate; may include physical, fantasy, or supernatural violence. Other content guidelines: may contain infrequent mild profanity, or mildly suggestive language. Could also contain brief scenes of nudity.
<b>G</b>	<b>General Audience.</b> Programming considered acceptable for all ages groups. While not designed specifically for children, it is understood younger viewers may be part of the audience. Violence guidelines: will contain very little violence, either physical or verbal or emotional. Will be sensitive to themes which could frighten a younger child, will not depict realistic scenes of violence which minimize or gloss over the effects of violent acts. Other content guidelines: there may be some inoffensive slang, no profanity and no nudity.
<b>C8+</b>	<b>Children 8 and Older.</b> Programming generally considered acceptable for children 8 years and over to watch on their own. Violence guidelines: violence will not be portrayed as the preferred, acceptable, or only way to resolve conflict or encourage children to imitate dangerous acts which they may see on television. Any realistic depictions of violence will be infrequent, discreet, of low intensity and will show the consequences of the acts. Other content guidelines: there will be no profanity, nudity or sexual content.
<b>C</b>	<b>C (Children)</b> Programming intended for children under age 8. Violence guidelines: careful attention is paid to themes which could threaten children's sense of security and well being. There will be no realistic scenes of violence. Depictions of aggressive behavior will be infrequent and limited to portrayals that are clearly imaginary, comedic or unrealistic in nature. Other content guidelines: there will be no offensive language, nudity or sexual content.

# Using the TV's Features

Age-Based Rating	Canada V-Chip French Rating System
<b>18+</b>	<b>Adults.</b> Programming is for adults only. This program contains sustained violence or extremely violent scenes.
<b>16+</b>	<b>Viewers 16 and over.</b> Programming is not suitable for those under age 16. This program contains frequent scenes of violence or intensely violent scenes.
<b>13+</b>	<b>13+ (Viewers 13 and over)</b> Programming may not be suitable for children under the age of 13. This program either contains several violent scenes or one or more scenes that are violent enough to affect them. Viewing in the company of an adult is therefore strongly recommended for children under the age of 13.
<b>8+</b>	<b>8+ (Viewers 8 and over)</b> Not recommended for young children. This program is suitable for most audiences, but it contains mild or occasional violence that could upset young children. Viewing in the company of an adult is therefore recommended for young children (under the age of 8) who do not distinguish between reality and imagination.
<b>G</b>	<b>G (General Audience)</b> This program is suitable for audiences of all ages. It contains no violence, or any violence that it does contain is either minimal or is presented in a humorous manner, as a caricature, or in an unrealistic way.

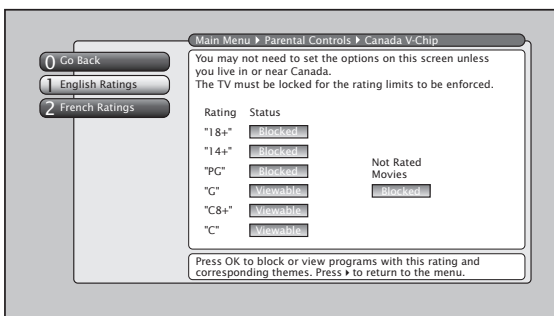

## Canada V-Chip

The *English* or *French Canada V-Chip TV Rating* lets you decide which TV programs can and cannot be viewed. To set TV programming limits:

1. Choose *Parental Controls* from the Main menu. If *Parental Controls (TV)* have previously been locked, you must enter your password.
2. Highlight *Canada V-Chip* and select either Canada's *English Ratings* or *French Ratings*.
3. Once you get to the *English* or *French Ratings* screen, use the arrow buttons and OK on your remote to change the status of a TV program rating or content theme from *Viewable* to *Blocked*.

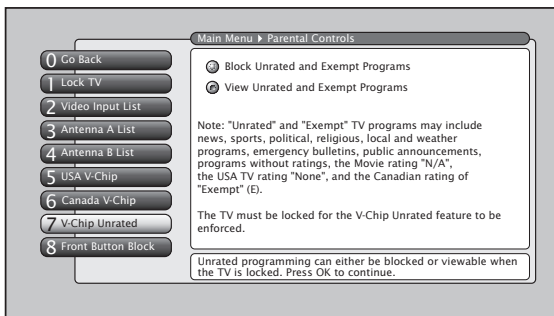

## V-Chip Unrated Program Block

Selecting this option lets you decide if programs that the V-Chip recognizes as "Unrated" (USA) and "Exempt" (Canada) can be viewed. Note that "Unrated" and "Exempt" TV programs may include news, sports, political, religious, local and weather programs, emergency bulletins, public announcements, and programs without ratings, the movie rating "N/A," and the TV rating "None" and the Canadian rating of "Exempt."

**Block Unrated and Exempt Programs** All unrated and exempt programs are available.

**View Unrated and Exempt Programs** All unrated and exempt programs are not available.

**Note:** You must remember to lock the TV for rating limits to take effect.



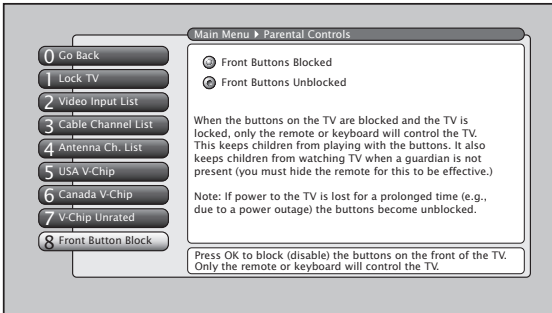

## Front Button Block

Selecting this option lets you block (disable) or unblock (enable) the TV's front buttons. The remote still tunes to any channel. *Front Panel Block* can:

- Keep children from watching TV when the parent is not present.
- Keep young children from playing with the buttons on the TV.

(When using this as a *Parental Control* method, you should remove access to any remote that is capable of operating the television.)

Don't forget to lock the TV after you select *Blocked*. If you do not, the front panel block will not take effect.

**Note:** If power to the TV is lost for an extended period, the buttons become unblocked. Blocking the front buttons does not disable the front input jacks.

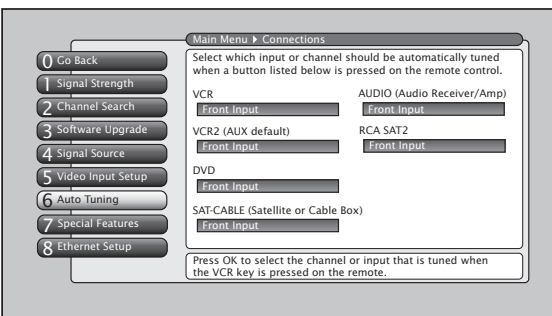

## Auto Tuning Feature

The way you set up the *Auto Tuning* feature in the TV's menu corresponds to the component buttons on the remote and the way you have each component connected to your TV. When you set auto tuning, you're telling the TV what channel or input to tune to when you press the DVD or AUX button on the remote control. This is especially useful for going directly to an input like HDMI/DVI.

**Notes:** The AUX button by default is set up for an RCA VCR. If you need to reprogram the AUX button, use the 2001 code. Then use the VCR2 option in the auto tuning menu to set auto tuning.

The RCA SAT2 option doesn't have a function for your remote.

With the Auto Tuning feature, you can set up the TV to tune to the channel you want to watch by pressing that component's button. Auto Tuning for the TV button cannot be set.

1. Press MENU (the *MAIN MENU* appears).
2. Highlight *Connections* and press OK.
3. Highlight *Auto Tuning* and press OK.
4. Highlight the component button field and continually press OK to scroll through the selection of inputs.

The choices and a brief explanation follow:

**Not Connected** Choose this if you don't have this particular component connected to the TV, or if you don't want the TV to automatically tune to the correct channel when you press one of the component buttons on the remote.

**Channel 2, 3 or 4 Cable Input** Component is connected to the *CABLE INPUT* jack on the back of the TV, and you want the TV to tune to channel 2, 3, or 4 when you press the corresponding button on the remote. Reminder: make sure the component's Channel 2/3 or 3/4 switch is set to match the channel you choose in *Auto Tuning*.

**Channel 2, 3 or 4 Antenna Input** Component is connected to the *ANTENNA INPUT* jack on the back of the TV, and you want the TV to tune to channel 2, 3, or 4 when you press the corresponding button on the remote. Reminder: make sure the component's Channel 2/3 or 3/4 switch is set to match the channel you choose in *Auto Tuning*.

# Using the TV's Features

**Input 1** Component is connected to the Input 1 Video (V) or S-VIDEO jack on the back of the TV and you want the TV to tune to the Video Input Channel when you press the corresponding button.

**Input 2** Compatible video source, such as a DVD player or satellite receiver, is connected to the Input 2 COMPONENT/COMPOSITE INPUT jacks (Y/Video, Pb, Pr) on the back of the TV and you want the TV to tune to the composite/component video input when you press the corresponding button.

**Front Input** Component is connected to the S-VIDEO IN or VIDEO IN jack on the front of the TV and you want the TV to tune to the front Video Input Channel when you press the corresponding button.

**HDMI/DVI** Component is connected to the HDMI/DVI jack on the back of the TV and you want the TV to tune to this input when you press the corresponding button.

## PIP (Picture-in-Picture) Operation

The PIP (Picture-In-Picture) feature lets you display a second, smaller analog (NTSC format) picture on top of the main analog picture. You will only be able to use the PIP window and main picture with analog channels and inputs; PIP doesn't support digital signals. The main and PIP channels must be from different tuners; you must have the main picture from CABLE INPUT and the PIP picture from ANTENNA INPUT, or vice-versa.

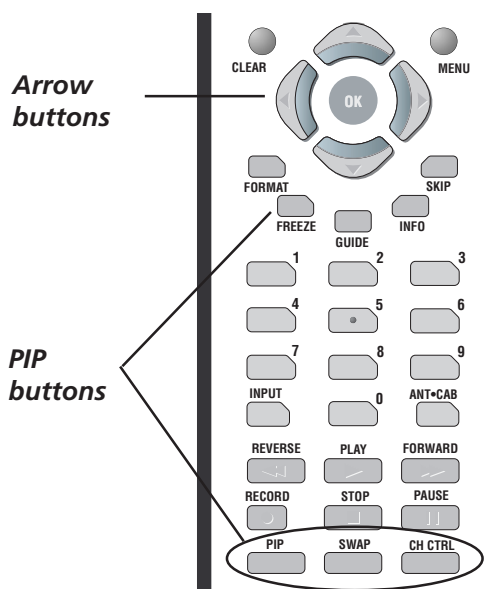

### Tip

If you want to go directly to an input or channel in PIP (or main), set up auto tuning and press the component button (AUX or DVD).

### PIP Buttons

There are certain remote buttons that control the way the PIP window works:

**PIP** Brings up the PIP window. Press PIP again to remove the window.

**Arrows** Let you move the PIP window to different areas of the screen.

**SWAP** Switches the video from the PIP window to the main picture.

**FREEZE** Freezes entire screen, including the main picture and PIP window, if PIP is displayed.

**CH CTRL** (Channel Control) Lets you switch channel control between the PIP window and the main picture. To determine whether you are controlling the PIP or the main picture, look at the channel banner as you change channels or press INFO button. The triangular indicator (>) beside the channel number lets you know which picture you're controlling with channel up/down, number buttons, etc.

### Using the PIP Feature

The PIP feature is only available for analog (NTSC) channels; PIP won't work when tuned to a digital (ATSC) channel. Use the channel banner to determine whether a channel is digital or analog. A digital (ATSC) channel has a dash and second number after it (e.g., 21-2); an analog channel doesn't (e.g., Ch 21). While you may use PIP in different ways, this basic PIP scenario should get you started. When watching an analog channel, follow these steps.

1. Press the PIP button on the remote control. The PIP window appears on the screen and *Channel Control* is automatically set to the PIP window.



2. Use the channel up and down, INPUT, ANT•CAB, or number buttons, or component buttons that have been auto tuned, to change the PIP channel.
3. To change the program in the main picture window, press CH CTRL. Then use any of the above mentioned buttons. To go back and forth between controlling the PIP window and the main picture, press the CH CTRL button.

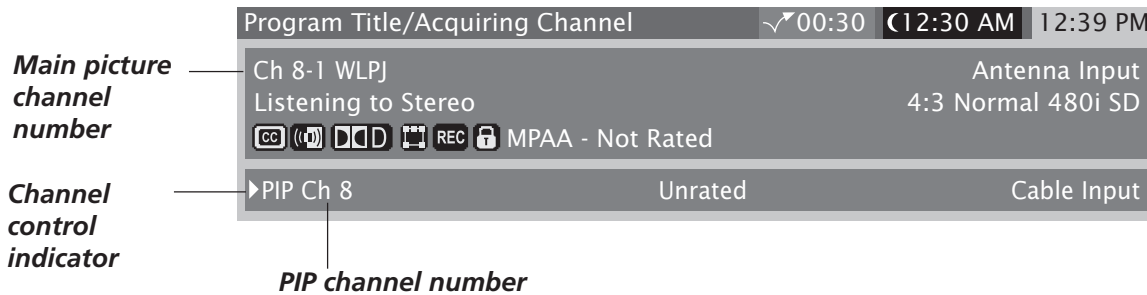

## PIP Problems?

- If you are channel surfing in the main window and PIP disappears, you may have tuned to a digital channel. To view PIP and the main picture, make sure that both the main and PIP channels are analog inputs, or signals. Continue changing the channel until you find an analog (NTSC format) channel. The PIP window will reappear.

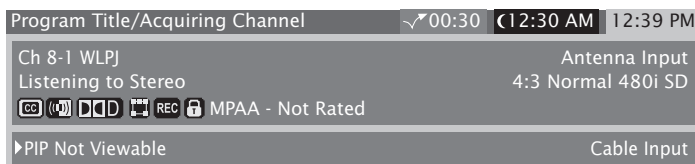

*The message "PIP Not Viewable" in the channel banner lets you know that PIP is not available on this channel and you should tune to another channel.*

- If you press PIP and the PIP window is gray, you may have activated the Parental Control feature and the program exceeds the rating limits you set. For information on removing limits, see the section "Parental Controls."
- Closed captioning is not viewable in the PIP window.
- PIP channel skips all digital (ATSC) TV channels and tunes to analog channels.
- PIP can only be displayed in analog signals from CABLE, ANTENNA, composite, S-VIDEO and component (Y, Pb, Pr) inputs in 480i format.

## Emergency Alert System (EAS)

The EAS works only if you have a digital cable card connected to the CableCARD slot on the back of the TV. Your cable company informs you of emergency alert information related to your state or local-level emergencies, such as Flash Flood Warnings, Severe Thunderstorm Warnings, and Tornado Watches. When your TV receives a state or local-level emergency, a message is displayed that lasts approximately 2 minutes, but can be repeated if necessary. During this time, you can't clear the information being displayed. In the rare event that there is a national-level emergency, your TV would tune to a channel broadcasting the emergency information.

*This page intentionally left blank*

# Using the TV's Menu System

## Chapter Overview:

- Menus, On-Screen Help, and Control Panels
- Picture Quality Menu
- Audio Menu
- Connections Menu
- Preferences Menu

Changing Entertainment. Again.



# Using the TV's Menu System

## Menus, On-screen Help, and Control Panels

This section highlights your TV's on-screen menu system. The menu system has several types of screens. An overview follows.

**Note:** The *Parental Controls* menu item is discussed in the *Features* chapter while *Assisted Setup* is discussed in the *Connections and Setup* Chapter.

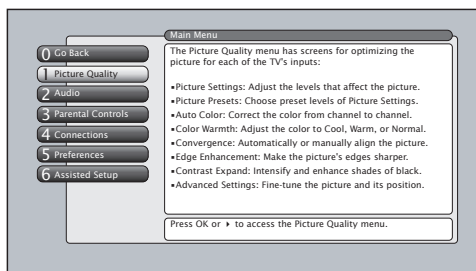

### Tips

A shortcut method to access a menu item is to press the number button on the remote that matches the number next to the on-screen menu. For example, in the *Main Menu*, press 2 to go straight to the *Audio* menu.

Feel free to explore the menu system. If you're ever unsure where you are in the menu system, look at the menu path at the top (for example, *Main Menu*, *Picture Quality*) or if you're just tired of exploring, press *CLEAR* to remove the menus from the screen and start over again.

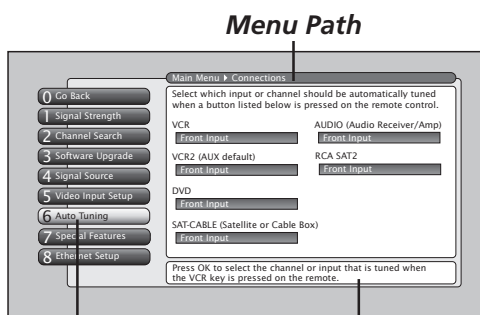

Highlighted  
Menu  
Selection

Help Text

## Navigating the Menu System

The first menu you see when you press the MENU button on the remote is called the *Main Menu*. To access the *Main Menu*:

1. Press the MENU button (the *Main Menu* appears).
2. Use the arrow buttons (left, right, up, down) to move through the menu and highlight different options.
3. Press the OK button to select a highlighted item.

**Note:** Press the number button on the remote that matches the number next to the on-screen menu to select the option.

To exit the *Main Menu*:

- Press CLEAR. The on-screen displays are cleared from the screen and you return to TV viewing.
- Press MENU.
- Press 0 (Go Back) or GO BACK on the remote.

## On-Screen Help

Information appears on most screens to assist you in understanding your menu selection. To the right of the highlighted menu item is a display area that might provide text for the item selected along with any submenu items. In addition, a menu path appears at the top of the screen to let you know where you are in the menu system. At the bottom of the screen are two lines of help text that explain the currently highlighted item.

## Controls

Controls let you adjust the default settings of your TV. You can choose a setting, enter a number, or adjust a level such as tint or brightness. There are four types of controls:

- Sliders
- Choice lists (check boxes, radio buttons)
- Alpha/numeric entries
- Menu (action, choice fields)

# Using the TV's Menu System

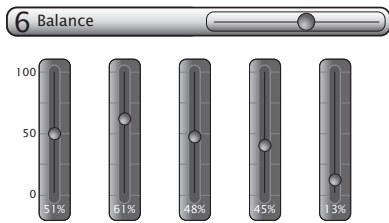

## Sliders

Sliders are used to select a specific point of a control that has continuous levels. To make adjustments:

1. Highlight the slider for the feature you want to adjust.
2. Press the up or down arrow button to adjust the indicator on a vertical slider. Press the left or right arrow to adjust the indicator on a horizontal slider.



Check Boxes



Radio Buttons

## Choice Lists

Check boxes and radio buttons are used to select options from a list. Check boxes let you select one or more options. A radio button lets you select only one option.

1. Use the arrow buttons to move left/right/up/down.
2. Press OK to select a radio button; press OK to select or de-select a check box.

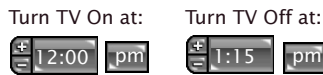

## Numeric Entries

Numeric entry fields are used to enter numbers, passwords, and time values. The number buttons on the remote and the arrow, channel up/down, volume up/down, MENU/OK buttons on the front panel can be used to enter the information.

1. Use the left/right arrow button to highlight the field.
2. To enter time values, such as the Wake-Up Timer, highlight the + or - field and press OK to change the time, or simply use the number buttons. To enter passwords, you must use the number buttons.

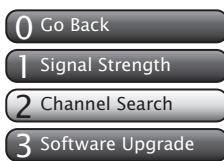

## On-screen Menu Items

The on-screen menu items are used to access the information and/or change the settings of the specific item highlighted. Highlight the item with the up and down arrow buttons. Then press OK or right arrow button to access the item's information. To make a selection in one step, press the number button corresponding to the item.



## Action Buttons

An on-screen button that performs the action labelled on the button. Press the right arrow button to highlight and press OK to select.

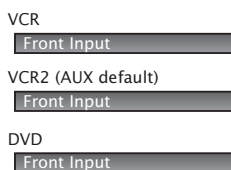

## Choice Fields

A choice field cycles through at least two or more choices. Press OK to select the next entry within the choice field. Moving the highlight to a different choice field saves the selection previously made.

# Using the TV's Menu System

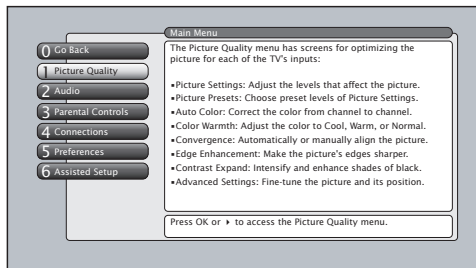

## Picture Quality Menu

The *Picture Quality* menu contains menus to configure video settings: *Picture Settings*, *Picture Presets*, *Auto Color*, *Color Warmth*, *Convergence*, *Edge Enhancement*, *Contrast Expand*, and *Advanced Settings*. Each one is described below.

**Note:** When changing an item in the *Picture Quality* menu, the graphics become transparent so you can see how your adjustments affect the picture.

To access the *Picture Quality* menu:

1. Press MENU on the remote control (the *Main Menu* appears).
2. Press 1. The *Picture Quality* options appear. Each is described below.

**Note:** When making *Picture Quality* changes, inputs are all adjusted independent of each other. Digital cable and antenna channels are adjusted independent of analog cable and antenna channels.

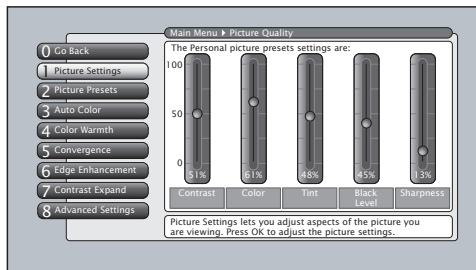

## Picture Settings

The *Picture Settings* menu displays five slider controls for adjusting the way the picture looks. Your options under the *Picture Settings* menu are:

**Contrast** Difference between the light and dark areas of the picture.

**Color** The richness of the color.

**Tint** The balance between the red and green levels.

**Black Level** The brightness of the picture.

**Sharpness** The crispness of the edges in the picture.

To create picture settings for the video inputs:

1. Press the INPUT button while in the *Picture Settings* menu until the correct Video Input Channel appears in the upper right corner.
2. Press the right and left arrow buttons on the remote control to select the slider.
3. Press the up and down arrow buttons to operate the slider.

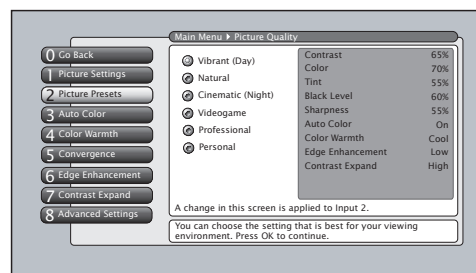

## Picture Presets

*Picture Presets* displays a choice list that lets you select one of the six preset picture settings: *Vibrant (Day)*, *Natural*, *Cinematic (Night)*, *Videogame*, *Professional*, and *Personal*.

Choose your setting based on the degree of lighting in your room. After you select a preset, the settings listed to the right are adjusted automatically.

If you choose *Personal*, you can customize each *Picture Quality* setting to your desired level, and a message appears to asking if you want to save those settings. After you've saved your personal settings, you can go back into the menu and select a different picture preset. For example, if you normally use *Personal* but want to watch a show in *Vibrant (Day)* lighting, choose *Vibrant (Day)*, watch the show, and then afterwards return to your customized settings by choosing *Personal*.

### Tip

To create a temporary personal setting, make your changes and when the message appears asking if you want to save the setting, select No. The preset is saved until you change the channel or input.

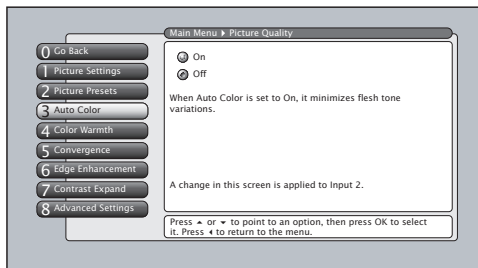

## Auto Color

*Auto Color* minimizes the flesh tone variations of the TV picture. Choose *On* or *Off*, depending on your preference.

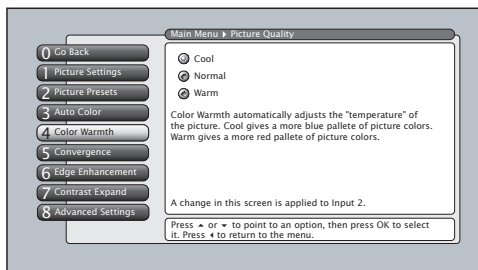

## Color Warmth

*Color Warmth* automatically adjusts the color temperature of the picture. The feature lets you set one of three automatic color adjustments:

**Cool** More blue.

**Normal** Standard picture color.

**Warm** More red.

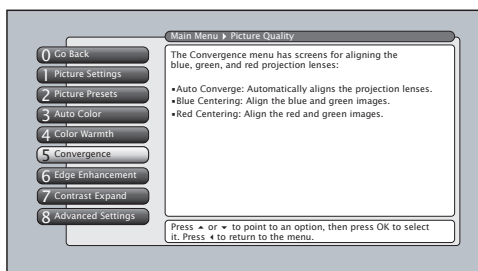

## Convergence

The *Convergence* feature lets you adjust the TV's three tubes. When the TV tubes' images are precisely aligned, they create the color images you see on the screen. Over time, the picture can drift out of alignment (this is normal). If your picture seems fuzzy or has a yellow tint, using *Convergence* could correct this misalignment. Only one convergence is needed for all inputs, regardless of the signal format.

**Note:** Make sure the TV has been on for at least 30 minutes (TV needs to warm up for best results) before starting *Auto Converge* or *Red/Blue Centering*.

When you select the *Convergence* feature, a submenu appears with three options:

**Auto Converge** Automatically aligns the projection lenses to self-correct color images. You'll see flashing squares of color dance across the screen (this is normal).

**Note:** After performing *auto convergence*, use the *Blue Centering* and *Red Centering* menus to fine tune convergence in the center of the screen, if necessary.

**Blue Centering** Aligns the blue and green images to fine-tune the picture.

**Red Centering** Aligns the red and green images to fine-tune the picture.

**Note:** The ability to change channels is disabled when adjusting the convergence options. The TV must be tuned to a usable signal to converge the picture.

# Using the TV's Menu System

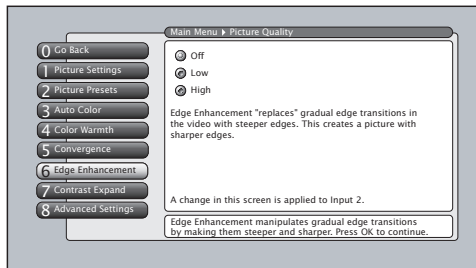

## Edge Enhancement

*Edge Enhancement* makes the edges of the video steeper, sharper, and crisper. There are three options for the edge enhancement: *Off*, *Low*, or *High*. If artifacts appear in the video, change the setting to *Low* or *Off*.

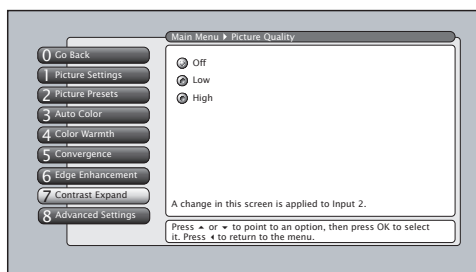

## Contrast Expand

*Contrast Expand* makes the picture appear brighter by deepening the black parts of the picture. This also helps to maintain a more consistent black level from one scene to the next. The options are *Off*, *Low*, and *High*.

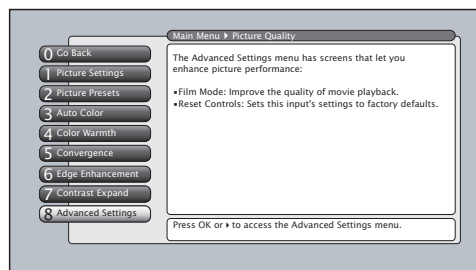

## Advanced Settings

The Advanced Settings option lets you enhance picture performance and adjust picture position. When you select *Advanced Settings*, a submenu appears with options:

**Film Mode** Automatically detects video sources that were originally recorded on film and converted to a different format. Film mode modifies the converted signal so it looks as close as possible to the original, a process called reverse 3:2 pulldown. Film mode is applied to all inputs. Options are:

- **Advanced** The default and recommended setting.
- **On** Used in circumstances when the TV is to be used solely with film-based sources.
- **Off** Use this setting if you think the reverse 3:2 pulldown is causing distortions in your picture.

**Reset Controls** Resets all Picture Quality controls to their original factory settings (except *Personal Picture Preset*) for the currently tuned input (see on-screen text). To reset the settings, you must:

1. Tune to the input you would like to reset.
2. Press MENU to access the *Main Menu*.
3. From the *Advanced Settings* menu, select *Reset Controls*, and then select *Reset* to set reset the settings for the currently tuned input.



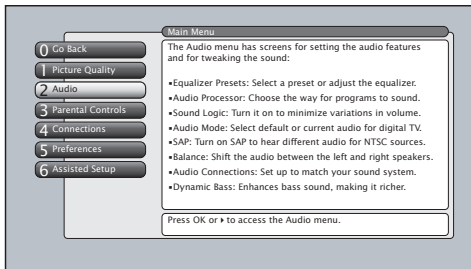

## Audio Menu

The *Audio* menu lets you adjust audio output. To access the *Audio* menu, press MENU on the remote, and then select *Audio* from the main menu. The following audio items can be adjusted: *Equalizer Presets*, *Audio Processor*, *Sound Logic*, *Audio Mode*, *SAP*, *Balance*, and *Audio Connections*.

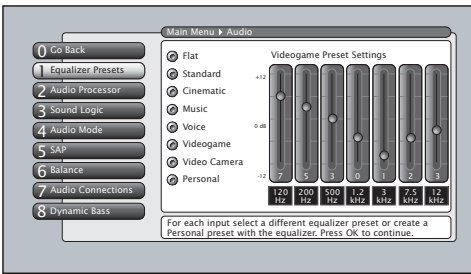

## Equalizer Presets

You can select one of the seven-band Equalizer Presets or create your own personal preset. The seven-band graphic equalizer lets you adjust the audio frequency settings.

**Note:** *Equalizer Presets are stored for each input. All other audio feature settings are stored globally across all inputs and not per input.*

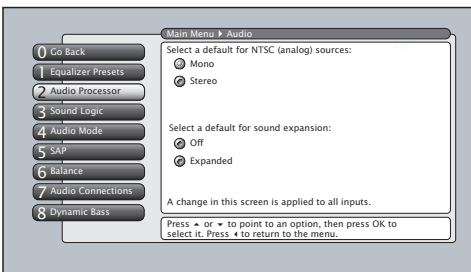

## Audio Processor

The Audio Processor displays a choice list of available audio settings, which control the way the sound comes through your speakers. The selected setting affects all inputs and tuners.

To create the settings:

1. Press the MENU button to access the main menu.
2. Select *Audio*, and then *Audio Processor*. The following options appear:

**Mono** Plays the sound in monophonic audio only. This should only be used when the stereo signal is weak. The channel banner displays the word *Mono* when you have selected Mono.

**Stereo** Splits the incoming stereo audio signal into left and right front channels. Most TV programs and recorded materials have stereo audio. The channel banner displays the word *Stereo* when you have selected Stereo.

The following options are available only if sound is set to Stereo:

**Off** No processing is applied to the audio.

**Expanded** Adds greater depth and stereo separation to stereo audio signals.

# Using the TV's Menu System

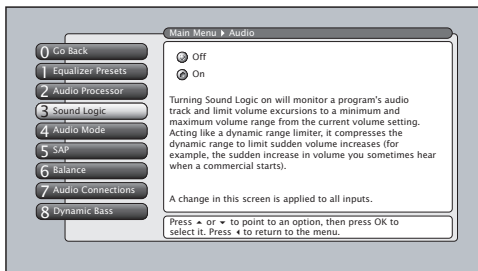

## Sound Logic

Acting like a dynamic range limiter; it compresses the dynamic range to limit suggested volume increases (for example, the sudden increase in volume you sometimes hear when a commercial starts). Choose *On* or *Off*, depending on your preference.

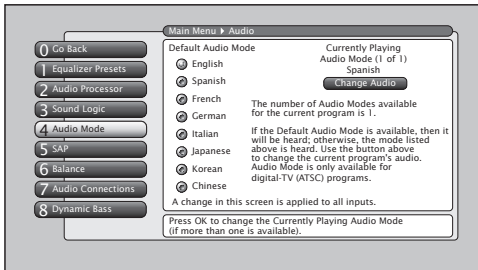

## Audio Mode

The *Audio Mode* menu lets you choose the default audio mode you want to hear for ATSC (digital TV) programs. If the Audio Mode icon (  ) in the banner lights, it means there is more than one audio mode available. The system automatically sets the audio program to the default audio mode from the menu when the channel you are viewing is a digital channel and the specified audio mode is available for that program.

In the *Audio Mode* menu, highlight the default audio mode you want by pressing the up and down arrow buttons on your remote control. Press OK to hear that language by default whenever available on a channel.

Some programs can have audio mode available that can be heard but that cannot be set as the default. To select and hear those audio modes, navigate to the “Change Audio” action button and select OK.

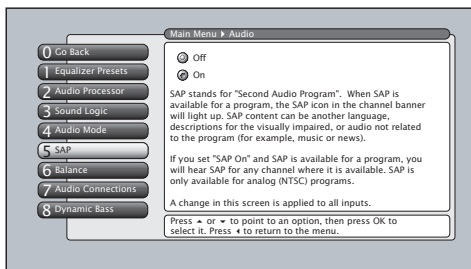

## SAP (Second Audio Program)

When turned on and available, Second Audio Program plays the analog program's audio in a second language. SAP is also used to broadcast a program's audio with descriptions of the video for the visually impaired. SAP might also contain audio which is totally unrelated to the video.

*Note: SAP is broadcast in mono and is only available for analog programs, not digital programs.*

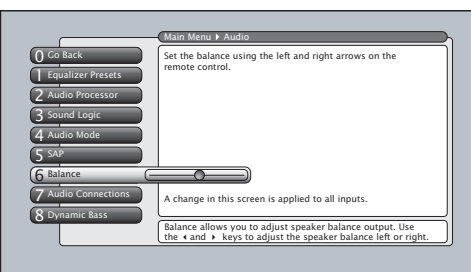

## Balance

The *Balance* setting applies to the TV's speakers and the headphone output. Balance is how much audio (loudness) gets sent to the left and right speakers.

# Using the TV's Menu System

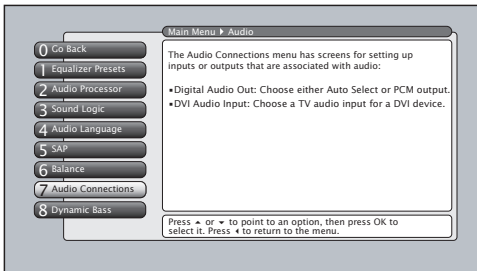

## Audio Connections

The Audio Connections option lets you set up input or outputs associated with audio. When you select the Audio Connections feature, a submenu appears with options: *Digital Audio Out* and *DVI Audio Input*.

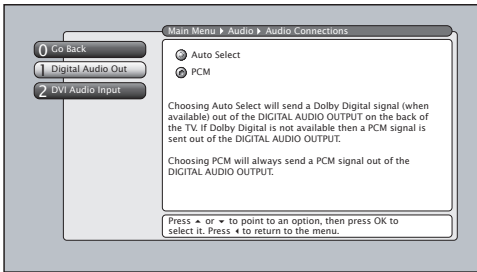

**Digital Audio Out** Allows you to receive Dolby Digital surround sound if transmitted and you've connected a six-channel receiver to the TV's DIGITAL AUDIO OUTPUT jack with a digital optical cable. Choose the correct setting in the *Digital Audio Out* menu:

- **Auto Select** Your TV automatically chooses between Dolby Digital and PCM based on the audio signal it is receiving. This is the best selection if you have a decoder with Dolby Digital and PCM that was manufactured in the last several years.
- **PCM** (Pulse Code Modulation) The TV sends all signals through the Digital Audio Output in PCM.

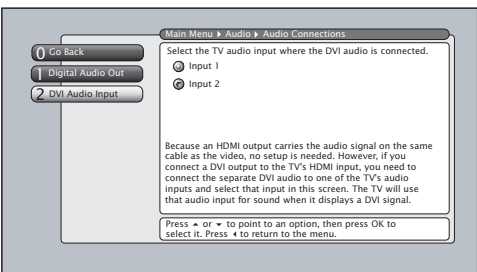

**DVI Audio Input** Allows you to select the audio input you're using if you've connected an HDMI/DVI cable adapter to the DVI input. Select from the inputs listed.

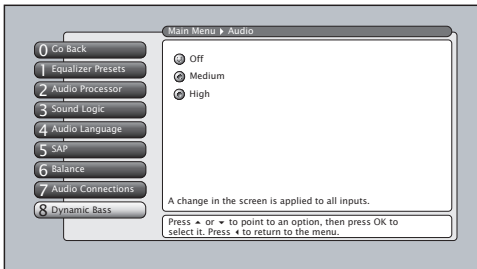

## Dynamic Bass

The Dynamic Bass option provides additional bass enhancement for the audio. Choose *Off*, *Medium*, or *High* depending on your preference.

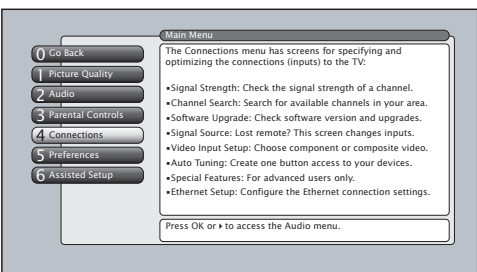

## Connections Menu

The *Connections* menu specifies various ways to adjust the inputs to your television. Items in the *Connections* menu are: *Signal Strength*, *Channel Search*, *Software Upgrade*, *Signal Source*, *Video Input Setup*, *Auto Tuning*, *Special Features*, and *Ethernet Setup*.

# Using the TV's Menu System

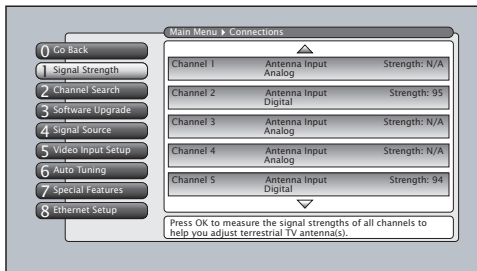

## Signal Strength

This screen lists any channel EVER added to the TV. The list shows the channel number, the station name (only when tuned, e.g. NBC), whether the channel is digital or analog, which tuner is picking up the channel, and current signal strength of digital channels.

When you move the highlight to the *Signal Strength* list, the TV attempts to tune to that channel. You can then adjust your off-air antenna for maximum signal strength (largest number) for the selected channel. The signal strength for a digital channel will be shown as “- -” until the signal is strong enough for use, then numbers will appear. Analog channels will always have the display, “N/A”, since analog signal strength is not measured.

Only primary channels appear in the list. Digital subchannels, e.g. 8-1, 8-2, do not appear.

*Note: If you have both Antenna and Cable channels, press the ANT•CAB button to view your Cable channels, or vice-versa.*

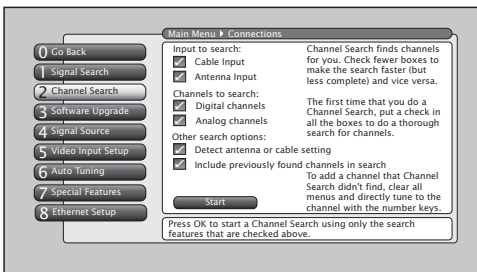

## Channel Search

Engaging in a channel search tells the TV to search for all the terrestrial TV channels available through the Antenna and Cable inputs. When the TV finds an active channel, it places it in the channel list. Inactive channels (weak stations or channels with no signal at all) aren't placed in the channel list.

To do a complete channel search, check each box that pertains to your TV. For example, if you're only receiving cable from the CABLE INPUT, highlight *Cable Input* and press OK to place a checkmark in the box. Select *Start* to begin the setup.

*Notes: Channel Search with all options selected takes some time to complete because all possible analog and digital channels are being searched.*

*If cable box or CableCARD is connected to your TV's CABLE INPUT, Channel Search won't work for it.*

### Tip

You can still add a channel that was not found by Channel Search. Clear any on-screen menus, and tune to it by using the number buttons on the remote. If the channel can be tuned, it will be added to the channel list for that tuner.

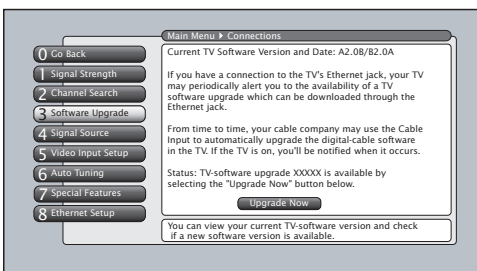

## Software Upgrade

The *Software Upgrade* screen contains current software information and indicates if a new upgrade is available. The software upgrades can be accomplished only if you have the TV connected via the Ethernet cable to the Internet with ISP subscription. Select the *Upgrade Now* button, if available, to upgrade your software.

*Note: If using a dialup service via a router connected at a dialup speed of 56K, the Software Upgrade could take several hours or more. If TV is unplugged while doing a Software Upgrade during this time, it could cause the TV to not operate properly.*

# Using the TV's Menu System

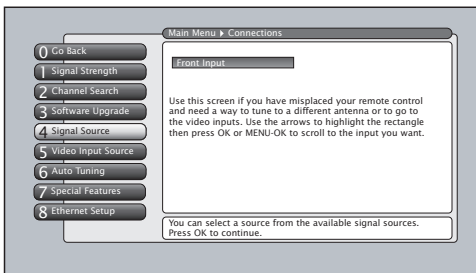

## Signal Source

The *Signal Source* menu allows you to choose the source from which you would like the signal to come: Cable Input, Antenna Input, or Video Inputs. The same can be accomplished using the component buttons if you've set up Auto Tuning on the remote or by pressing the INPUT button. But, if you misplace the remote, this feature gives you another way to tune to a signal source.

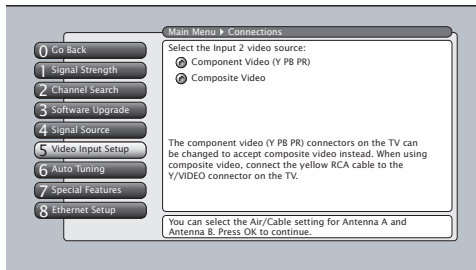

## Video Input Setup

The *Video Input Setup* screen lets you choose which type of connection you're using for the Input 2 jack on the back of the TV. If you decide to change the connection, you need to go back into the *Video Input Setup* screen and select the corresponding option.

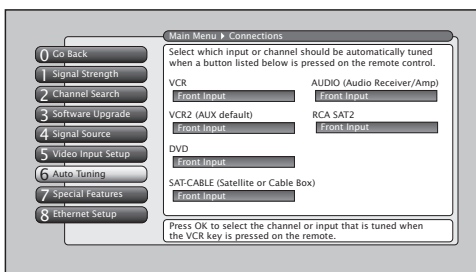

## Auto Tuning

This menu lets you specify the various components you have connected to your TV. It lets you program a component button on the remote control (AUX or DVD) so that pressing the button automatically turns on the TV and turns the TV to the correct Video Input Channel (go to Chapter 3 for detailed information).

**Notes:** The AUX button by default is set up for a second RCA VCR. If you need to reprogram the AUX button, or instead want to program the VCR button, use the 2001 code. Then use the VCR2 option in the auto tuning menu to set auto tuning.

The RCA SAT2 option doesn't have a function for your remote.

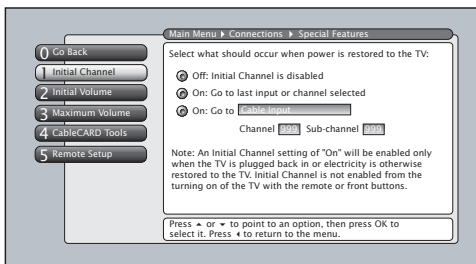

## Special Features

*Initial Channel* and *Initial Volume* are two special features that are mostly intended for commercial/retail use.

**Initial Channel** You can select the tuner and channel or input that your TV tunes to each time the TV is turned on by plugging it back in.

**Initial Volume** This feature works only if the *Initial Channel* feature is set to *On*. Select the volume level that you want when the TV is turned on.

**Maximum Volume** This feature is intended to stop the volume from being turned up too loudly. Set the volume at the loudest level you would want to hear.

# Using the TV's Menu System

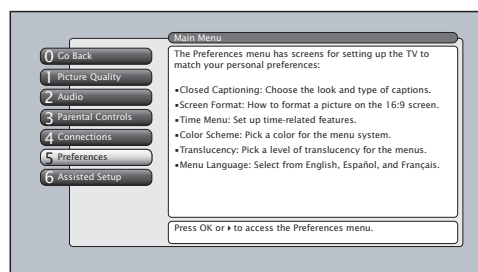
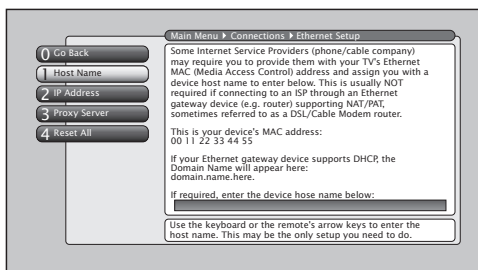
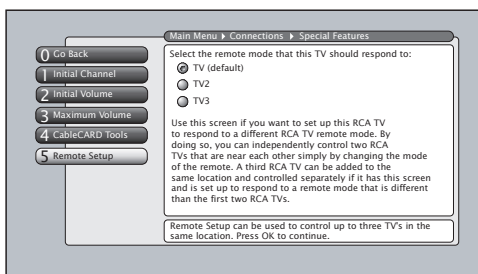
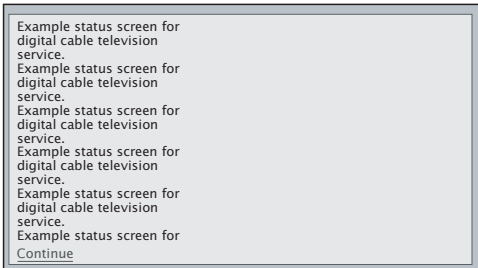
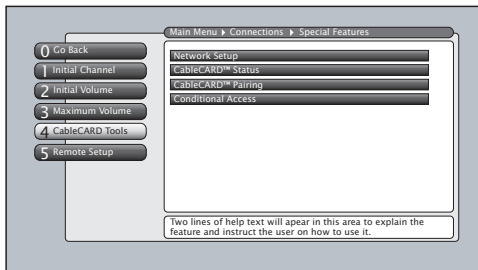

**CableCARD Tools** Displays information available for digital cable TV services when a CableCARD is inserted in the back of the TV and you have subscribed to digital cable service. Go to page 17 for more information on using your CableCARD.

The *CableCARD Tools* information might vary according to the brand of card you have inserted into your TV. The graphic to the left is an example of what you might see. Select an option to view more information.

Some *CableCARD Tools* screens might have additional information displayed on more than one page. Use the arrow buttons on the remote to highlight the blue *Continue* link at the bottom of the page, for example, as the graphic to the left shows, and simply press the OK button on the remote to read more text. If more than one link appears, use the arrow buttons to highlight the one you want. To exit the screen, press CLEAR on the remote.

**Remote Setup** Allows you to control three different RCA TVs. This is helpful if you have two or three RCA TVs near each other, and they also have this menu option, but you want to control them independent of each other. Program a second RCA TV to any component button, such as DVD or AUX, using the TV2 code 1222. Then select the TV2 option in that TV's *Remote Setup* menu. If you have a third RCA TV, program a component button using the TV3 code 1223. Then select the TV3 option in that TV's *Remote Setup* menu. Go to Chapter 2 for more information on programming your remote.

## Ethernet Setup

An Ethernet connection allows your TV to be upgraded if a software upgrade is available. Connect your TV to a router and cable modem via the ETHERNET jack. Then, go to the *Software Upgrade* menu to see if a software upgrade is available. If you have a NAT (Network Address Translation) /PAT (Port Address Translation) component with DHCP capability (router, etc.), no setup is required. The TV automatically sets itself up for Ethernet use. If you do not have a NAT/PAT router, you may need to establish some settings in conjunction with your ISP (Internet Service Provider) before you can connect to the Internet.

If an IP address isn't assigned for you, contact your network administrator to access the necessary information.

A *Reset All* selection is provided for your convenience if you move to another city and must enter new information, or enter some incorrect information.

## Preferences Menu

The *Preferences* menu allows you to change some aspects of your TV to fit your personal preferences. Features in the *Preferences* menu are: *Closed Captioning*, *Screen Format*, *Time Menu*, *Color Scheme*, *Translucency*, and *Menu Language*.



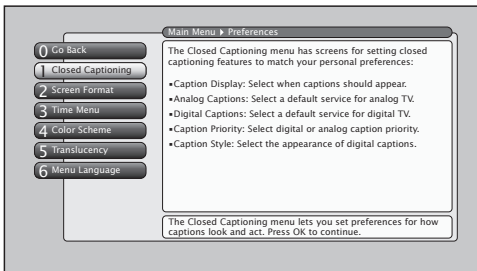

## Closed Captioning

You may set the type of captioning displayed. Captioning is not available from the PIP tuner. Choices within the *Closed Captioning* menu are: *Caption Display*, *Analog Captions*, *Digital Captions*, *Caption Priority*, and *Caption Style*.

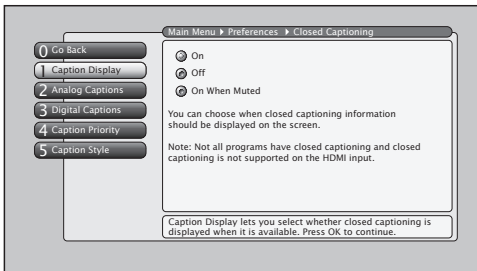

## Caption Display

The *Caption Display* menu displays a choice list that lets you choose when closed captioning information is shown on the screen. HDMI/DVI input is not supported by Closed Captioning (CC). Try the component's menu system for CC options.

**On** Captioning information is always shown when it's available on a channel or input.

**Off** No captioning information is displayed.

**On When Muted** Captioning information is only shown when available and the TV's sound is muted. (To mute the sound, press the MUTE button on the remote control and captioning information will appear on the screen, if available.)

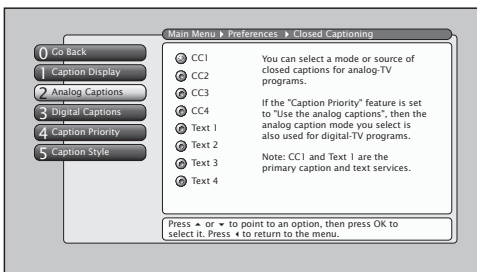

## Analog Captions

You can select a closed caption mode, which is the mode, or source, used for displaying captioning information for analog channels or digital channels, if available. The content of CC and Text are different; you can select which one you want to see on the screen.

**CC** Displays information at any position on the screen. It overlays the text on top of the picture as it is received.

**Text** Displays information at one particular position (such as the bottom third) of the screen. You cannot see the picture underneath the text.

You can choose between eight closed caption modes:

- **CC1** and **Text 1** are the primary caption and text services. The captioning or text is displayed in the same language as the program's dialog.
- **CC3** and **Text 3** serve as the preferred data channels. The captioning or text is often a secondary language translation, simplified English, or displayed at a slower rate.
- **CC2** and **CC4** and **Text 2** and **Text 4** are rarely available and broadcasters use them only in special conditions, such as when CC1 and CC3 are not available, or Text1 and Text3 are not available.

# Using the TV's Menu System

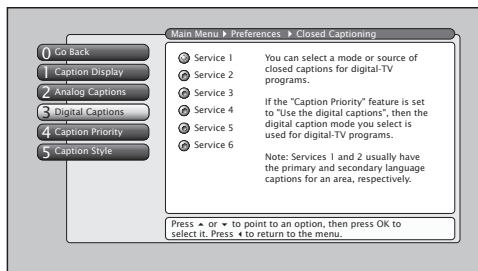

## Digital Captions

You can select a closed caption, service mode (1-6) for digital channels.

**Service 1** and **Service 2** are the primary and secondary languages, respectively.

**Service 3** and **Service 4, 5, 6** are additional caption sources that may be available. Specific label names may be displayed (e.g., Spanish) instead of a generic label (e.g., Service 1), if available.

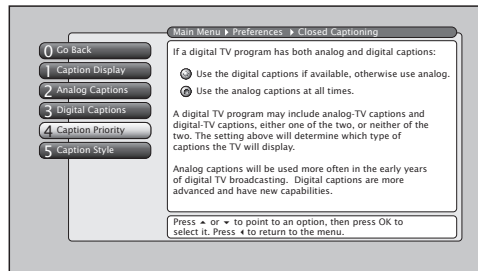

## Caption Priority

You can choose whether the TV uses digital or analog captions for digital TV programs that have both or either. The captions are displayed if turned on in *Caption Display*.

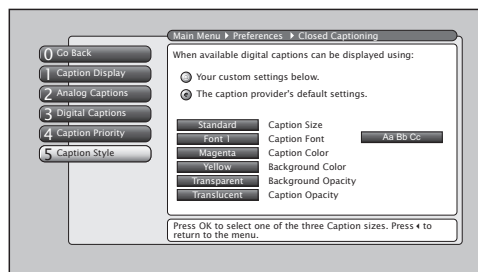

## Caption Style

Customize closed captioning for the digital captions by choosing the settings for the following options:

**Caption Size** is the font size (*Standard, Large, Small*) of the text characters.

**Caption Font** is a complete assortment of letters, numbers, punctuation marks, etc. of a given font design. You have eight fonts with varying styles of spacing from which to choose.

**Note:** A preview graphic of the caption font appears on the right of the screen.

**Caption Color** allows you to choose the font color: *White, Black, Red, Green, Blue, Yellow, Magenta, and Cyan*.

**Background Color** allows you to choose the background color: *White, Black, Red, Green, Blue, Yellow, Magenta, and Cyan*.

**Background Opacity** allows you to change the see-through background options: *Solid, Transparent, Translucent, and Flashing*.

**Caption Opacity** allows you to change the see-through caption options: *Solid, Transparent, Translucent, and Flashing*.



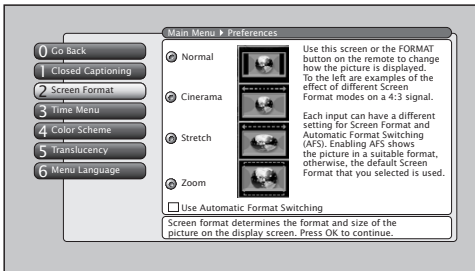

## Screen Format

The *Screen Format* feature allows you to change how the image of a 4:3 picture is displayed on your 16:9 screen. The options are *Normal*, *Cinerama*, *Zoom* or *Stretch*. If your TV receives an image with a 4:3 aspect ratio, the image can be displayed in one of four ways:

**Normal** The image of a 4:3 video signal is centered with bars on the right and left sides of the screen.

**Cinerama** The image of a 4:3 video signal is centered, expanding in the horizontal direction to fill the display with little distortion.

**Stretch** The image of a 4:3 video signal is stretched horizontally by approximately 33% while the vertical size stays the same.

**Zoom** The image of a 4:3 video signal increases by approximately 33% and the vertical size increases by approximately 33%. Edges of the image might be cropped.

Turn on *Automatic Format Switching* so that as you change channels, the TV will change formats for you.

**Notes:** There is no ability provided to change the screen format for a 16:9 video signal since it fills up the entire area of the TV's screen.

The format of some video cannot be changed even though it appears to be a 4:3 aspect-ratio picture.

The *FORMAT* button on the remote lets you change the format with a one-button press rather than navigating to the *Screen Format* menu.

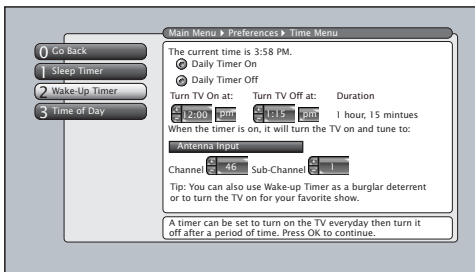

## Time Menu

The *Time* menu lets you set up time-related features. *Time* menu consists of *Sleep Timer*, *Wake-Up Timer*, and *Time of Day*.

**Sleep Timer** A one-time event that is used to set the TV to turn off at a specific time.

**Wake-Up Timer** Used to turn the TV on and off at a specific time every day of the week and tune to a specific channel.

**Time of Day** Enables you to enter the correct time manually. If you don't enter the time, it is acquired from the last tuned digital channel. Make sure you check the time acquired is correct.

**Note:** If you enter the time manually, you must remember to set your TV's time when the time changes to Daylight Saving Time. Sleep Timer and Wake-Up Timer will not function as you expect if you forget to change the TV's time.

# Using the TV's Menu System

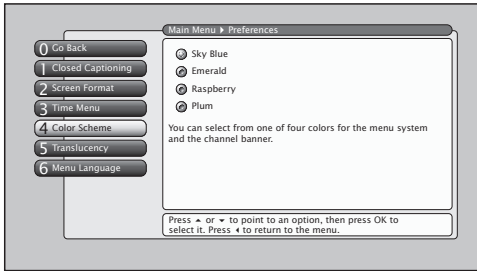

## Color Scheme

Select from among four colors (*Sky Blue, Emerald, Raspberry, and Plum*) to change the color of the menu system and banner.

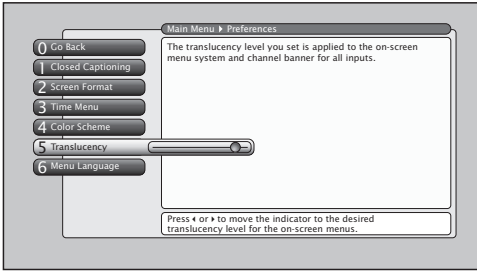

## Translucency

You can change the translucency (see-through) level of the menu screens. Adjust the slider by using the left and right arrow buttons.

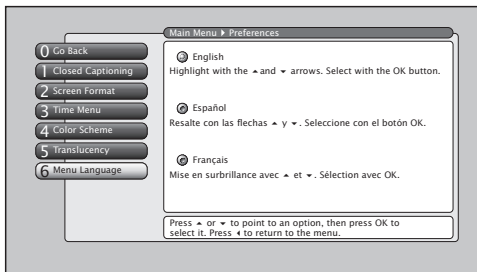

## Menu Language

The menu language can be changed to one of three languages: *English, Spanish* or *French*. The menu language can also be selected when using the *Assisted Setup* menu.

# Reference

### Chapter Overview:

- Troubleshooting
- HDTV Specifications
- Accessory Information
- Limited Warranty
- FCC Information
- Care and Cleaning
- Index

Changing Entertainment. Again.



## Troubleshooting

Most problems you encounter with your TV can be corrected by consulting the following troubleshooting list.

**Note for U.S. customers:** *If you prefer, we can provide you with the name of an Authorized Service Representative who will visit you home for a fee to install your electronic entertainment system and to instruct you in its operation. For details about this service, call 1-888-206-3359. For additional assistance while using your RCA product, please visit [www.rca.com/customersupport](http://www.rca.com/customersupport).*

### TV Problems

---

#### TV won't turn on

- Press the TV button or ON/OFF button while remote is in TV mode and there's a source of power to the outlet or outlet strip.
- Make sure the TV is plugged in.
- Check the wall receptacle (or extension cord) to make sure it is "live" by plugging in something else.
- Something might be wrong with your remote control. Press the POWER button on the front of the TV. If the TV turns on, check the remote control solutions on page 60.
- When you first plug your TV into an outlet, the Power indicator on the front panel will light for approximately 15 seconds and then go off during the initialization of the TV. The TV can only be turned on after the Power indicator goes off. This happens every time power is reapplied to the TV.
- *Remote Setup* might be set to the wrong option. Press MENU/OK on the front panel. Select *Connections*, then *Special Features*, then *Remote Setup*. Choose *TV (default)*.

#### Buttons don't work

- If you're using the remote control, press the TV button first to make sure the remote is in TV mode.
- The front panel controls may be locked (disabled). Use the remote control to unlock the front panel controls by selecting the *Front Button Block* in the *Parental Controls* menu and choosing *Front Buttons Unblocked*.
- Unplug the TV for five minutes and then plug it back in. Turn the TV on and try again.

#### TV turns off while playing

- Sleep Timer or Wake-Up Timer may have been activated. Go to page 55 for instructions.
- Electronic protection circuit may have been activated because of a power surge. Wait 30 seconds and then turn on again. If this happens frequently, the voltage in your house may be abnormally high or low.
- Unplug. Wait five minutes. Plug in again.

#### TV turns on unexpectedly

- Wake-Up Timer may have been activated. Go to page 55 for instructions.

#### Blank screen

- Make sure you have connected the component to the TV correctly.
- Make sure the component connected to the TV is turned on and tuned to the corresponding Video Input Channel.
- Try another channel, or press the INPUT or ANT•CAB button.

#### Unusual sound quality

- Check the *Graphic Equalizer* and *Sound Logic* settings.
- Check if SAP is turned on.
- Check that the *Audio Mode* is set to your language.

## No sound, picture okay

- Maybe the sound is muted. Try pressing the volume up button to restore sound.
- If using an S-Video connection, component video and composite video, remember to also connect the component's L and R AUDIO OUT jacks to the TV's L and R INPUT jacks.
- Make sure the correct *Audio Processor* mode (*Mono* or *Stereo* and *Expanded*) is selected.
- Check the *Maximum* and *Initial Volume* settings in the *Special Features* menu.

## Channel search finds few channels

- The cable connected to the CABLE and/or ANTENNA INPUT jack might be loose.
- Your off-air antenna might be getting a weak signal. Move it higher or get a bigger antenna.
- If you have cables connected to the CABLE and ANTENNA jacks, try swapping the cables. Cable needs to be connected to the CABLE INPUT; off-air antenna needs to be connected to the ANTENNA INPUT.
- If you have a cable box, you can't connect it to the ANTENNA jack. Connect it to the CABLE INPUT or a Video Input jack.
- Select all the options in the *Channel Search* menu, and retry channel search.

## Can't select certain channel

- May be blocked or not approved in the *Parental Controls* menu.
- If using a VCR, check to make sure the TV/VCR button on the VCR is in the correct mode (press the TV/VCR or INPUT button on your VCR).
- You usually can't change channels when a menu is on the screen (press the CLEAR button).

## Noisy stereo reception

- May be a weak station. Use Audio menu to choose *Mono* sound.

## No picture, no sound but TV is on

- The channel might be blank — change channels.
- If you're watching your VCR and it's connected with coaxial cable to the CABLE/ANTENNA jack, tune the TV to channel 3 or 4 (whichever channel is selected on the 3/4 switch on the back of your VCR). Also check to make sure the TV/VCR button on the VCR is in the correct mode (press the TV/VCR or INPUT button on your VCR).
- If a channel doesn't exist and you tune to scrambled QAM channel, *Unusable Signal* appears.

## Sound okay, picture poor

- Check antenna and video connections. Make sure all of the cables are firmly connected to the jacks and they're not damaged.
- Try adjusting sharpness function to improve weak signals. Go to page 44 for more instructions.
- Press the FORMAT button repeatedly to view the picture in different video formats. Analog channels may look better when you use the Normal video format (the video format appears on the right side of the channel banner).

## Black box appears on the screen

- Closed-captioning might be on. Check the *Caption Display* control panel in the *Preferences* menu. Go to page 53 for more instructions.

# References

---

## Video and audio are out of sync

- If your TV is connected to an audio/video (A/V) receiver or home theatre system via the DIGITAL AUDIO OUTPUT jack, read the following information.

If you've connected a component to your A/V receiver, such as a DVD player or satellite receiver, you may experience a slight delay between the audio heard and the video seen. This occurs because the digital audio is sent directly to the speakers while the video must be processed inside the TV before it is displayed.

- If the component has Component Video (Y, Pb, Pr) jacks, connect these jacks to the TV's Y, Pb, Pr jacks to minimize the discrepancy. This works best if the component supports Progressive Scan technology.
- If necessary, you can connect the component directly to the TV using L/R audio jacks and bypassing the A/V receiver or you can program an audio delay in the A/V receiver so the audio and video match up (not all audio equipment has the ability to program delays). Check the audio/video Receiver's manual.

## ***The Remote Control Doesn't Work***

---

- Something might be between the remote and the remote sensor on the component. Make sure there is a clear path.
- Maybe the remote isn't aimed directly at the component that you're trying to operate.
- Maybe remote is not in TV Mode. Press the TV button so the remote controls the TV.
- Maybe batteries in remote are weak, dead, or installed incorrectly. Put new batteries in the remote. (Note, if you remove the batteries, you may have to reprogram the remote to operate other components.)
- You might need to reset the remote: remove batteries and press the number 1 button for at least 60 seconds. Release the 1 button, replace the batteries, and if necessary, program the remote again.

## ***Problems with V-Chip/Parental Controls***

---

### **The rating limits don't work**

- You must lock the settings. Go to the *Main Menu* (press MENU on your remote), select *Parental Controls*, select *Lock TV*.

### **I don't remember my password and I want to unlock the TV**

- If you forget your password, put the remote in TV mode. Simultaneously press and hold MENU/OK on the television and VOL down on the remote for 3 seconds. Nothing appears on the screen, Parental Controls simply unlock and you can re-enter a password via *Lock TV*.

### **The V-Chip won't let me watch a program even though it's not rated as violent.**

- Maybe the movie was given an NR (Not Rated) status. After you block movie ratings, you must set *V-Chip Unrated* to View separately in order to view movies with an NR rating.

## HDTV Specifications\*\*

<b>Tuning Capability</b>	Channel Tuning .....	NTSC/ATSC/64 QAM - 256 QAM
	Digital Cable Compatibility .....	64 QAM - 256, QAM, HDMI/DVI, ..... Component, CableCARD slot
<b>Video</b>	3:2 Pull Down (Film Mode) .....	Reverse Diagonal
	4:3 Format Control (Screen) .....	Normal, Cinerama, Zoom, Stretch, ..... Auto Format Switch
	Adjustable Color Warmth .....	Yes
	Adjustable Picture Control .....	Yes
	Auto Color Control .....	Yes
	Auto Flesh .....	Yes
	Convergence .....	Auto and Manual
	Comb Filter .....	Digital 3 Y/C
	Contrast Expand .....	Off, Low, High
	Optimum Contrast, High-Resolution Screen .....	Yes
	Edge Enhancement .....	Off, Low, High
	Horizontal Resolution (Picture Width) .....	1280
	Horizontal Viewing Angle (Alpha H) .....	80°
	Hybrid Lens System .....	Yes
	Picture Presets .....	Vibrant (Day), Natural, ..... Cinematic (Night), Videogame, ..... Professional, Personal
	Picture Screen Pitch .....	Screen .52mm
	Scan Rate Converter .....	Yes
	Vertical Viewing Angle (Alpha V) .....	14°
	Wide Band Video Amplifier .....	Yes
<b>Sound</b>	Audio Power (Watts) Front Speakers .....	20 Watts/Channel
	Balance Control .....	Yes
	Broadcast Stereo w/dbx <sup>†</sup> Noise Reduction .....	Yes
	Sound Presets .....	7 plus Personal
	Front Speakers .....	2 Mid/Tweeter/Pass Rad
	Fully Enclosed Speaker System .....	Yes
	Graphic Equalizer .....	7 band
	Second Audio Program (SAP) .....	Yes
Sound Logic Audio Leveler .....	Yes	

<sup>†</sup> dbx is a registered trademark of Carillon Electronics Corporation.

\*\*Specifications are subject to change.

# References

---

## Convenience

Auto Channel Search .....	Yes
Multilingual On-screen Display .....	English, French, Spanish
Auto Tuning .....	Yes
Closed Captioning .....	Analog & Digital
Front Button Block .....	Yes
Commercial Skip .....	Yes
Parental Control with USA & Canada V-Chip .....	Yes
Picture Reset .....	Yes, in Menu
Picture-in-Picture (PIP) .....	Analog on Analog
Picture Memory Presets for Video Inputs .....	Yes
(Individual Memory)	
Clock (Time), Sleep and Wake-Up Timers .....	Yes

## Front Panel

Stereo Headphone Jack .....	3.5mm Stereo Mini-jack
Front A/V Input .....	Composite with S-Video

## Back Panel Inputs/Outputs

Composite A/V Inputs with Autodetect S-Videos .....	1 set
Component with composite audio/video inputs .....	1 - Y,Pr,Pb (RCA Jacks)
.....	SYNCROSCAN
Antenna/Cable Inputs .....	2 - RF
HDMI/DVI Input (with Audio Input menu selection) .....	1
Broadband Connection (Ethernet RJ45) .....	1
Audio/Video (Record) Output .....	1
Digital Audio Output .....	1
CableCARD slot .....	1



## Accessory Information

Below are accessories available to compliment your product. Prices are subject to change without notice. All accessories are subject to availability.

A shipping and handling fee will be charged upon ordering, and we are required by law to collect the appropriate sales tax for each individual state, county and locality to which the merchandise is being sent.

### How to Order

To place your order by phone, have your Visa, MasterCard or Discover Card ready and call the toll-free number listed below. Use this number only to place an order for accessory items listed on these two pages.

**1-800-338-0376**

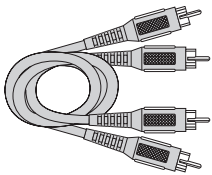

**Monaural VCR Dubbing Audio/Video Cable** is a double cable that lets you connect the video and audio jacks of two VHS VCRs to duplicate tapes. It can also be used to connect a VCR to your TV. The cable is color-coded and shielded. It has RCA-type phono plugs on each end. Gold-Tipped cable, VH83 (6-ft)

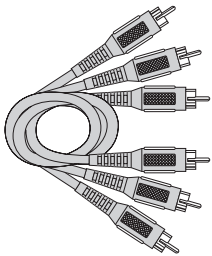

**Stereo VCR Dubbing Audio/Video Cable** is a triple cable that lets you connect the VIDEO and AUDIO jacks of stereo components. Gold-Tipped cable, VH84 (6-ft)

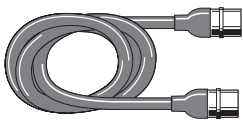

**Push-on Cable\*** attaches to the round antenna connectors (called 75-ohm F-type) on the back of your VCR or TV. The ends push on for a quick connection. VH89 (6-ft)

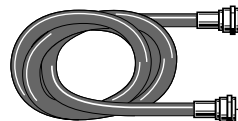

**Screw-on Cable\*** attaches to the round antenna connectors (called 75-ohm F-type) on the back of your VCR or TV. The ends screw onto the connectors for a secure connection. VH82 (6-ft), VH81 (3-ft)

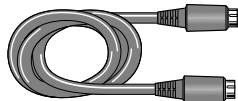

**S-Video Cable** has multi-pin connectors on each end for connecting S-Video components to your TV. VH976 (6-ft), VH913 (12-ft)

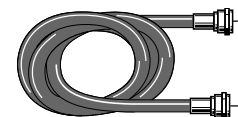

**RG-6 Coaxial Burial Cable** with weatherproof "F" connectors. D905

\* This accessory is intended for use with an off-air or cable TV signal distribution and is not suitable for distribution of the satellite signal originating from your satellite dish antenna.

# References

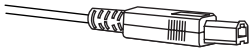

**Optical/SPDIF cables** help you connect to a component with an Optical Audio In jack, such as a Dolby Digital decoder or receiver. DV3 (3-ft), DV6 (6-ft)



**Network Category 6 cables** help you connect to a component with an ethernet jack. High performance 500MHz Bandwidth, 5x bandwidth of standard Category 5 cable TP603N (3-ft), TP607N (7-ft), TP625N (25-ft)

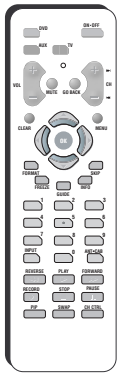

Remote Control

**Remote Control** This is the remote control that came packed with your TV. Replacements or spares can be ordered as needed.

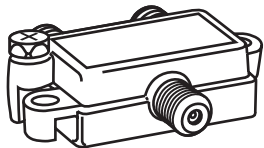

2-way Splitter (VH47)

4-way Splitter (VH49)

**2-way Signal Splitter, 4-way Signal Splitter\*** helps you connect to other components.



ANT200

**Amplified VHF/UHF/FM Antenna** allows you to easily switch from the antenna signal to cable or satellite easily without disconnecting antenna.

Description	Part No.	Price
Screw-on antenna cable* (3-ft)	VH81	\$3.95
Screw-on antenna cable* (6-ft)	VH82	\$4.95
Push-on antenna cable* (6-ft)	VH89	\$5.95
Weatherproof "F" Connector (2)	VHD905	\$5.95
Monaural VCR Dubbing Cable (6-ft)	VH83	\$5.95
Stereo VCR Dubbing Cable (6-ft)	VH84	\$9.95
S-Video Cable (6-ft)	VH976	\$7.95
S-Video Cable (12-ft)	VH913	\$14.95
2-way Signal Splitter*	VH47	\$3.95
4-way Signal Splitter*	VH49	\$6.95
Amplified Antenna	ANT200	\$49.95
Antenna Mixer	193984	\$11.15
Remote Control	265092	*
Optical/SPDIF Cable (3-ft)	DV3	\$15.95
Optical/SPDIF Cable (6-ft)	DV6	\$19.95
Audio•Video Adapter	228449	\$4.45
Diplexer	VHD920	\$19.95
Network Category 6 Cable (3-ft)	TP603N	\$14.95
Network Category 6 Cable (7-ft)	TP607N	\$19.95
Network Category 6 Cable (25-ft)	TP625N	\$29.95

\* Price not available at time of printing

\* This accessory is intended for use with an off-air or cable TV signal distribution and is not suitable for distribution of the satellite signal originating from your satellite dish antenna.

## Limited Warranty

### What your warranty covers:

- Defects in materials or workmanship.

### For how long after your purchase:

- One year from date of purchase for labor.
- One year from date of purchase for parts.
- Two years from date of purchase for the picture tube.

The warranty period for rental units begins with the first rental or 45 days from date of shipment to the rental firm, whichever comes first.

### What we will do:

- Pay an Authorized Service Center the labor charges to repair your unit.
- Pay an Authorized Service Center for the new, or at our option, refurbished replacement parts and picture tube required to repair your unit.

### How you get service:

- Call 1--877-RCA-HDTV and have your unit's date of purchase and model/serial number ready.
- A representative will troubleshoot your problem over the phone.
- If the representative determines that you should receive service, they will provide you with the name(s) of the Authorized Service Center in your area.
- Contact the Service Center and arrange for home or pick up, repair, and return service, provided that your unit is located within the geographic territory covered by an Authorized Service Center. If not, you must take your unit to the Service Center location at your own expense, or pay for the cost the Service Center may charge to transport your unit to and from your home.
- Proof of purchase in the form of a bill of sale or receipted invoice which is evidence that the product is within the warranty period must be presented to obtain warranty service. For rental firms, proof of first rental is also required.

### What your warranty does not cover:

- Customer instruction. (Your Owner's Manual describes how to install, adjust, and operate your unit. Any additional information should be obtained from your dealer.)
- Installation and related adjustments.
- Damage resulting from non-approved installation methods.
- Signal reception problems not caused by your unit.
- Damage from misuse or neglect.
- Batteries.
- Images burnt onto the screen.
- A television that has been modified or incorporated into other products, or is used for institutional or other commercial purposes.
- A unit purchased or serviced outside the U.S.A.
- Acts of nature, such as but not limited to lightning damage.

### Product Registration:

- Please complete and mail the Product Registration Card with your unit. It will make it easier to contact you should it ever be necessary. The return of the card is not required for warranty coverage.

# References

---

## **Limitation of Warranty:**

- **THE WARRANTY STATED ABOVE IS THE ONLY WARRANTY APPLICABLE TO THIS PRODUCT. ALL OTHER WARRANTIES, EXPRESS OR IMPLIED (INCLUDING ALL IMPLIED WARRANTIES OF MERCHANTABILITY OR FITNESS FOR A PARTICULAR PURPOSE) ARE HEREBY DISCLAIMED. NO VERBAL OR WRITTEN INFORMATION GIVEN BY THOMSON INC., ITS AGENTS OR EMPLOYEES SHALL CREATE A WARRANTY OR IN ANY WAY INCREASE THE SCOPE OF THIS WARRANTY.**
- **REPAIR OR REPLACEMENT AS PROVIDED UNDER THIS WARRANTY IS THE EXCLUSIVE REMEDY OF THE CONSUMER. THOMSON INC. SHALL NOT BE LIABLE FOR INCIDENTAL OR CONSEQUENTIAL DAMAGES RESULTING FROM THE USE OF THIS PRODUCT OR ARISING OUT OF ANY BREACH OF ANY EXPRESS OR IMPLIED WARRANTY ON THIS PRODUCT. THIS DISCLAIMER OF WARRANTIES AND LIMITED WARRANTY ARE GOVERNED BY THE LAWS OF THE STATE OF INDIANA. EXCEPT TO THE EXTENT PROHIBITED BY APPLICABLE LAW, ANY IMPLIED WARRANTY OF MERCHANTABILITY OR FITNESS FOR A PARTICULAR PURPOSE ON THIS PRODUCT IS LIMITED TO THE APPLICABLE WARRANTY PERIOD SET FORTH ABOVE.**

## **How State Law relates to warranty:**

- Some states do not allow the exclusion nor limitation of incidental or consequential damages, or limitations on how long an implied warranty lasts, so the above limitations or exclusions may not apply to you.
- This warranty gives you specific legal rights, and you also may have other rights that vary from state to state.

## **If you purchased your unit outside the United States:**

- This warranty does not apply. Contact your dealer for warranty information.

**Service calls which do not involve defective materials or workmanship are not covered by this warranty. Costs of such service calls are the sole responsibility of the purchaser.**

## FCC Information

This equipment has been tested and found to comply with the limits for a Class B digital device, pursuant to Part 15 of the FCC Rules. These limits are designed to provide reasonable protection against harmful interference in a residential installation. This equipment generates, uses, and can radiate radio frequency energy and, if not installed and used in accordance with the instructions, may cause harmful interference to radio communications. However, there is no guarantee that interference will not occur in a particular installation. If this equipment does cause harmful interference to radio or television reception, which can be determined by turning the equipment off and on, the user is encouraged to try to correct the interference by one or more of the following measures:

- Reorient or relocate the receiving antenna.
- Increase the separation between the equipment and receiver.
- Connect the equipment into an outlet on a circuit different from that to which the receiver is connected.
- Consult the dealer or an experienced radio/TV technician for help.

This Class B digital apparatus complies with Canadian ICES-003

## Care and Cleaning

**CAUTION:** Turn OFF your TV before cleaning.

You can clean the TV as required, using a soft lint-free cloth. Be sure to occasionally dust the ventilation slots in the cabinet to help assure adequate ventilation.

The TV's screen may be cleaned with a soft, lint-free cloth as well. Take care not to scratch or mar the screen. If necessary, you may use a cloth dampened with warm water.

Never use strong cleaning agents, such as ammonia-based cleaners, or abrasive powder. These types of cleaners will damage the TV.

While cleaning do not spray liquid directly on the screen, or allow liquid to run down the screen and inside the TV. Also, avoid placing drinks or vases with water on top of the TV. This could increase the risk of fire or shock hazard or damage to the TV.

## Symbols

3:2 pulldown 46

## A

Accessories 63  
Action buttons 43  
Advanced Settings 46  
Age-based rating  
  Blocking 33  
  Viewing 33  
Age-Based Ratings  
  Canada, English 35  
  Canada, French 37  
  USA 32  
Analog captions 53  
Analog TV channel 29  
ANT•CAB button 20  
ANTENNA INPUT jack 10  
Arrow buttons 20  
Aspect ratio 28  
Assisted setup 16  
Audio  
  remote codes 25  
Audio menu 47  
  Audio Connections 49  
  Audio Mode 48  
  Audio Processor 47  
  Balance 48  
  Dynamic Bass 49  
  Equalizer presets 47  
  SAP 48  
  Sound logic 48  
Audio Mode 48  
Audio mode display 28  
AUDIO OUTPUT  
  Digital 10  
Audio processor 47  
AUDIO/VIDEO OUTPUT Jacks  
  8  
Authorized service 7, 58, 65  
Auto color 45  
Auto converge 45  
Auto Tuning 37, 51  
  Antenna Input 37  
  Cable Input 37  
  Front Input 38  
  HDMI/DVI Input 38  
  Input 1 38  
  Input 2 38  
Automatic code search 22  
AUX button 20

## B

Balance 48  
Batteries, installing 16  
Batteries, remote 60

Block  
  Age-Based Ratings 33  
  Front Panel 37  
  Movie ratings 34  
  Specific Content Themes 33  
  V-Chip Unrated Program 36  
Buttons  
  ANT•CAB 20  
  Arrows 20  
  AUX 20  
  CH CTRL 20  
  Channel down 11, 20  
  Channel up 11, 20  
  CLEAR 20  
  Don't work 58  
  DVD 20  
  FORMAT 20  
  FORWARD 21  
  FREEZE 20  
  Front panel 11  
  GO BACK 20  
  GUIDE 20  
  INFO 20  
  INPUT 21  
  MENU 21  
  MENU/OK 11  
  Number 20  
  OK 21  
  ON•OFF 21  
  PAUSE 21  
  PIP 21, 38  
  PLAY 21  
  Power 11  
  RECORD 21  
  Remote control 20  
  REVERSE 21, 22  
  STOP 21  
  SWAP 21  
  TV 21  
  Volume up/down 11, 21

## C

Cable Box remote codes 25  
Cable INPUT jack 10  
CableCARD  
  slot 10  
  Tools menu 52  
CableCARD Tools 52  
Cables  
  to connect 6  
Canada  
  English ratings 36  
  French ratings 36  
  V-Chip unrated program 36  
Canada V-Chip 35  
Caption  
  display 53  
  priority 54  
  style 54  
Captions  
  Analog 53  
  Background color 54  
  Background opacity 54  
  Color 54  
  Digital 54  
  Font 54  
  Opacity 54  
  Size 54  
Care and cleaning 67  
CH CTRL button 20  
Channel  
  banner 28  
  information 28  
  Initial 51  
  lists 30  
  search 17, 50  
  up/down buttons 11, 20  
Channel numbers 29  
Channels  
  Digital or Analog 29  
Chart, of connections 7  
Choice fields 43  
Choice lists 43  
Choose Your Connection 7  
Cinematic picture setting 44  
Cinerama, screen format 55  
Cleaning and care 67  
CLEAR button 20  
Clock display 28  
Closed captioning 53  
Code list  
  Audio 25  
  Cable Box 25  
  DVD 25  
  HD Receiver 25  
  Satellite Receiver 25  
  TV 25  
  VCR 24  
Color 44  
Color scheme 56  
Color Warmth 45  
Commercial skip 28  
Components, connecting 7  
Connections  
  TV, CableCARD 15  
  TV, HDMI or DVI Component  
  14  
  TV, Satellite Receiver, VCR 13  
  TV, VCR, DVD Player 12  
Connections menu 49  
  Audio Tuning 51  
  Channel search 50  
  Ethernet setup 52  
  Signal source 51  
  Signal Strength 50  
  Software upgrade 50  
  Special Features 51

  Video Input Setup 51  
Content Themes 32  
  Blocking 33  
  Viewing 34  
Contrast 44  
Contrast Expand 46  
Control panels 42  
Controls  
  Menus 42  
  Parental 30  
  Reset 46  
Convergence 45

## D

Digital Audio Out 49  
DIGITAL AUDIO OUTPUT jack  
  10  
Digital captions 54  
Digital TV channel 29  
Direct entry programming 22  
DVD button 20  
DVD remote codes 25  
DVI Audio Input 49  
Dynamic Bass 49

## E

EAS 39  
Edge Enhancement 46  
Emergency Alert System 39  
Equalizer presets 47  
ETHERNET jack 9  
Ethernet setup 52  
Expanded Stereo 47

## F

FCC information 67  
Film Mode 46  
Format  
  Screen 55  
FORMAT button 20  
FORWARD button 21  
FREEZE button 20  
Front panel  
  block 37  
  Buttons 11  
  jacks 11

## G

GO BACK button 20  
Graphic equalizer 47  
GUIDE button 20

## H

HD Receiver remote codes 25  
HDMI/DVI jack 10  
HDTV specifications 61  
Help text 42

## I

Icons  
  Channel banner 28  
Indicator 20  
Indirect light 6  
INFO button 20  
Initial channel 51  
Initial volume 51  
INPUT 1 jacks 8  
INPUT 2 jacks 9  
INPUT button 21

## J

Jacks  
  ANTENNA INPUT 10  
  CABLE INPUT 10  
  COMPONENT/COMPOSITE  
  INPUT 9  
  COMPOSITE INPUT 9  
  DIGITAL AUDIO OUTPUT 10  
  Ethernet 9  
  Front panel 11  
  HDMI/DVI 10  
  S-VIDEO 9

## L

Language  
  Menu 17, 56  
LED, front panel 58  
Limited warranty 65

## M

Main Menu 42  
Maximum volume 51  
MENU button 21, 42  
Menu controls 42  
  Action buttons 43  
  Choice fields 43  
  Choice lists 43  
  Numeric entries 43  
  Sliders 43  
Menu language 17, 56  
MENU/OK button 11  
Menus 42  
  Audio 47  
  Moving through 42  
  Picture Quality 44  
  Preferences 52  
Mode

  Audio 48  
  Mono 47  
Mute  
  Closed captioning 53  
Mute button 21

## N

Natural picture setting 44  
Normal, screen format 55  
Number buttons 20  
Numeric entries 43

## O

OK button 21  
ON•OFF button 21  
Overheating 6

## P

Parental Control icon 28  
Parental controls 30  
  Channel lists 30  
  Editing channels 31  
  Lock/unlock 30  
Password, V-chip 60  
PAUSE button 21  
Personal picture setting 44  
Picture Quality menu 44  
  Advanced Settings 46  
  Auto color 45  
  Color warmth 45  
  Contrast Expand 46  
  Convergence 45  
  Edge Enhancement 46  
  Picture presets 44  
  Picture settings 44  
  Reset controls 46  
Picture settings 44  
Picture-in-Picture 38  
PIP  
  Arrow buttons 38  
  Buttons 38  
  CH CTRL button 38  
  FREEZE button 38  
  operation 38  
  Problems 39  
  SWAP button 38  
PIP button 21, 38  
PIP, using 38  
PLAY button 21  
Power button 11  
Power surges 6  
Preferences menu 52  
  Analog captions 53  
  Caption style 54  
  Captions Priority 54  
  Closed captioning 53  
  Color scheme 56

  Digital captions 54  
  Menu language 56  
  Screen Format 55  
  Time 55  
  Translucency 56  
Problems  
  Audio 59  
  Parental controls 60  
  Remote control 60  
  TV 58  
  V-Chip 60  
Professional picture setting 44  
Program title 28  
Programming the remote  
  Automatic code search 22  
  Direct entry 22  
Pulse code modulation 49

## R

Rating Limits  
  movies 34  
Ratings  
  Blocking movie 34  
  Viewing movie 34  
RECORD button 21  
Remote  
  Programming 21  
Remote control  
  Batteries 16  
  Buttons 20  
  Code list 24  
  Indicator 20  
Remote Setup 52  
Reset controls 46  
REVERSE button 21

## S

S-VIDEO jack 9  
SAP 48  
SAP display 28  
Satellite Receiver remote codes  
  25  
Screen Format 55  
Search  
  Automatic code 22  
  Channels 50  
Second audio program 48  
Service, authorized 7  
Setup  
  Ethernet 52  
Setup, assisted 16  
Signal source 51  
Signal Strength 50  
SKIP button 21  
Sleep timer 28, 55  
Sliders 43  
Software upgrade 50

Sound logic 48  
Special Features 51  
Specifications 61  
  Back panel 62  
  Front panel 62  
  Sound 61  
Stand 6  
Stereo 47  
  Expanded 47  
STOP button 21  
Stretch, screen format 55  
Subchannels 50  
SWAP button 21

## T

Things to Consider Before You  
  Connect 6  
  Time display 28  
  Time of Day 55  
Timer  
  Sleep 55  
  Wake-Up 55  
Translucency 56  
Troubleshooting 58  
Turn on TV 16  
TV button 21  
TV, CableCARD connection 15  
TV, HDMI or DVI component  
  connection 14  
TV problems 58  
TV remote codes 25  
TV, Satellite Receiver, VCR  
  connection 13  
TV, VCR, DVD Player connec-  
  tion 12

## U

USA  
  V-Chip TV ratings 31

## V

V-Chip 30  
  Age-Based Ratings 31  
  Blocking age-based 33  
  Blocking Movies 34  
  Canada 31, 35  
  Content Themes 31  
  USA 31  
  USA TV ratings 31  
  Viewing age-based rating 33  
V-chip display 28  
V-Chip rating screen 32  
V-Chip unrated program 36  
VCR remote codes 24  
Vibrant picture setting 44  
Video Input Setup 51

# Index

---

Videogame picture setting 44  
Viewing  
    Movie ratings 34  
    Specific content themes 34  
Volume  
    Initial 51  
    Maximum 51  
Volume up button 11  
Volume up/down buttons 21

## W

Warranty, limited 65

## Y

Y/Video Pb Pr jacks 9

## Z

Zoom, screen format 55



*This page intentionally left blank*

*This page intentionally left blank*

*This page intentionally left blank*

*This page intentionally left blank*

*This page intentionally left blank*

*This page intentionally left blank*

*This page intentionally left blank*

**Visit the RCA website at [www.rca.com](http://www.rca.com)**

---

Please do not send any products to the Indianapolis address listed in this manual or on the carton. This will only add delays in service for your product.

**Thomson Inc.**  
**10330 North Meridian Street**  
**Indianapolis, IN 46290**

©2004 Thomson Inc.  
Trademark(s)® Registered  
Marca(s) Registrada(s)  
Printed in USA  
TOCOM 16339320

