



# Projection Television Models WD-52825, WD-62825



## Owner's Guide

TV Information:

Use this space to record the model and serial numbers of your television. This information is on the back of your TV.

Model number \_\_\_\_\_

Serial number \_\_\_\_\_

visit our website at  
[www.mitsubishi-tv.com](http://www.mitsubishi-tv.com)

	<b>CAUTION</b> <b>RISK OF ELECTRIC SHOCK</b> <b>DO NOT OPEN</b>	
<b>CAUTION: TO REDUCE THE RISK OF ELECTRIC SHOCK, DO NOT REMOVE COVER (OR BACK). NO USER SERVICEABLE PARTS INSIDE. REFER SERVICING TO QUALIFIED SERVICE PERSONNEL.</b>		

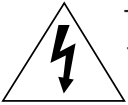

The lightning flash with arrowhead symbol within an equilateral triangle is intended to alert the user of the presence of uninsulated “dangerous voltage” within the product’s enclosure that may be sufficient magnitude to constitute a risk of electric shock.



The exclamation point within an equilateral triangle is intended to alert the user to the presence of important operating and maintenance (servicing) instructions in the literature accompanying the appliance.

This TV is very heavy! Exercise extreme care when lifting or moving. Lifting or moving the TV requires a minimum of two adults. To prevent damage to your TV, your TV should not be jarred or moved while it is turned on. Power off your TV before moving it.

Portions of the advanced circuitry of this TV must continue to operate even when the TV is turned off. Some of these circuits therefore need to be cooled at all times. A low power standby fan may be heard in a quiet environment. This is normal operation.

***Custom cabinet installation must allow for proper air circulation around the television.***

## **STAND REQUIREMENT**

**CAUTION:** Mitsubishi TV model WD-52825 is for use only with Mitsubishi stand, model MB-52825. Mitsubishi TV models WD-62825 is for use only with Mitsubishi stand model MB-62825. Use with other stands is capable of resulting in instability causing possible injury.

**WARNING:** TO REDUCE THE RISK OF FIRE OR ELECTRIC SHOCK, DO NOT EXPOSE THIS APPLIANCE TO RAIN OR MOISTURE.

**CAUTION:** TO PREVENT ELECTRIC SHOCK, MATCH WIDE BLADE OF PLUG TO WIDE SLOT, FULLY INSERT.

**NOTE TO CATV SYSTEM INSTALLER:** THIS REMINDER IS PROVIDED TO CALL THE CATV SYSTEM INSTALLER’S ATTENTION TO ARTICLE 820-40 OF THE NEC THAT PROVIDES GUIDELINES FOR THE PROPER GROUNDING AND, IN PARTICULAR, SPECIFIES THAT THE CABLE GROUND SHALL BE CONNECTED TO THE GROUNDING SYSTEM OF THE BUILDING, AS CLOSE TO THE POINT OF CABLE ENTRY AS PRACTICAL.

# **FCC Declaration of Conformity**

Product: Projection Television Receiver

Models: WD-52825, WD-62825

Responsible Party: Mitsubishi Digital Electronics America, Inc.  
9351 Jeronimo Road  
Irvine, CA 92618-1904

Telephone: 949-465-6000

This device complies with Part 15 of the FCC Rules. Operation is subject to the following two conditions:

- (1) This device may not cause harmful interference, and
- (2) this device must accept any interference received, including interference that may cause undesired operation.

**Note:** This equipment has been tested and found to comply with the limits for a Class B digital device, pursuant to part 15 of the FCC Rules. These limits are designed to provide reasonable protection against harmful interference in a residential installation. This equipment generates, uses and can radiate radio frequency energy and, if not installed and used in accordance with the instructions, may cause harmful interference to radio communications. However, there is no guarantee that interference will not occur in a particular installation. If this equipment does cause harmful interference to radio or television reception, which can be determined by turning the equipment off and on, the user is encouraged to try to correct the interference by one or more of the following measures:

- Reorient or relocate the receiving antenna.
- Increase the separation between the equipment and the receiver.
- Connect the equipment into an outlet on a circuit different from that to which the receiver is connected.
- Consult the dealer or an experienced radio/TV technician for help.

**CAUTION:** To assure continued FCC compliance, the user must use a shielded video interface cable with bonded ferrite cores at both ends, when using the PC or HDMI input.

**Changes or modifications not expressly approved by Mitsubishi could cause harmful interference and would void the user's authority to operate this equipment.**

# Contents

## Chapter 1 Television Overview

TV Accessories.....	10
Special Features.....	11
Front Control Panel .....	12
Front Panel Inputs and Media Card Slots .....	13
Back Panel.....	14

## Chapter 2 Connecting

External Devices & NetCommand® Setup .....	18
Wall Outlet Cable or Cable Box.....	19
CableCARD™ Technology .....	20
Single Lead Antenna .....	21
Separate UHF and VHF Antennas .....	21
Antenna or Wall Outlet Cable to a VCR (Audio & Video) .....	22
Cable Box to a VCR (Audio & Video) .....	23
A/V Receiver or Stereo System.....	24
Satellite Receiver or Other Device with S-Video .....	24
DVD Player with Component Video.....	25
Computer with a PC Monitor Output.....	25
DTV Receiver	
with Component Video .....	26
with RGB, HV Video .....	27
M-Link Control.....	28
RS-232C Connection .....	28
HDMI Device.....	28
DVI Device .....	28
IR Emitter NetCommand® .....	29
Compatible IEEE 1394 Devices .....	30
Helpful Hints .....	32

## Chapter 3 NetCommand® Setup and Editing

Using the Remote Control with NetCommand®.....	34
Remote Control Functions: Overview.....	35
Remote Control Functions:	
Operation.....	36
Care .....	36
Sleep Timer .....	36
NetCommand® OnScreen Buttons .....	37
3D Graphical Viewpoint® Menu System.....	38
NetCommand® Initial Setup .....	39
Edit NetCommand®	
Add an A/V Receiver .....	41
Add Devices .....	44
Change Devices .....	48
Delete Devices.....	48
Finish Screen.....	48

## **Chapter 4 IEEE 1394 Devices and NetCommand® Controlled Recordings**

IEEE 1394 Devices and NetCommand® Control .....	50
Adding IEEE 1394 Devices Automatically.....	51
Device Selection Menu.....	53
Using the DEVICE MENU Button to Display Menus.....	54
Using the Guide Button to Display ChannelView™ and Menus.....	55
NetCommand® Controlled	
Recordings .....	56
Record List .....	56
Peer-to-Peer Connections.....	57
Using TV Disc & A/V Discs.....	58
Direct VCR Recording from an Antenna or Cable Screen .....	59
PC Viewing .....	60
MediaCommand™ and Media Card Playback.....	61

## **Chapter 5 TV Menu Screen Operations**

Main Menu Choices.....	64
Setup Menu .....	65
NetCommand® Menu .....	67
Antenna Menu .....	68
Time Menu.....	70
Captions Menu .....	71
V-Chip Lock Menu.....	73
AudioVideo Menu .....	76
A/V Settings Descriptions .....	77
Operation of PIP and POP.....	79

## **Chapter 6 Special Features**

Display Formats .....	82
Device Control with NetCommand®.....	85
Appendix A: Bypassing the V-Chip Lock.....	87
Appendix B: Specifications .....	89
Appendix C: Remote Control Programming Codes.....	91
Appendix D: On-Screen Information Displays .....	94
Appendix E: NetCommand® Specialized Device Keys .....	95
Appendix F: Cleaning and Service .....	96
Appendix G: Diamond Shield™ Removal .....	97
Appendix H: Filter Cleaning.....	98
Lamp Cartridge Replacement.....	99
Troubleshooting.....	101
Additional Information .....	106
Index.....	107
Warranty .....	109

# IMPORTANT SAFEGUARDS

Please read the following safeguards for your TV and retain for future reference. Always follow all warnings and instructions marked on the television.

## 1. Read, Retain and Follow All Instructions

Read all safety and operating instructions before operating the TV. Retain the safety and operating instructions for future reference. Follow all operating and use instructions.

## 2. Heed Warnings

Adhere to all warnings on the appliance and in the operating instructions.

## 3. Cleaning

Unplug the TV from the wall outlet before cleaning. Do not use liquid, abrasive or aerosol cleaners. Cleaners can permanently damage the cabinet and screen. Use a lightly dampened cloth for cleaning.

## 4. Attachments and Equipment

Never add any attachments and/or equipment without approval of the manufacturer as such additions may result in the risk of fire, electric shock or other personal injury.

## 5. Water and Moisture

Do not use the TV where contact with or immersion in water is possible. Do not use near bath tubs, wash bowls, kitchen sinks, laundry tubs, swimming pools, etc.

## 6. Accessories



Do not place the TV on an unstable cart, stand, tripod, or table. The TV may fall, causing serious injury to a child or adult and serious damage to the TV. Use only with a cart, stand, tripod, bracket or table recommended by the manufacturer, or sold with the TV. Any mounting of the TV should follow the manufacturer's instructions, and should use mounting accessories recommended by the manufacturer.

An appliance and cart combination should be moved with care. Quick stops, excessive force, and uneven surfaces may cause the appliance and cart combination to overturn.

## 7. Ventilation

Slots and openings in the cabinet are provided for ventilation and to ensure reliable operation of the TV and to protect it from overheating. Do not block these openings or allow them to be obstructed by placing the TV on a bed, sofa, rug, or other similar surface. Nor should it be placed over a radiator or heat register. If the TV is to be placed in a rack or bookcase, ensure that there is adequate ventilation and that the manufacturer's instructions have been adhered to.

## 8. Power Source

This TV should be operated only from the type of power source indicated on the marking label. If you are not sure of the type of power supplied to your home, consult your appliance dealer or local power company.

## 9. Grounding or Polarization

This TV is equipped with a polarized alternating current line plug having one blade wider than the other. This plug will fit into the power outlet only one way. If you are unable to insert the plug fully into the outlet, try reversing the plug. If the plug should still fail to fit, contact your electrician to replace your obsolete outlet. Do not defeat the safety purpose of the polarized plug.

## 10. Power-Cord Protection

Power-supply cords should be routed so that they are not likely to be walked on or pinched by items placed upon or against them, paying particular attention to cords at plugs, convenience receptacles, and the point where they exit from the TV.

## 11. Lightning

For added protection for this TV during a lightning storm, or when it is left unattended and unused for long period of time, unplug it from the wall outlet and disconnect the antenna or cable system. This will prevent damage to the TV due to lightning and power-line surges.

# IMPORTANT SAFEGUARDS, continued

## 12. Power Lines

An outside antenna system should not be located in the vicinity of overhead power lines or other electric light or power circuits, or where it can fall into such power lines or circuits. When installing an outside antenna system, extreme care should be taken to keep from touching such power lines or circuits as contact with them might be fatal.

## 13. Overloading

Do not overload wall outlets and extension cords as this can result in a risk of fire or electric shock.

## 14. Object and Liquid Entry

Never push objects of any kind into this TV through openings as they may touch dangerous voltage points or short-out parts that could result in fire or electric shock. Never spill liquid of any kind on or into the TV.

## 15. Outdoor Antenna Grounding

If an outside antenna or cable system is connected to the TV, be sure the antenna or cable system is grounded so as to provide some protection against voltage surges and built-up static charges.

Article 810 of the National Electric Code, ANSI/NFPA No. 70-2002, provides information with respect to proper grounding of the mast and supporting structure, grounding of the lead in wire to an antenna discharge unit, size of grounding conductors, location of antenna discharge unit, connection to grounding electrodes, and requirements for the grounding electrode.

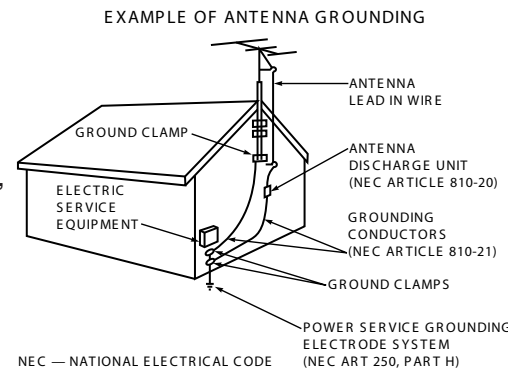

## 16. Servicing

Do not attempt to service this TV yourself as opening or removing covers may expose you to dangerous voltage or other hazards. Refer all servicing to qualified service personnel.

## 17. Damage Requiring Service

Unplug the TV from the wall outlet and refer servicing to qualified service personnel under the following conditions:

- (a) When the power-supply cord or plug is damaged.
- (b) If liquid has been spilled, or objects have fallen into the TV.
- (c) If the TV has been exposed to rain or water.
- (d) If the TV does not operate normally by following the operating instructions, adjust only those controls that are covered by the operating instructions as an improper adjustment of other controls may result in damage and will often require extensive work by a qualified technician to restore the TV to its normal operation.
- (e) If the TV has been dropped or the cabinet has been damaged.
- (f) When the TV exhibits a distinct change in performance - this indicates a need for service.

## 18. Replacement Parts

When replacement parts are required, be sure the service technician has used replacement parts specified by the manufacturer or have the same characteristics as the original part. Unauthorized substitutions may result in fire, electric shock or other hazards.

## 19. Safety Check

Upon completion of any service or repair to the TV, ask the service technician to perform safety checks to determine that the TV is in safe operating condition.

## 20. Heat

The product should be situated away from heat sources such as radiators, heat registers, stoves or other products (including amplifiers) that produce heat.

## Our Thanks...

*Thank you for choosing Mitsubishi as your premier Home Entertainment provider.*

*This Owner's Guide describes the features and functions of your Mitsubishi widescreen, high definition TV. We urge you to examine this Owner's Guide to become familiar with the innovative features and operations this unique television offers.*

*The very core of our corporate philosophy is to provide our customers with the very best. Our development team at Mitsubishi has worked to provide you with a television that defines "state-of-the-art," with the capability to meet your needs now and in the future.*

*Whether this is your first Mitsubishi electronic product, or an addition to your Mitsubishi collection, we believe you and your family will continue to enjoy your Mitsubishi home theater for many years.*

*Thank you,*

**Mitsubishi Digital Electronics America, Inc.**



# Chapter . . .



## Television Overview

TV Accessories .....	10
Special Features .....	11
Front Control Panel.....	12
Front Panel Inputs and Media Card Slots .....	13
Back Panel .....	14

# TV Accessories

Please take a moment to review the following list of items to ensure that you have received everything including:

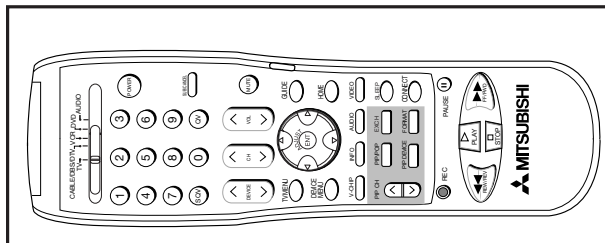

1. Remote Control



2. Two AA Batteries

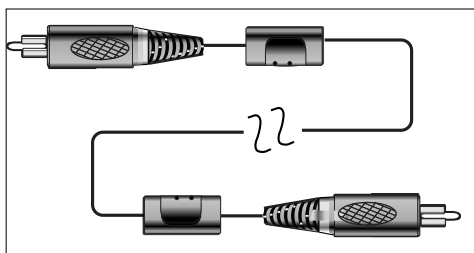

3. One Digital Audio Cable (sends the audio of digital channels to a digital audio video receiver).

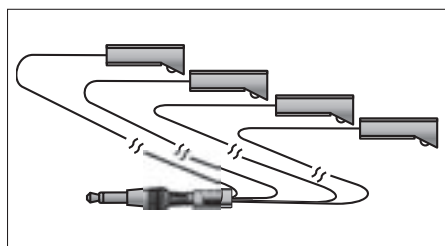

4. One Quadruple IR Emitter Cable (allows NetCommand to control other devices)

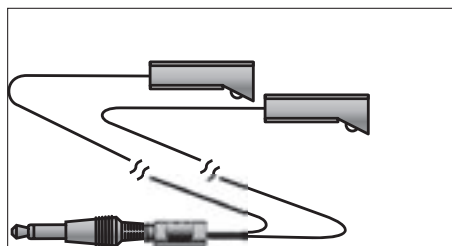

5. One Double IR Emitter Cable (allows NetCommand to control other devices)

6. Product Registration Card (not pictured)

7. Owner's Guide (not pictured)

8. Quick Reference Card (not pictured)

## Special Features

Your new High Definition widescreen television has many special features that make it the perfect center of your home entertainment system, including:

### High Definition DLP™ Display System

Your widescreen Mitsubishi HDTV uses Texas Instruments Digital Light Processing™ technology. This TV is truly a high performance multimedia monitor uniquely capable of both stunning high definition video images and clear detailed high resolution PC images. Your TV is able to accept video signals in the standard video scanning rates of 480i, 480p, 720p and 1080i. It is also able to accept signals with PC resolutions from VGA (640 x 480) through XGA (1024 x 768). When using a compatible graphics card and controlling software, this TV is also able to accept the custom PC resolution of 720p (1280 x 720). All signals will be converted to 720p for final display.

### TV Disc Internal Personal Video Recorder (PVR)

TV Disc is an internal 120GB high definition hard disk drive recorder (also called a personal video recorder or PVR). It is able to record digital and analog programs received from CableCARD™ channels, Antenna 1, Antenna 2, devices connected to Input 1, 2, 3 or IEEE 1394 devices. This exciting feature may record as much as 12 hours of high definition TV programming and includes live TV pause with instant replay. Now you can record a high definition program and watch it later without any picture quality loss and without a VCR. Recordings on the TV Disc can be sent by IEEE 1394 to D-VHS VCRs or to other IEEE 1394 compatible TVs. When recording analog programs, TV Disc will even use Dolby Digital Record to convert the analog stereo to high quality digital stereo compatible with Dolby Digital decoding surround receivers.

### Digital Cable Ready (CableCARD™)

Your widescreen Mitsubishi HDTV is “Plug-and-Play” ready. It can descramble a cable provider’s one-way digital signals with the use of a CableCARD security module. The CableCARD is used in place of a traditional cable box to access digital cable programming (including high definition). Contact your local cable provider for availability information and service details.

### NetCommand® Home Network Control System

Your widescreen Mitsubishi HDTV offers a new level of networking to combine selected older products with new and future digital products. NetCommand supports IEEE 1394 connections, Audio Video Control system (AV/C), 5C copy protection and IR control of selected older products such as VCRs, DVD players, cable boxes or satellite receivers. NetCommand includes the ability to learn remote control signals directly from many devices, allowing you to customize the NetCommand system in a way that works best for your viewing.

### 16:9 Widescreen Picture Format

Enjoy a full theatrical experience in the comfort of your home. View pictures as film directors intended them. Digital TV broadcasts, DVDs and newer video game consoles support this widescreen format.

### Media Cards

You can display a slideshow of your favorite JPEG pictures or listen to MP3 or WMA audio selections that have been recorded on compatible media cards.

# Front Control Panel

The buttons on the Front Control Panel highlighted in gray are duplicated on the remote control. The top row of labels show the control functions when there are no TV menus displayed on the screen. The bottom row of labels show the control functions when the TV menus are displayed on the screen or when a special function has been activated. See *Remote Control Overview*, for further details on the functions of these buttons.

## System Reset

If the TV will not respond to either the remote control or the front panel controls and/or will not power Off, press the SYSTEM RESET button with a pointed item like the end point of a paperclip. The TV will turn Off and the TIMER light will flash quickly for about one minute. When the TIMER light stops flashing, you may again turn on the TV. The changes you made the last time the TV was on before you used the SYSTEM RESET button may be lost, however, the changes that were previously saved are not lost.



## Indicators

Please refer to the table below for conditions when the indicator lights will display.

COLOR	LAMP LIGHT INDICATOR	TIMER/POWER
None (off)	Power off	Power off
Green (steady light)	n/a	Power on
Green (fast blinking light)	n/a	Starting up*
Green (blinking light)	Power just turned off, TV cooling down (1 minute). Cannot turn the TV back on until blinking stops.	TV Timer is set
Yellow (steady light)	Lamp life end warning. A new lamp should be purchased. See Appendix H.	n/a
Yellow (blinking light)	Lamp cover door is open or no lamp installed. See Appendix H.	n/a
Red (steady light)	Lamp has failed, replacement is required. See Appendix H.	n/a
Red (blinking light)	n/a	n/a

COLOR	STATUS LIGHT INDICATOR
None (off)	Power off
Green (steady light)	n/a
Green (fast blinking light)	n/a
Green (blinking light)	n/a
Yellow (steady light)	Operating temperature is too high. The dust filter may be dirty. See Appendix H. or The room temperature too hot. Turn off TV until the room is cooler.
Yellow (blinking light)	The filter cover is open or not secure. See Appendix H.
Red (steady light)	Service required. Turn off TV and call your dealer or a Mitsubishi Authorized Service Center. See <a href="http://www.mitsubishi.com">www.mitsubishi.com</a> or call 1-800-332-2119.
Red (blinking light)	Service required. Turn off TV and call your dealer or a Mitsubishi Authorized Service Center. See <a href="http://www.mitsubishi.com">www.mitsubishi.com</a> or call 1-800-332-2119.

\*Each time the TV is plugged into a wall electrical outlet, when power is restored after a power failure, or when using the SYSTEM RESET button, this light will flash for about one (1) minute.

## A/V Reset

There may be times when you wish to reset the A/V (Audio and Video) settings back to the factory defaults. To return all of the settings at once, press GUIDE and FORMAT on the front panel at the same time. To reset the defaults for individual devices, use the A/V Memory Reset selection on the AudioVideo menu.

# Front Panel Inputs and Media Card Slots

## Media Card Slots and IEEE 1394 Input/Output

To access the media card slots and IEEE 1394 Input/Output, press on the center panel, labeled PUSH. There are four card slots in the front of the TV that allow the display of JPEG pictures from many digital cameras, MP3 or WMA audio files recorded from computers or other digital recording devices. The card slots are designed for specific types of cards and other cards or objects should not be inserted into the slots as this may damage the TV. CARD-1 slot is compatible with both MultiMediaCard™ (MMC) and Secure Digital (SD) cards. CARD-2 slot is compatible with SmartMedia™ cards. CARD-3 slot is compatible with CompactFlash® cards and CARD-4 is compatible with MEMORY STICK™ cards. See media card (slideshow, playlist) Setup for details about JPEG, MP3 and WMA file types that are compatible with the TV.

The IEEE 1394 input/output allows for convenient connection of IEEE 1394 devices such as some camcorders, to the front of the TV. This connection works the same way as rear IEEE 1394 connections, please refer to the NetCommand® information (Chapter 3) for details.

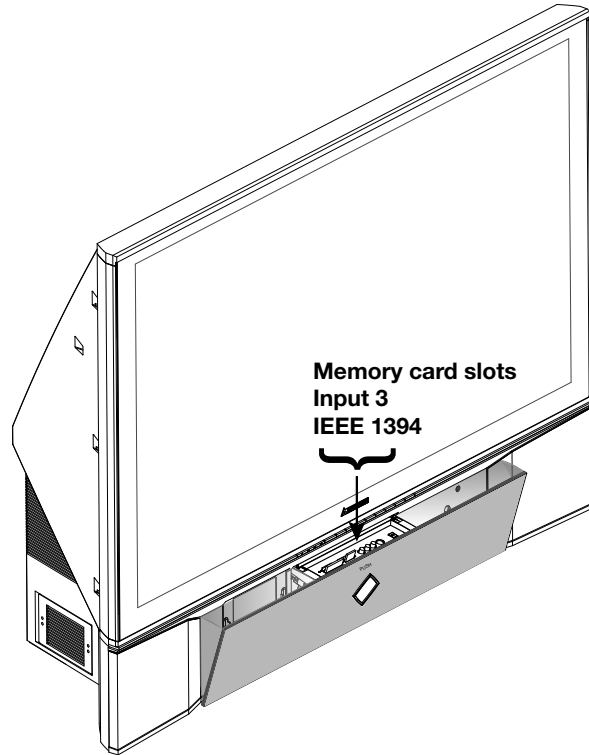

## Input 3

This input can be used for convenient connection of a camcorder or other audio/video device to the TV. Please note that if you connect to the S-VIDEO terminal, the VIDEO terminal is deactivated. The VIDEO terminal is active when there is no S-Video connection.

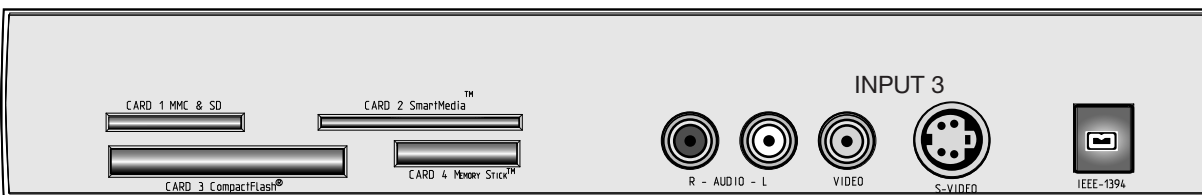

### IMPORTANT

Portions of the advanced circuitry of this TV must continue to operate even when the TV is turned off. Some of these circuits therefore need to be cooled at all times. A low power standby fan may be heard in a quiet environment. This is normal operation.

# Back Panel

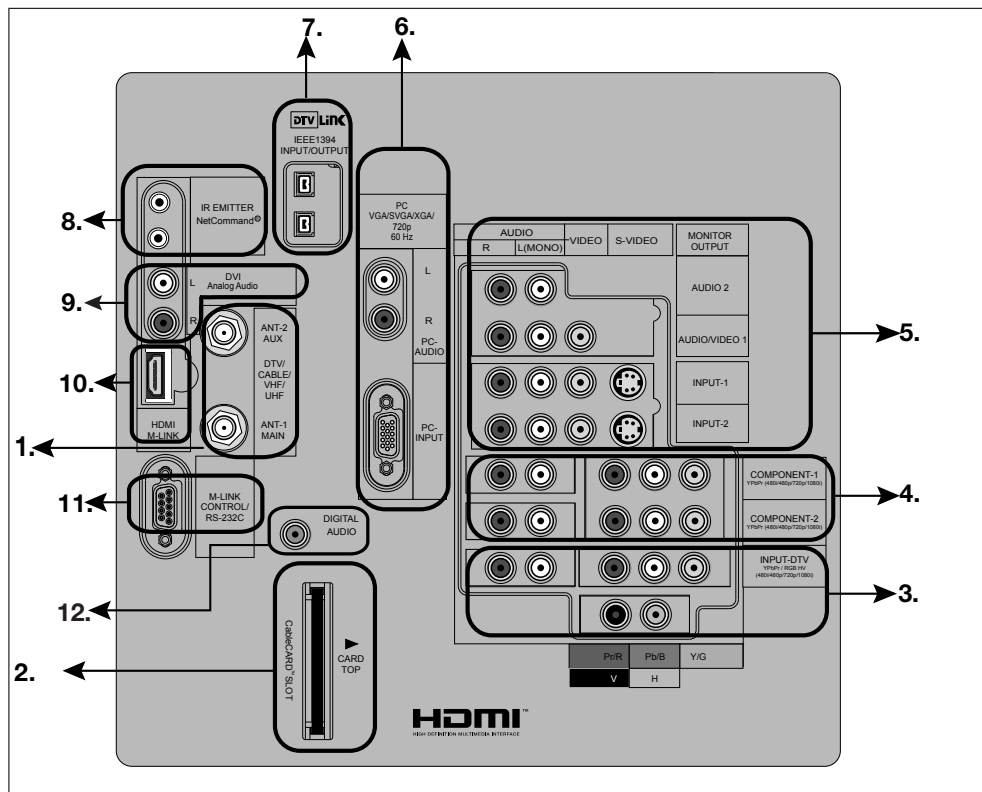

## 1. Antenna (ANT-1 MAIN, ANT-2 AUX)

ANT-1 MAIN and ANT-2 AUX can each receive both digital and analog over-the-air channels from a VHF/UHF antenna or non-scrambled digital/analog cable channels.

Your primary viewing signal source should be connected to ANT-1 MAIN. ANT-1 MAIN must be used to view premium subscription cable TV service authorized by the CableCARD™ access card. The CableCARD access card is provided by your local cable company. ANT-2 AUX can receive over-the-air or non-scrambled cable signals.

## 2. CableCARD™ Slot

The CableCARD access card provided by your cable TV service provider is inserted into this slot. The top of the card should face in the direction the CARD TOP arrow indicates.

CableCARD is a nationwide standard system that allows your local cable TV provider to supply you with an access card customized to your account. This card allows the TV to receive, decode and unscramble the premium digital channels included in your cable TV subscription without the use of a cable box. See page 20 for additional CableCARD information and activation instructions.

If your cable company is not currently offering CableCARD access cards, you will need to use a cable box provided and authorized by your local cable company to view scrambled channels.

## 3. Input-DTV

### YPbPr/RGB HV (480i/480p/720p/1080i)

This input is used to connect an external DTV receiver, and can be configured for YPbPr or RGB plus H&V signal types. Please see Appendix B for signal compatibility.

## 4. Component-1, -2 Inputs

### YPbPr (480i/480p/720p/1080i)

These inputs can be used for the connection of devices with component video outputs, such as a DVD player, external HDTV receiver or compatible video game system. Please see Appendix B for signal compatibility.

## 5. Input-1, -2; Monitor Output (Audio/Video 1, Audio 2)

Input 1 and 2 can be used for the connection of a VCR, Super VHS (S-VHS) VCR, DVD player, standard satellite receiver or other A/V device to the TV. Please note that if S-VIDEO and VIDEO are available for the input, you must choose to connect only one. They cannot both be connected at the same time.

The Monitor Output sends the TV audio and video signals from the antennas or inputs to an A/V receiver or other analog A/V equipment such as a VCR. Digital channels and IEEE 1394 signals will be down converted to analog signals compatible with traditional VCRs. Digital channels or IEEE 1394 signals may be output with copy protection or may display no video signals if they have copy restrictions. There will be only audio and no

# Back Panel, continued

video signals from Monitor Outputs when viewing the Component 1 & 2 inputs, INPUT-DTV, the HDMI input or Cards 1-4.

Monitor Output Audio/Video 1 should be connected to a VCR for recording. Monitor Output Audio 2 should be connected to your A/V receiver for home theater surround sound.

## 6. PC Input and Audio

**(VGA/WVGA/SVGA/WSVGA/XGA/720p, 60Hz)**

This input can be used for the connection of a computer. Please see Appendix B for signal compatibility. Stereo audio inputs are also provided for the PC connection.

## 7. DTV Link™/IEEE1394

These jacks allow the TV to connect to external IEEE 1394 digital products by means of a single cable. Three jacks (one on the front panel and two on the back) are provided for this purpose, which allow for a high degree of flexibility for connecting your NetCommand controlled system. Detailed information regarding IEEE 1394 connection requirements are in Chapter 4.

## 8. IR Emitter-NetCommand®

Two jacks are provided for connecting IR emitters. IR Emitters connected to these jacks are used by the NetCommand system of the TV to control external analog devices such as VCRs, DVDs, cable boxes, satellite receivers and audio receivers.

## 9. DVI Analog Audio

Unlike HDMI, DVI does not carry audio information on the same cable. Use these analog stereo audio inputs when using the HDMI input with a device that outputs DVI instead of HDMI.

## 10. HDMI™/M-Link

M-Link(MonitorLink™) is a Mitsubishi exclusive proprietary digital interface for the display of high quality digital video signals from Mitsubishi products, such as the HD-6000 HDTV Receiver/Controller.

The HDMI (High Definition Multimedia Interface) supports uncompressed standard and high definition digital video formats and existing digital multi-channel audio formats.

Use this input to connect to EIA/CEA-861 compliant devices such as a high definition receiver or DVD player. This input supports 480i, 480p, 720p and 1080i

video formats. It is not intended for use with personal computers or devices outputting video signals with computer resolutions.

This input can also be used as a DVI connection with separate analog audio inputs. An optional HDMI-to-DVI adaptor or cable will be necessary to make this connection and may be available from your local electronics retailer. When using the optional HDMI-to-DVI adapter, the DVI analog audio inputs on your TV allow you to receive left and right audio from your DVI device.

This input is HDCP (High-Bandwidth Digital Copy Protection) compliant.

## 11. M-Link/RS-232C Control

A digital control interface that works in conjunction with M-Link. While M-Link provides the digital video signal, the RS-232 control provides enhanced functioning such as automatic power ON/OFF and input port selection with an external control system. For RS-232C command protocol please visit [www.mitsubishi-tv.com](http://www.mitsubishi-tv.com).

## 12. Digital Audio Output

This output will automatically send Dolby® Digital audio from digital channels and IEEE 1394 devices to a digital Audio/Video receiver. Connect this output to the A/V receiver's coaxial digital audio input. The output will automatically turn off when viewing an analog channel or device, except when using the TV Disc, which converts analog audio to digital. Use Monitor Output Audio 2 to send analog sound to your A/V receiver.

Some digital cable channels send MPEG-1 digital audio instead of Dolby Digital, however, not all A/V receivers can decode MPEG-1 digital audio. This can cause the A/V receivers to produce a loud noise that can damage speakers. For this reason, the TV will automatically turn off the digital audio output when tuned to a channel or device that has MPEG-1 digital audio and send it to the A/V receiver as analog left and right audio from Monitor Output.





## Connecting

External Devices & NetCommand® Setup .....	18
Wall Outlet Cable or Cable Box .....	19
CableCARD™ Technology.....	20
Single Lead Antenna.....	21
Separate UHF and VHF Antennas .....	21
Antenna or Wall Outlet Cable to a VCR (Audio & Video) .....	22
Cable Box to a VCR (Audio & Video) .....	23
A/V Receiver or Stereo System.....	24
Satellite Receiver or Other Device with S-Video .....	24
DVD Player with Component Video.....	25
Computer with a PC Monitor Output .....	25
DTV Receiver	
with Component Video .....	26
with RGB, HV Video .....	27
M-Link Control, RS-232 Connection.....	28
HDMI Device.....	28
DVI Device.....	28
IR Emitter NetCommand® .....	29
Compatible IEEE 1394 Devices.....	30
Helpful Hints .....	32

# Connecting External Devices & NetCommand® Setup

NetCommand is able to control many current audio and video devices by sending remote control signals from the TV to each device through IR emitters. Additionally, it is also able to learn the remote control signals used by most audio video devices not already in the TV's memory. NetCommand can automatically switch the TV and compatible or learned Audio/Video (A/V) Receivers to the correct input used with each device. It is important that the inputs on the TV and A/V receiver back panels match the NetCommand setup that is displayed on-screen.

To simplify the installation of NetCommand, there is a step-by-step on-screen NetCommand Setup procedure in this chapter, which details the type and brands of devices you are connecting to the TV. The NetCommand Setup also assigns preset TV and A/V receiver inputs for each device. You should connect each device to the TV input (both audio and video) and to the A/V receiver (audio) as shown in the figure below.

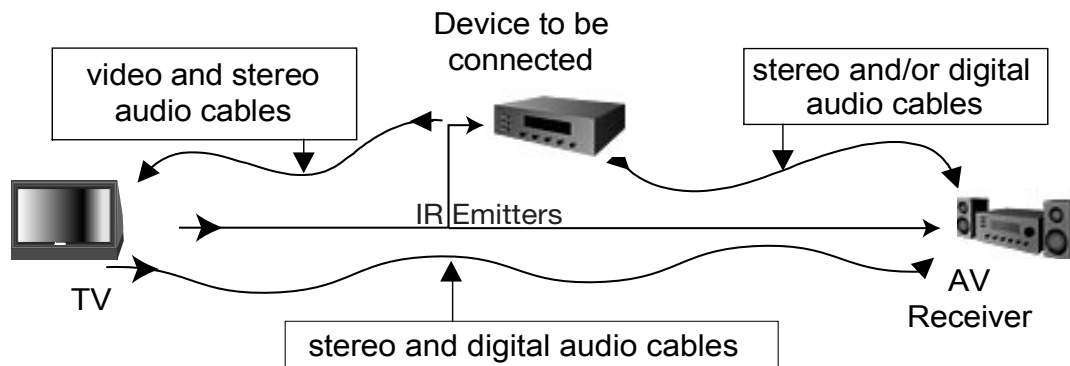

The following charts show which preset inputs you should use on the TV and A/V receiver.

Chart 1 shows TV inputs.

Chart 2 shows the A/V receiver inputs used by A/V receiver models already known by NetCommand.

<b>Chart 1</b>	
<b>Device Audio and Video Outputs to TV Inputs</b>	
<b>Cable for CableCARD™ Service</b>	<b>ANT-1</b>
<b>Antenna/Cable (digital/analog)</b>	<b>ANT-1 if primary viewing source, ANT-2 if secondary viewing source</b>
<b>Cable box</b>	<b>ANT-2</b>
<b>VCR</b>	<b>Input-1</b>
<b>Satellite Receiver (DBS)</b>	<b>Input-2</b>
<b>Camcorder</b>	<b>Input-3 (on front panel)</b>
<b>DVD Player</b>	<b>Component-1</b>

<b>Chart 2</b>	Mitsubishi 1	Mitsubishi 2	Bose	Denon	Integra	Kenwood	Marantz	Pioneer 1	Pioneer 2	Rotel	Sony	Yamaha 1	Yamaha 2
	Model	Model	Model	Model	Model	Model	Model	Model	Model	Model	Model	Model	Model
	M-VR800 & M-VR1000	M-VR900 & M-VR700	Lifestyle @28	AVR-2700	DTR-9.1	VR-2080	SR8200	VSX-D557	VSX-49TX	RSX-1065	STR-DE825	RV-X2095	RX-V2200
<b>Device Audio Output to</b>	<b>AV Receiver Inputs by Name</b>												
VCR	VCR 1	VCR	VCR	VCR-1	Video 1	Video 1	VCR1	VCR/Tape	VCR 1/DVR	Video 2	Video 1	VCR 1	VCR 1
Satellite Receiver	Aux	Cable/DBS	AUX	CD	Video 3	Video 3	DSS	CD	SAT	Video 4	TV/DBS	TV/DBS	D-TV/LD
DVD Player	DVD	DVD	(built-in)	DVD/DVP	DVD	Video 4	DVD	LD/SAT	DVD/LD	Video 5	TAPE/MD	CD	DVD
TV Monitor Output (& Digital Audio)	TV	TV	TV	TV/DBS	Video 4	Video 4	TV	DVD/TV	TV	Video 1	DVD/LD	DVD/LD	CBL/SAT

After using NetCommand Setup, you may go to the NetCommand menu at any time to change the inputs you used for connecting each device, custom name devices, add devices not included in the presets above or delete devices no longer used. See *Edit NetCommand*. See *Helpful Hints*, at the end of this chapter for additional information on device setup.

# Connecting a Wall Outlet Cable or Cable Box

## Wall Outlet Cable

(can be used with a CableCARD™)

Figure 1

It is very important to connect the incoming cable for your primary viewing source to ANT-1, especially for CableCARD™ use.

1. Connect the primary incoming coaxial lead cable to ANT-1 MAIN on the TV back panel.
2. For an optional secondary antenna source, connect an antenna (or cable) to ANT-2 AUX.
3. If you have subscribed to a CableCARD™ service, the CableCARD can now be inserted into the CableCARD SLOT. Using a phillips screwdriver, remove the CableCARD cover screws. Insert the CableCARD, then replace the cover and screws. The top of the card should face in the direction the CARD TOP arrow indicates.

Additional CableCARD information is on page 20.

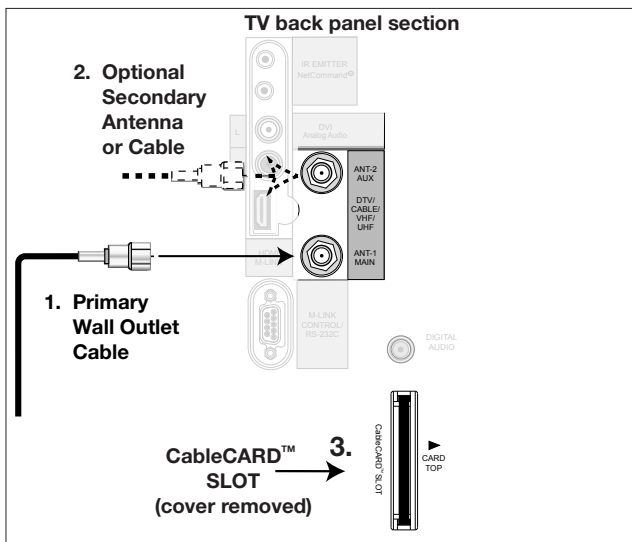

Figure 1. Wall Outlet Cable

## Cable Box

Figure 2

3 coaxial cables and one two-way RF splitter are required. These are not included with the TV.

It is very important to connect the incoming cable for your primary viewing source to ANT-1, especially for CableCARD™ use.

1. Connect the incoming cable to IN on an RF splitter.
2. Connect one coaxial cable from OUT on the RF splitter to ANT-1 MAIN on the TV back panel.
3. Connect one coaxial cable from OUT on the RF splitter to IN on the cable box.
4. Connect one coaxial cable from OUT on the cable box to ANT-2 AUX on the TV back panel.

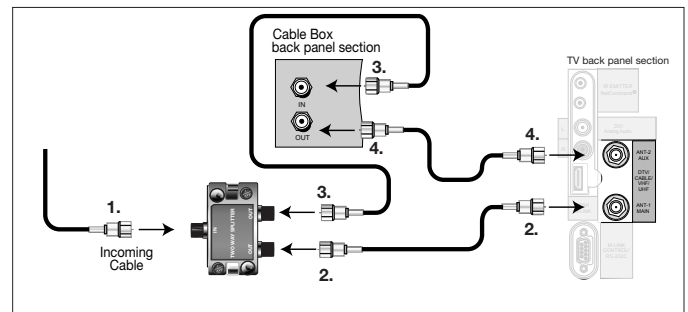

Figure 2. Connecting a Cable Box

**Note:** Net Command® will assume that your Cable Box is connected as shown above. Also, that Channel 3 is the default output channel for the cable box. If either the connections or output channel are different, use the Change option of Edit NetCommand to apply the changes.

### IMPORTANT

Additional connection cables are not provided with the TV. They are available at most electronic stores.

# CableCARD™ Technology

## CableCARD Technology

CableCARD is a nationwide system standard that allows your local cable TV provider to supply you with an access card customized to your account. This card allows your TV to receive, decode and unscramble the premium digital channels included in your cable TV subscription without the use of a cable box. It also allows your cable provider to automatically update and change your subscription. When you move to a new cable provider's area, you simply return the CableCARD to the original cable provider and get a new card from your new cable provider.

Please note that CableCARD is a new technology and your local cable provider may not currently be offering this service. As time passes, this system will become broadly supported by most cable providers.

The CableCARD system is "unidirectional" which means your cable provider can send updates to the access card and TV, however, the TV cannot send back signals such as requests for Video-On-Demand or Pay-per-View programs by remote control.

Digital cable channels authorized by the CableCARD will be available on the Firewire® IEEE 1394 network and can be shared by other products on the network. Some digital channels or programs may not be copied or recorded because of copy restriction limits set by the content owners or copyright holders.

The digital television is capable of receiving analog basic, digital basic and digital premium cable television programming by direct connection to a cable system providing such programming. A security card (CableCARD) provided by your cable operator is required to view encrypted digital programming. Certain advanced and interactive digital cable services such as video-on-demand, a cable operator's enhanced program guide and data-enhanced television services may require the use of a set-top box. For more information call your local cable operator.

Please see *page 19* for instructions on how to insert the CableCARD.

## Using a CableCARD

After inserting a CableCARD into the TV back panel CableCARD slot and powering On the TV, the initialization process begins. An initial screen will automatically display for a few minutes, with information that your Cable Provider will need in order to start service. Please write down this information before calling your cable provider.

Please call XYZ Cable  
at xxx-xxx-xxxx to  
activate cable service.

They will need these numbers:  
Host ID X-XXX-XXX-XXX-XXX  
CableCARD™ ID: X-XXX-XXX-XXX-XXX

See owner's manual for  
further information

An example of an initial screen is shown here. Your screen will display specific information from your cable provider and may not look like this screen.

If you were unable to record the information, you can press TV MENU on the remote and then enter the number 999 and the screen will re-display. You can also press DEVICE MENU when the CableCARD is the selected source and you will be able to select the startup application.

### **IMPORTANT**

**To use a CableCARD, the primary incoming cable must be connected to ANT-1 MAIN.**

# Connecting a Lead Antenna or Separate UHF and VHF Antenna

## Lead Antenna (not for use with CableCARD™)

Figure 3

### For antennas with twin flat lead

A 300-Ohm to 75-Ohm transformer is required. This is not included with the TV, but is available at most electronics stores.

1. For antenna with twin flat leads, connect the 300-Ohm twin leads to the 300-Ohm to 75-Ohm transformer.
2. Push the 75-Ohm side of the transformer onto ANT-1 MAIN on the TV back panel.

### For cable or antenna with coaxial lead

3. Connect the coaxial lead directly to ANT-1 MAIN on the TV back panel.

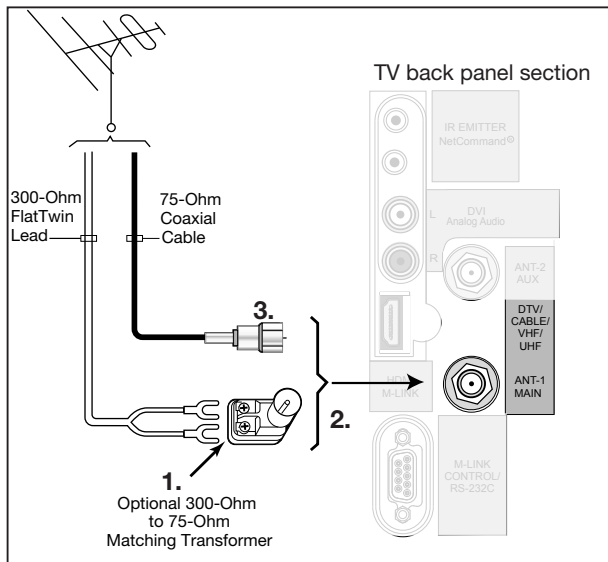

Figure 3. Connecting a Single Antenna

## Separate UHF and VHF Antenna

Figure 4

A UHF/VHF combiner is required. This is not included with the TV.

1. Connect the UHF and VHF antenna leads to the UHF/VHF combiner.
2. Push the combiner onto ANT-1 MAIN on the TV back panel.

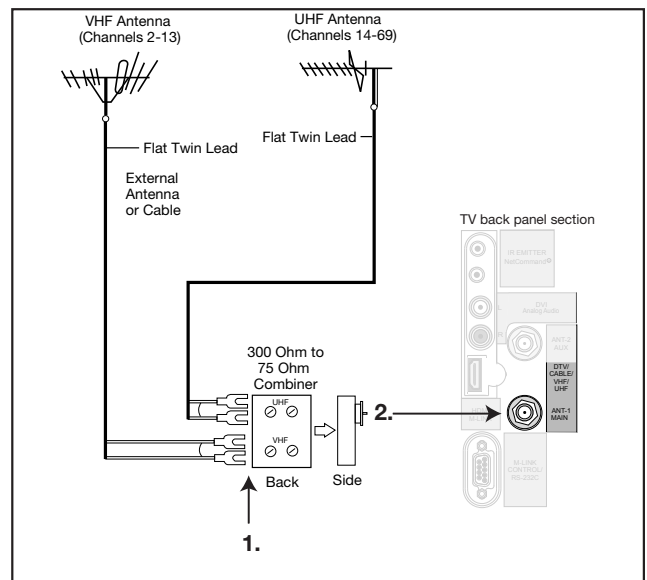

Figure 4. Connecting separate UHF and VHF Antennas

**Mitsubishi strongly recommends against using antennas with twin flat leads. Twin flat lead antenna wires are subject to interference which may adversely affect the performance of the TV. We recommend using coaxial antenna cable.**

# Connecting an Antenna or Wall Outlet Cable to a VCR (Audio & Video)

## Antenna or Wall Outlet Cable to a VCR (Audio & Video)

Figure 5

A two-way RF splitter, 3 coaxial cables, right and left audio cables and a S-Video or Video cables are required. These are not included with the TV.

1. Connect the incoming cable or Antenna to IN on the RF splitter.
2. Connect one coaxial cable from OUT on the RF splitter to ANTENNA IN on the VCR back panel.
3. Connect one coaxial cable from OUT on the RF splitter to ANT-1 MAIN on the TV back panel.
4. To use the TV speakers with the VCR, connect a set of audio cables from AUDIO OUT on the VCR back panel to INPUT-1 AUDIO-LEFT (MONO) and AUDIO-RIGHT on the TV back panel. The red cable connects to the R (right) channel and the white cable connects to the L (left) channel. If your VCR is mono (non-stereo), connect only the white (left) cable.
5. Connect either an S-Video or Video cable from VIDEO OUT on the VCR back panel to INPUT-1 VIDEO on the TV back panel. Only one type of video cable should be connected. S-Video is recommended, if available.
6. For NetCommand® controlled recordings, connect a set of audio cables from AUDIO IN on the VCR back panel to MONITOR OUTPUT AUDIO/VIDEO 1 AUDIO-LEFT (MONO) and AUDIO-RIGHT on the TV back panel. The red cable connects to the R (right) channel and the white cable connects to the L (left) channel.
7. Complete the NetCommand controlled recordings connections by connecting a Video cable from VIDEO IN on the VCR back panel to MONITOR OUTPUT AUDIO/VIDEO 1 on the TV back panel.

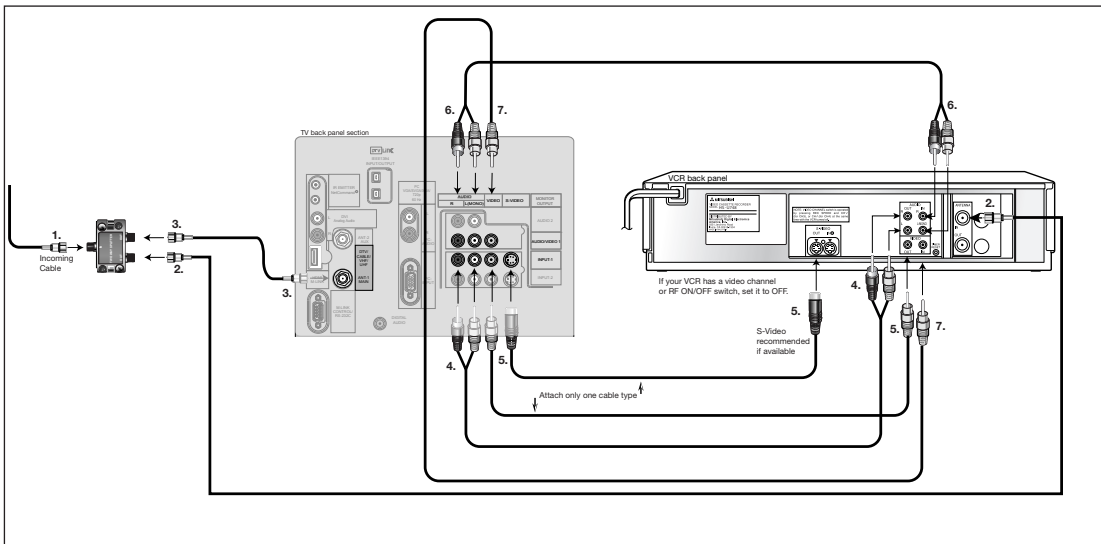

Figure 5. Connecting a VCR to an Antenna or Wall Outlet Cable

**Note:**  
NetCommand® will assume your VCR is connected to inputs as shown on this page. If you use any other inputs for your VCR or add a second VCR, this change must match in the NetCommand system. See *Edit NetCommand... in Chapter 3* for more information.

# Connecting a Cable Box to a VCR (Audio & Video)

## Cable Box to a VCR (Audio & Video)

Figure 6

A two-way RF splitter, 4 coaxial cables, right and left audio cables and an S-Video or Video cable are required. These are not included with the TV.

1. Connect the incoming cable to IN on the RF splitter.
2. Connect one coaxial cable from OUT on the RF splitter to ANTENNA IN on the cable box back panel.
3. Connect one coaxial cable from OUT on the RF splitter to ANT-1 MAIN on the TV back panel.
4. Connect one coaxial cable from OUT on the cable box to ANTENNA IN on the VCR back panel.
5. Connect one coaxial cable from ANTENNA OUT on the VCR back panel to ANT-2 AUX on the TV back panel (optional).
6. To use the TV speakers with the VCR, connect a set of audio cables from AUDIO OUT on the VCR back panel to INPUT-1 AUDIO-LEFT (MONO) and AUDIO-RIGHT on the TV back panel. The red cable connects to the R (right) channel and the white

cable connects to the L (left) channel. If your VCR is mono (non-stereo), connect only the white (left) cable.

7. Connect either an S-Video or Video cable from VIDEO OUT on the VCR back panel to INPUT 1 VIDEO on the TV back panel. Only one type of video cable should be connected. S-Video is recommended, if available.
8. For NetCommand® controlled recordings, connect a set of audio cables from AUDIO IN on the VCR back panel to MONITOR OUTPUT AUDIO/VIDEO 1 AUDIO-LEFT (MONO) and AUDIO-RIGHT on the TV back panel. The red cable connects to the R (right) channel and the white cable connects to the L (left) channel.
9. Complete the NetCommand controlled recordings connections by connecting a Video cable from VIDEO IN on the VCR back panel to MONITOR OUTPUT AUDIO/VIDEO 1 on the TV back panel.

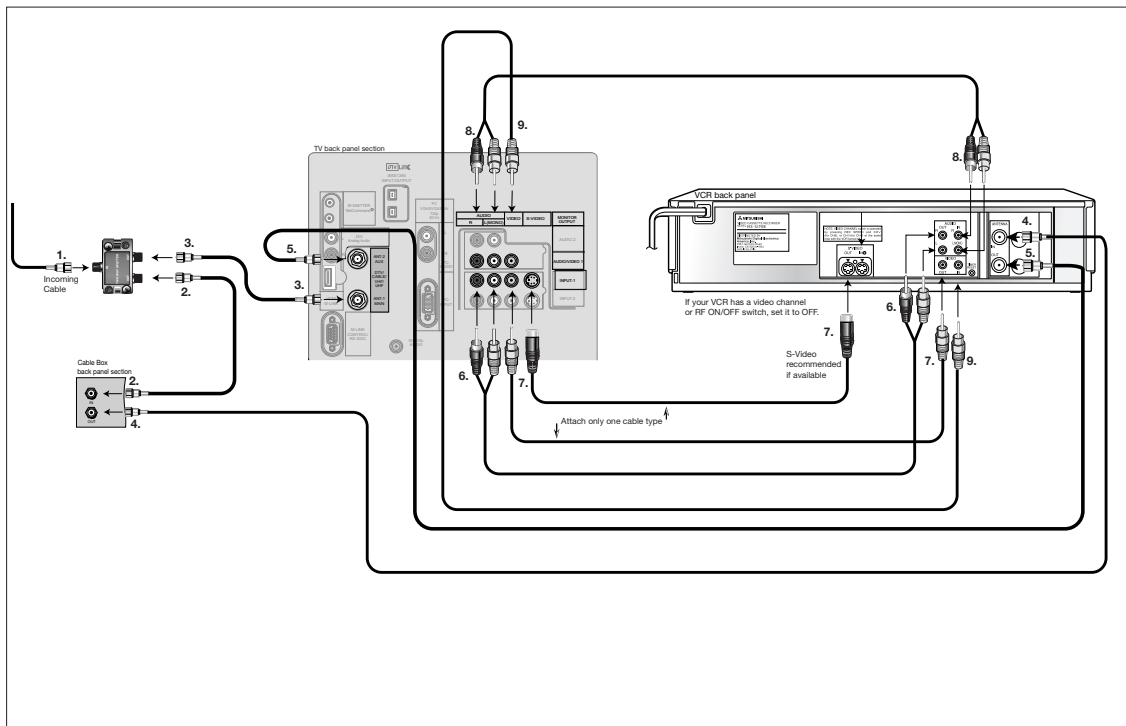

**Note:** NetCommand® will assume your VCR is connected to inputs as shown on this page. If you use any other inputs for your VCR or add a second VCR, this change must match in the NetCommand system. See *Edit NetCommand...* in Chapter 3 for more information.

Figure 6. Connecting a VCR to a Cable Box

# Connecting an A/V Receiver or Stereo System or a Satellite Receiver or Other Device with S-Video

## A/V Receiver or Stereo System

Figure 7

A digital audio cable and stereo audio cables are required. The digital audio cable is provided. The stereo audio cables are not included with the TV.

1. Connect a set of stereo audio cables from OUTPUT AUDIO 2 on the TV back panel to the TV AUDIO INPUT on the back of the A/V receiver. The red cable connects to the R (right) channel and the white cable connects to the L (left) channel.

### To connect a digital A/V receiver with Dolby® Digital surround sound:

2. Connect one end of the digital audio cable supplied with the TV to DIGITAL AUDIO on the back of the TV. Connect the other end to the COAXIAL DIGITAL INPUT on the back of the A/V receiver.

Check A/V receiver's Owner's Guide for information concerning the use of the digital input and switching between the digital sound and analog stereo sound from the TV.

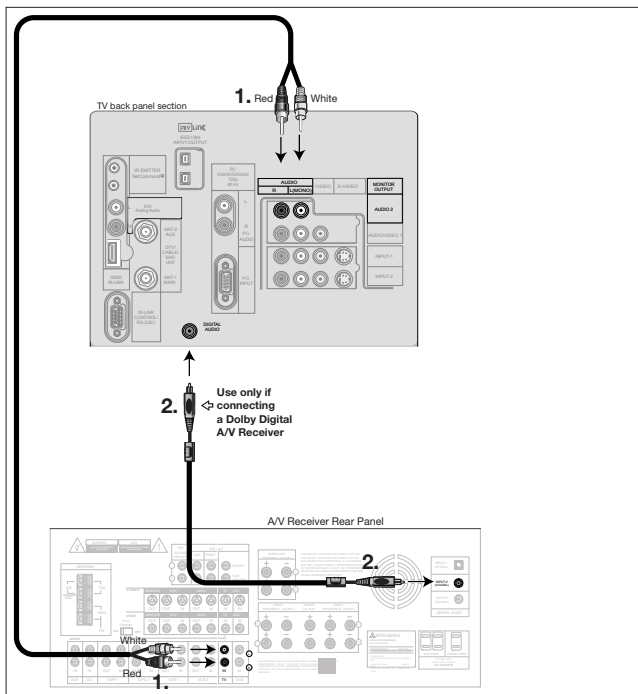

Figure 7. Connecting an A/V receiver

## Satellite Receiver or Other Device with S-Video

Figure 8

An S-Video cable and audio cables are required. These are not included with the TV.

1. Connect an S-Video cable from VIDEO OUT on the satellite receiver back panel to INPUT-2 VIDEO on the TV back panel.
2. Connect a set of audio cables from AUDIO OUT on the satellite receiver back panel to INPUT-2 AUDIO, on the TV back panel. The red cable connects to the R (right) channel and the white cable connects to the L (left) channel.

**Note:** Refer to the Satellite Receiver Owner's Guide for Dish Antenna connections.

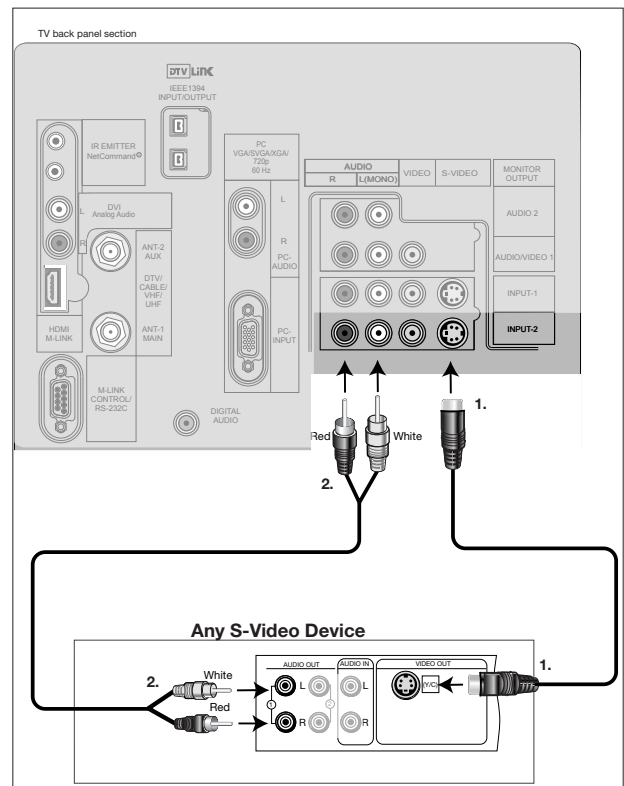

Figure 8. Connecting a Satellite Receiver with S-Video

**Note:** NetCommand® will assume you connected your Satellite Receiver to Input-2. If you add a second Satellite Receiver or use any other inputs for your Satellite Receiver, this change must match in the NetCommand system. See *Editing NetCommand Setup* in Chapter 3 for more information.



# Connecting a DVD Player with Component Video or Computer with a PC Monitor Output

## DVD Player with Component Video

Figure 9

Component video cables and audio cables are required. These are not included with the TV.

1. Connect the Component Video cables from Y/Pr/Pb VIDEO OUT on the back of the DVD player to COMPONENT-1 on the TV back panel, matching the correct connection:
  - **Y** to Y (Green)
  - **Pr** to Pr (Red)
  - **Pb** to Pb (Blue)
2. Connect a set of audio cables from AUDIO OUT on the back of the DVD player to COMPONENT-1 AUDIO Input on the TV back panel. The red cable connects to the R (right) channel, and the white cable connects to the L (left) channel.

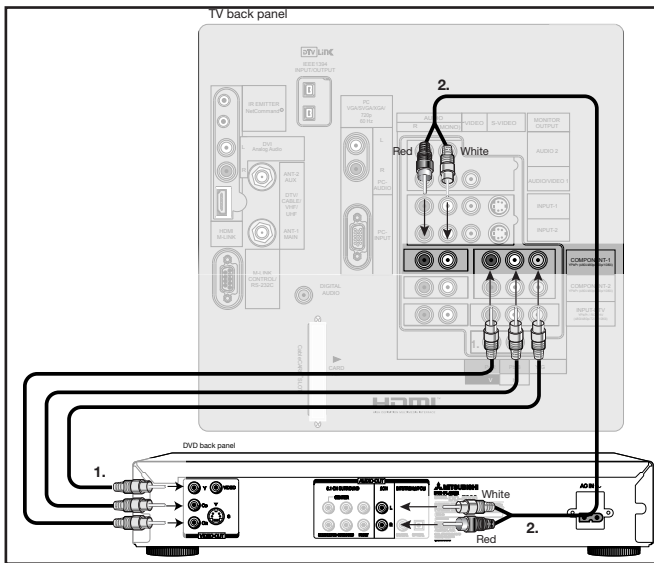

Figure 9. Connecting a DVD Player with Component Video

**Note:** NetCommand® will assume you connected your DVD player to Component-1. If you add a second DVD or use any other inputs for your DVD, this change must match in the NetCommand system. See *Edit NetCommand...* in Chapter 3 for more information.

**IMPORTANT**

See Appendix B for component video signal compatibility information.

For digital audio connections, see your DVD Owner's Guides.

## Computer with a PC Monitor Output

Figure 10

1. Connect PC Monitor Out from the computer to PC Input on the TV back panel using a PC compatible monitor cable. See Appendix B for PC signal compatibility.
2. Connect the L (left) and R (right) audio cables from the computer to PC AUDIO on the TV back panel. If the computer's audio output is a single mini-jack, a mini audio to RCA male "Y" adaptor cable is needed to complete this connection.

**Note:** To utilize the benefits of a digital A/V receiver, connect your computer's digital audio out, if available, to a digital input on your digital A/V receiver.

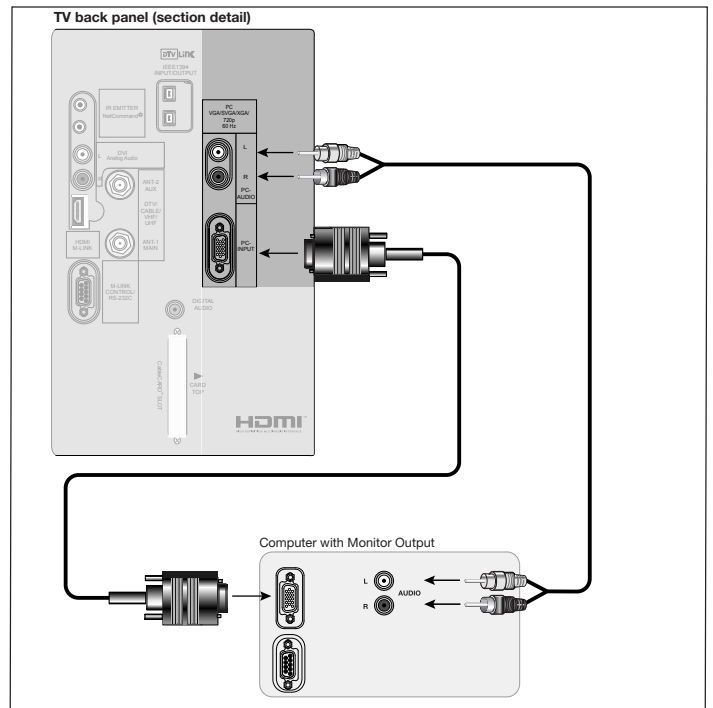

Figure 10. Connecting a Computer with a PC Monitor

**CAUTION:** To ensure continued FCC compliance, the user must use a shielded video interface cable with bonded ferrite cores at both ends when using the PC input.

# DTV Connectors and Adaptors Connecting a DTV Receiver with Component Video

## DTV Connectors and Adaptors

Figure 11

The TV back panel has 5 RCA-type connectors for the Input-DTV. The back panel of your external DTV receiver may use RCA-type connectors or BNC-type connectors. If your DTV receiver comes with BNC type connections, you will need to purchase BNC to RCA adaptors to connect the TV to the DTV receiver. These adaptors should be available at most electronic supply stores.

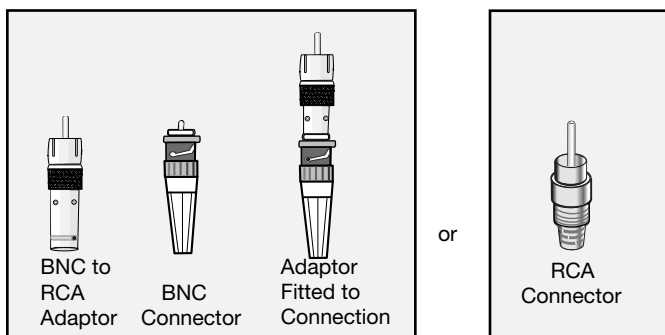

Figure 11. DTV Connectors and Adaptors

**IMPORTANT**

See Appendix B for component video signal compatibility information.

For digital audio connections, see your DTV Receiver and A/V receiver Owner's Guides.

## DTV Receiver with Component Video

Figure 12

A coaxial splitter, RCA component video cables and audio cables are required. These are not included with the TV.

1. Connect the outside antenna, cable or satellite to ANT or SATELLITE IN on the DTV receiver (see your DTV receiver's owner's guide for instructions and cable compatibility).
2. Connect the incoming terrestrial antenna or cable (not satellite) to ANT-1 on the TV back panel (a coaxial splitter, available at most electronic supply stores, may be required to complete this installation).

3. Connect RCA-type cables from the YPrPb outputs

on the DTV receiver to Input-DTV on the TV back panel, matching the correct connections:

DTV Receiver to TV Back panel

- Y to Y
- Pr to Pr
- Pb to Pb

4. Connect the L (left) and R (right) audio cables from the DTV receiver to Input-DTV AUDIO on the TV back panel.

**Note:** To utilize the benefits of a digital A/V receiver, connect your DTV receiver's digital audio out to a digital input on your digital A/V receiver.

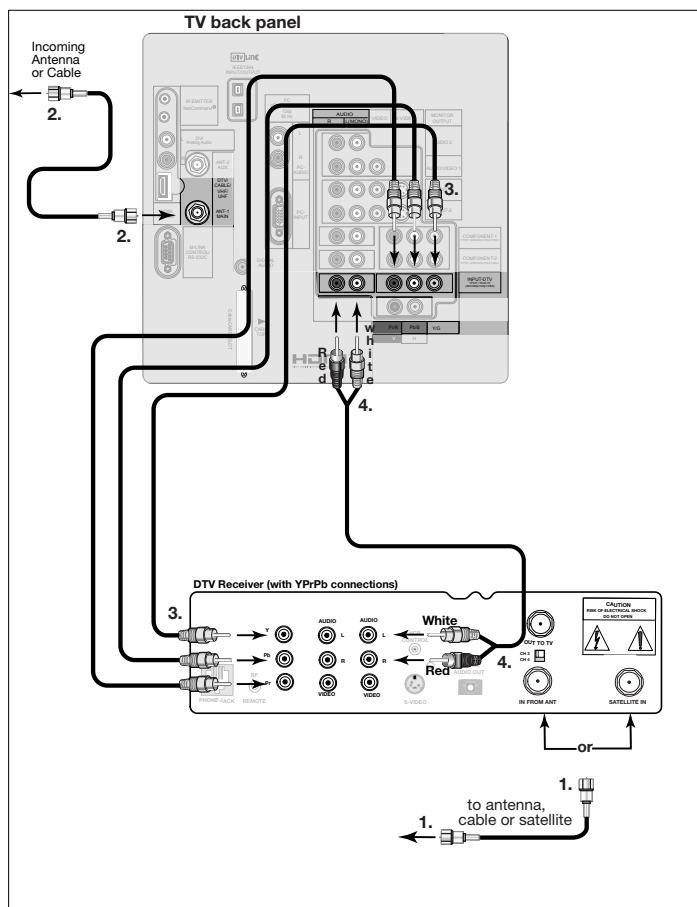

Figure 12. Connecting an External DTV Receiver with Component Video Connections

# Connecting a DTV Receiver with RGB, HV Video

## DTV Receiver with RGB, HV Video

Figure 13

A coaxial splitter, RGB, HV and audio cables are required. These are not included with the TV.

1. Connect the outside antenna, cable or satellite to ANT or SATELLITE IN on the DTV receiver (see your DTV receiver owner's guide for instructions and cable compatibility).
2. Connect the incoming terrestrial antenna or cable (not satellite) to ANT-1 on the TV back panel (a coaxial splitter, available at most electronic supply stores, may be required to complete this installation).
3. Connect RGB cables from the DTV receiver to Input-DTV on the TV back panel.

### DTV Receiver to TV Back Panel

- **G** (green) to Y/G
- **R** (red) to Pr/R
- **B** (blue) to Pb/B

4. Connect the H & V sync signals as shown below:

- **H** (horizontal sync) to H
- **V** (vertical sync) to V

All 5 cables (G,R,B,H and V) must be connected. 3 cables or Sync on green connections are incomplete or not compatible and will not work.

5. Connect the L (left) and R (right) audio cables from the DTV Receiver to Input-DTV AUDIO on the TV back panel.

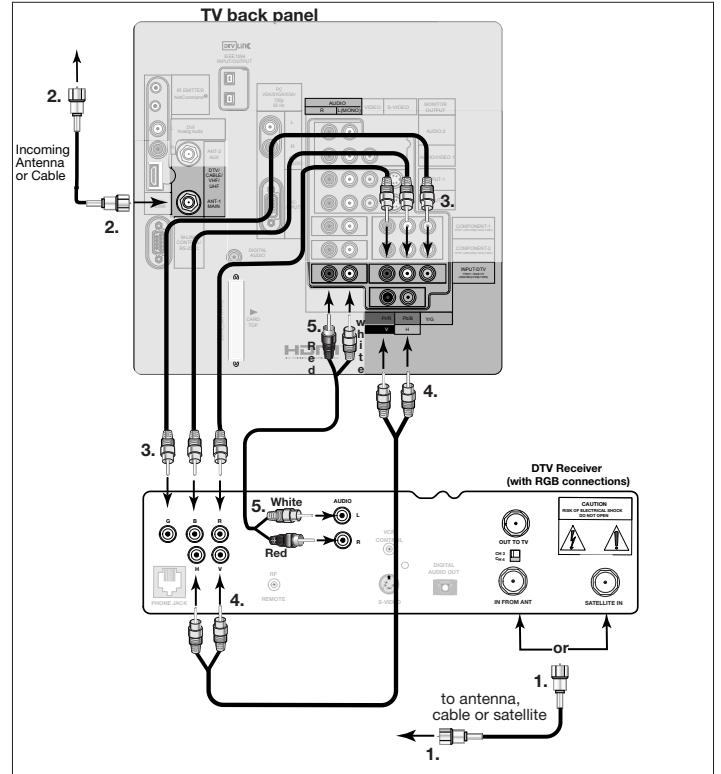

Figure 13. Connecting an External DTV Receiver with RGB Video Connections

It may be necessary to obtain a VGA to RGB, HV adaptor cable. These are available at most computer stores and many electronic stores. Some of the adaptor cables have RCA type connector ends, others have BNC type ends and will require adaptors as shown on page 26.

### IMPORTANT

See Appendix B for RGB, HV video signal compatibility information.

For digital audio connections, see your DTV Receiver and A/V receiver Owner's Guides.

# Connecting M-Link Control RS-232C Connection, or a HDMI or DVI Device

## M-Link Control RS-232C Connection

Figure 14

A 9 pin RS-232C cable is required. This is not included with the TV. It may be available at your local electronics retailer

When used as a M-Link Control, you can connect to a Mitsubishi HD Receiver/Controller, like the HD-5000 or HD-6000. When used as a RS-232C, you can connect to other external controllers. See mitsubishi-tv.com for RS-232C command protocol. Connect a 9 pin RS-232C cable from the TV back panel to the M-Link or RS-232C on the external control device.

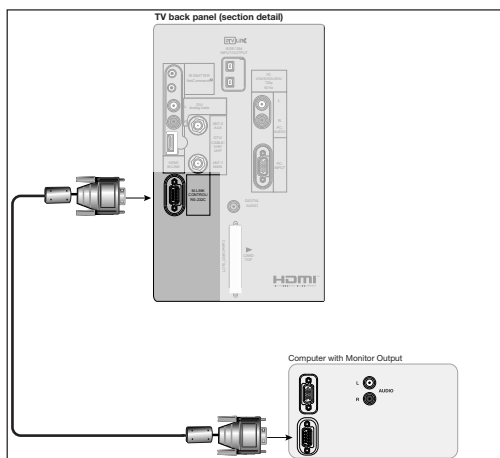

Figure 14. Connecting M-Link Control

## HDMI Device

Figure 15

An HDMI to HDMI cable is required. This is not included with the TV. It may be available at your local electronics retailer

Connect an HDMI cable from the TV back panel to the HDMI device output. HDMI devices provide video and audio through this cable, so no other connection is required.

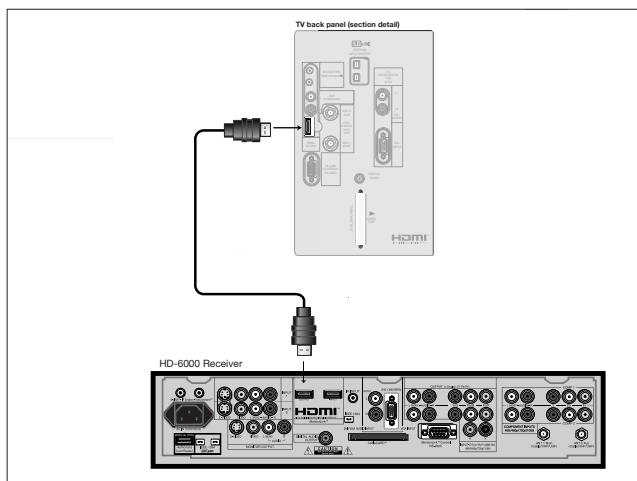

Figure 15. Connecting HDMI Device

## DVI Device

Figure 16

A DVI-to-HDMI cable or DVI/HDMI adaptor and HDMI cable and audio cables are required. These are not included with the TV. They may be available at your local electronics retailer.

1. Connect the DVI-to-HDMI cable (recommended) (or DVI/HDMI adaptor with an HDMI cable) from the DVI device's back panel to the TV back panel.

NOTE: If you are using a DVI/HDMI adaptor, it is important to connect the adaptor to the DVI side for best performance.

2. Connect a set of audio cables from AUDIO OUT on the the DVI device back panel to the DVI Analog Audio input on the TV back panel. The red cable connects to the R (right) channel, and the white cable connects to the L (left) channel.

NOTE: The HDMI connection supports copy protection (HDCP). Some devices require connecting to an analog input first, in order to view on-screen menus and select DVI as the output. Please review your equipment instructions for DVI connectivity and compatibility.

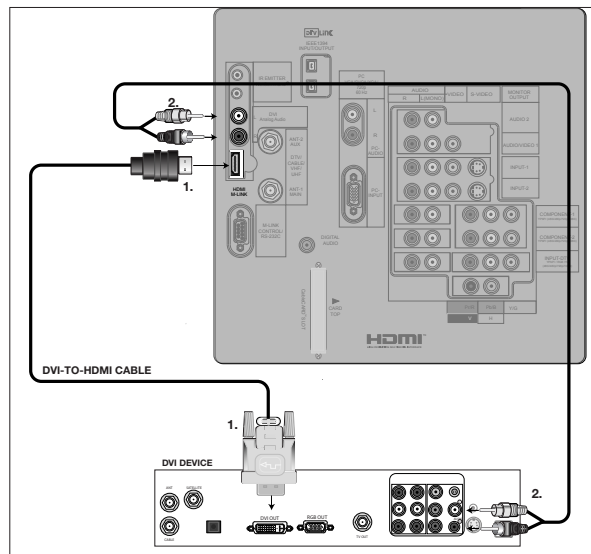

Figure 16. Connecting a DVI Device



**CAUTION:** To ensure continued FCC compliance, the user must use a shielded video interface or HDMI cable with bonded ferrite cores at both ends when using the PC input.

# Connecting the IR Emitter NetCommand®

## IR Emitter NetCommand®

Figure 17

A quadruple IR Emitter cable is included with the TV.

The emitters connected to these jacks are used by the NetCommand system to control other devices such as VCRs, DVD players, Cable boxes and Satellite receivers.

1. Connect the plug end of the supplied quadruple IR Emitter Cable to one of the IR Output NetCommand jacks on the TV back panel.
2. Run the cable for each of the emitter ends under, along side or over the top of each device to be controlled to the area of the front where the remote control sensor is located.
3. Place the emitter end in front of the remote control sensor of the device to be controlled. The emitter bulb should face the remote control sensor. This bulb emits infrared light in a cone shaped pattern. The bulb needs to be placed far enough from the remote control sensor to allow the cone pattern to include the sensor.

The remote control sensor is usually behind the plastic window of the front display panel. It is sometimes visible when you look through the display plastic using a flashlight and is normally a round or square cutout behind the plastic. If you cannot see the sensor and the device's Owner's Guide does not specify the location, you can find it by using the device's remote control. Hold the remote about 1/2 inch from the front of the device. Starting from one end of the display window plastic, press the POWER button.

If the device does not respond, move the remote control 1 inch toward the center and try again. Repeat this until the device responds. Note this location then start over from the other end of the display window plastic, repeating until the device responds again. The remote control sensor will be somewhere between these two positions. This is usually enough accuracy for the placement of the IR emitters.

4. With some devices, the emitter will work better facing downward from the top of the device. Some experimentation may be needed.
5. The emitter end being used can be secured in place using double stick tape.

6. If you are not going to be using all emitter ends, place the unused ends behind the devices so that they cannot send signals to the remote control sensors.

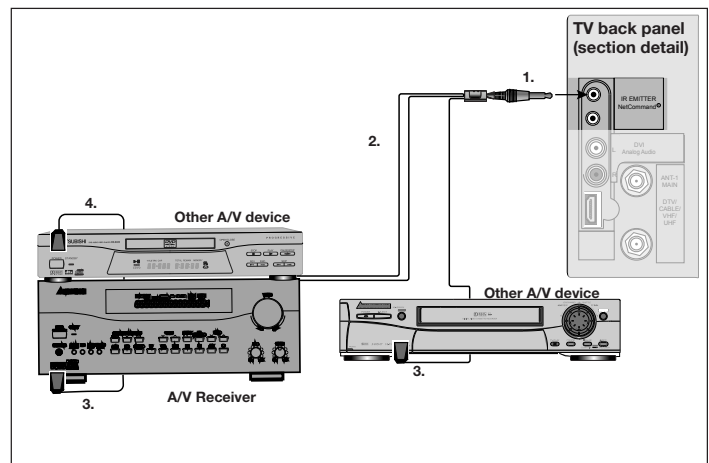

Figure 17. Connecting IR Emitter NetCommand

### IMPORTANT

If a single emitter end can be placed in a position that will operate more than one device, do not use a separate emitter end for the additional device. A single device receiving remote control signals from too many emitters or remote controls may not respond at all.

# Connecting Compatible IEEE 1394 Devices

## Compatible IEEE 1394 Devices

It is possible to connect devices to the TV that have IEEE 1394 connectors but are not compatible with the TV or with the NetCommand® control system. Areas of compatibility to consider are:

### 1. Digital Video Signals

The TV is able to decode MPEG2 video. Other types of digital video, such as DV video provided by some camcorders, must be decoded by the source device and sent to the TV as analog video or S-Video. If the camcorder uses a compatible digital control system, the IEEE 1394 cable can still provide control for the camcorder while the TV is viewing the analog video or S-Video signals.

### 2. Digital Audio Signals

When received with video signals, the TV is able to decode Dolby Digital signals and MPEG audio signals. Other types of digital audio as provided by some digital recording devices, such as MP3 audio and DTS audio, cannot be decoded by the TV when received over IEEE 1394.

The TV may not be able to pass incompatible digital audio signals on the coaxial digital audio output, however these signals may pass on the IEEE 1394 cable to other devices.

### 3. Digital Control Signal

The TV is able to act as the control center for IEEE 1394 audio/video devices, such as VCRs, A/V Discs, tuners, cable boxes and amplifiers that are compatible with the following IEEE 1394 control standards.

- **EIA-775** is designed for tuning devices such as cable boxes allowing the device to send simple graphics. However, this standard does not allow the TV to control the cable box by IEEE 1394.
- **AV/C (Audio Video Control)** is designed to provide basic controls such as play, stop, channel selection and volume, as appropriate for the device.

Some devices may be a combination of two or more types of devices. For example, there may be a recording device that is also a tuning device. Each portion of the device is called a sub-unit. When you select a device on the Device Selection menu that has sub-units, a pop-up menu will appear so you can select which sub-unit section you wish to use.

## When Connecting IEEE 1394 Devices

- Do not loop the last device in the chain back to the TV. When the device chain is looped, the TV may not be able to work with the other devices.
- Place devices that have only a mechanical (two-position) power switch at the end of the chain or leave the power switch in the On position. When turned Off, IEEE 1394 signals may not be able to pass through the device to other devices.
- Place devices with the slowest communication speed at the end of the chain. Sometimes the communication speed will be marked near the IEEE 1394 connector with an "S" number. The higher the number, the faster the communication speed. This TV has a communication speed of S400. Devices with slow communication speed can interfere with IEEE 1394 signals from faster devices. When using NetCommand to set up a digital recording between a faster and slower device, the slower device should be the source and the faster device should be the sync.
- Do not use an IEEE 1394 cable longer than 15 feet between each device.
- This TV is an IEEE 1394a Device. IEEE 1394b is currently under development. This system will provide for longer distances and multi-room applications. Included in the IEEE 1394b systems are IEEE 1394a to IEEE 1394b converters to maintain compatibility with this TV and other IEEE 1394a devices.

# Connecting Compatible IEEE 1394 Devices, continued

## Connection Styles

There are two different connection styles that can be used when connecting IEEE 1394 devices. Use the style that fits your network of audio/video products.

### Direct Device-To-Device Style

The IEEE 1394 offers you the capability to chain devices, unlike previous audio and video connections where you had to individually connect each device directly to the TV. For example, you can connect your D-VHS to your 1394 DVD Player and then connect the 1394 DVD Player to the TV. The resulting IEEE 1394 chain will allow you to add more devices to the chain. You will be able to see each video device on the TV's Device Selection Menu and send information from any IEEE 1394 device to other compatible devices.

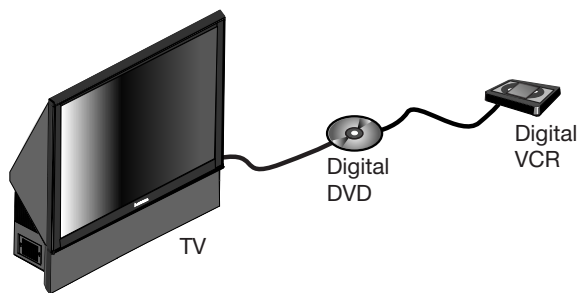

### Hub Connection Style

The IEEE 1394 also offers you the capability to connect your devices using the TV as a hub within the audio/video network. Each device can send information, which may include audio and video, to any other device in the network.

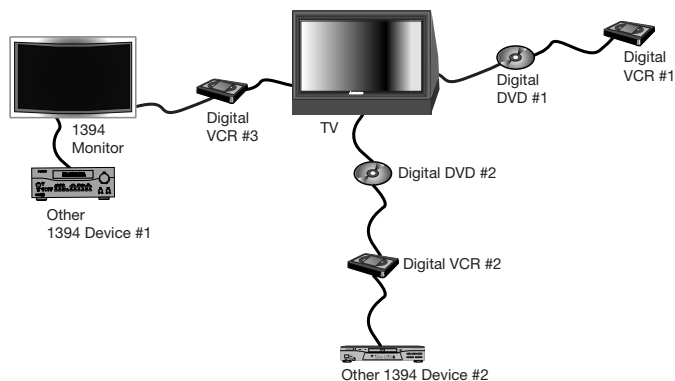

## 4-Pin Style vs. 6-Pin Style Connectors

There are two different types of connectors used for IEEE 1394 terminals and cables, a 4-pin and a 6-pin style.



4 pin connector

The 4-pin connector sends digital audio signals, digital video signals and digital control signals back and forth between devices. Your TV has three 4-pin type connection jacks available. One is on the front panel and two are on the back.



6 pin connector

The 6-pin connector is capable of sending the same digital audio, video and control signals as the 4-pin connector, but the 6-pin connector is also able to send low voltage electrical power. This TV does not have 6 pin connectors.

The purpose of this low voltage electrical power is to provide the needed operating power to a device that is not connected directly to the household AC power such as a camcorder. A device with a 6-pin connector can send this electrical power to another device, or receive electrical power from another device, or simply use a 6-pin connector without using the two additional pins.



6 pin to 4 pin adaptor

A 6-pin connector cannot be connected directly to a 4-pin jack, and vice versa. To connect a 6-pin device to a 4-pin device, you will need to obtain a 6-pin to 4-pin adaptor or adaptor cable. These cables are available from electronic and computer stores.

When connecting a 6-pin device (such as a camcorder) to the TV, (if it is designed to receive electrical power from another 6-pin device) you will need to connect the camcorder directly to the household AC, or use the camcorder's battery for power. If this is not possible, then the camcorder will need to be connected directly to another 6-pin device in the network that can provide the electrical power.

# Connecting: Helpful Hints

**Q My VCR (or other device) does not have two sets of stereo audio outputs. How can I connect this device's audio to both the TV and the A/V Receiver?**

A. There are two solutions:

1. Connect the single set of stereo audio outputs to the TV only. Use Edit NetCommand® to change the setup of this device. In the Connection screen of "Change" make sure both audio and video for the TV input are checkmarked and neither the audio or the video for the AVR input are check marked. This will allow the NetCommand system to use the TV outputs to transfer the device's audio to the A/V Receiver. See Edit NetCommand in the next chapter for details.
2. Use RCA type "Y" splitter cables to split the device's audio output to be connected to both the TV and the A/V Receiver.

**Q. I have both the TV monitor stereo audio output and TV digital audio output connected to the same input designation on my A/V Receiver. How do I switch between analog audio and digital audio?**

A. This depends on the individual A/V Receiver. Some A/V Receivers will switch automatically to digital when a digital audio signal is supplied. Other A/V Receivers can be manually switched by remote control. For these types of A/V Receivers, see Edit NetCommand in the next chapter for NetCommand control of these features. Some A/V Receivers will require that you make this change on the front panel of the A/V Receiver.

**Q. The front panel of my A/V Receiver is too tall or too convex for the IR emitter signal to reach the remote control sensor of the A/V Receiver. What can I do?**

A. There are several possible solutions.

1. Mount the IR Emitter on the top, front edge of the A/V Receiver over the remote control sensor. Use tape to secure it in place.
2. Mount the IR Emitter on the underside of the shelf above the A/V Receiver (if the A/V Receiver is in a cabinet). Use double sided tape to secure it in place.
3. Some small stick-on emitters from other manufacturers may be compatible with this TV's IR Emitter jacks. These may be used instead of the supplied IR Emitters.

**Q. I occasionally need to see the menu from my A/V Receiver. How can I connect it to the TV for this purpose?**

A. You can connect the video output of the A/V Receiver to an unused input on the TV. Then use Edit NetCommand to "Add" this as an "Other" device, not an A/V Receiver. On the "Connection" screen, indicate which TV input was used and checkmark the video box. Make sure the TV input audio box and both the audio and video boxes for the AVR input are not checkmarked. You should also name this device so you can easily identify it on the Device Selection Menu. You can also use Input 3 (Camcorder) on the front panel.

**Q. I have a high definition receiver I would like to connect and it also has an S-video output I would like to be able use as well. Is there any way to connect this receiver both ways?**

A. Yes, this item will appear twice in the Device Selection Menu. Just add this unit once using the Input-DTV and once using one of the S-video inputs. Make sure you indicate that this is the same manufacturer for both. We suggest that you connect stereo audio outputs with the S-video to the TV so that you do not need to use two inputs on the A/V Receiver. If this is a NetCommand compatible HDTV receiver and HD or SD outputs can be switched by remote control, see *Edit NetCommand* in the next chapter for NetCommand control of this feature.



## **NetCommand® Setup and Editing**

Using the Remote Control with NetCommand® .....	34
Remote Control Functions: Overview.....	35
Remote Control Functions:	
Operation .....	36
Care .....	36
Sleep Timer.....	36
NetCommand® OnScreen Buttons.....	37
3D Graphical Viewpoint® Menu System .....	38
NetCommand® Initial Setup.....	39
Edit NetCommand®	
Add an A/V Receiver.....	41
Add Devices.....	44
Change.....	48
Delete Devices .....	48
Finish Screen.....	48

# Using the Remote Control with NetCommand®

Below is a list of several manufacturers devices tested and shown to be compatible with NetCommand. These devices can be controlled without changing the setting of the remote control from TV to another product. NetCommand may be able to operate additional models since many manufacturers use the same control signals to operate some or all of the models they offer. This chart lists only the models that have been tested with NetCommand. The NetCommand Learning feature is able to learn the remote control signals of most Audio Video devices. For devices not listed in the table, or if your device does not operate using the same remote control as the models listed below, use the learning feature by selecting "Other" at the [Device] screen. See the *Edit NetCommand* section of this Guide.

**NOTE:** There are many different types of remotes and not all of them may be compatible with the learning feature. Bright light near the TV screen can also adversely affect the learning feature. If it is not possible to learn a device, you will need to use the original remote control of the device, or program the TV remote to operate these devices in the traditional manner.





## NetCommand Pre-Memorized Devices

		DEVICE				
		A/V receiver	Cable Box	DBS Satellite Receiver	DVD Player	VCR
M A N U F A C T U R E R	Mitsubishi	M-VR800, M-VR900		SR-HD5	DD-6000, DD-8020	HS-U795, HS-U778
	Bose	Lifestyle® 28			Lifestyle® 28	
	Denon	AVR-2700				
	Echostar			6000		
	Funai					F260LA
	General Instruments		CFT2200			
	Hitachi				DV-P415U	VT-FX665A
	Hughes			HIRD-E45, HIRD-E86		
	Integra	DTR-9.1			DPS-9.1	
	Jerrold		Not specified			
	JVC				XV-S65GD	HR-VP 650U
	Kenwood	VR2080				
	Marantz	SR8200				
	Microsoft				XBox™ (requires the DVD kit from Microsoft)	
	Motorola		DCT2244			
	Panasonic			TU-HDS20	DVD-A310	PV-8662
	Philips					VR620CAT
	Pioneer	VSX-D557, VSX-49TX			DV-414	
	RCA			DRD480RE, DTC-100		
	Rotel	RSX-1065				
Scientific Atlanta		8600				
Sharp					VC-H810U	
Sony	STR-DE825		SAT-A55	DVP-S500D, PlayStation® 2 (Playstation® 2 requires the DVD Remote Controller kit from Sony; DVD Player software disc version 2.10)	SLV-778HF	
Toshiba			DTS-3000	SD-9200, SD-5109	W-717	
Yamaha	RX-V2095, RX-V2200			DVD-S520, DVD-C996		
Zenith			DTV1080			

# Remote Control Functions: Overview

## Overview

Figure 1, following page

- 1. Slide Switch:** Selects A/V product to be controlled by the remote control. Select TV for NetCommand® device control.
- 2. Numbers:** Individually selects channels or enters information into menus.
- 3. POWER:** Turns power on and off for TV and other A/V products.
- 4. SQV (SuperQuickView™):** Scans through memorized lists of favorite channels.
- 5. QV (QuickView™):** Switches between the current channel and last channel viewed.
- 6. SUB/CANCEL:** Clears SQV and some menu entries and cancel recordings. For digital channels, adds separator between major and sub channel numbers.
- 7. DEVICE:** Displays the Device Selection menu to select the device to view (Ant-1 and Ant-2, TV Disc or devices connected to the TV's inputs including IEEE 1394 devices).
- 8. CHANNEL:** Scan up or down through memorized channels. Performs chapter skip function for NetCommand® controlled DVD's.
- 9. VOLUME:** Changes sound level.
- 10. MUTE:** Turns sound on or off.
- 11. TV MENU:** Displays  on-screen menu system.
- 12. ADJUST:** Press , ,  and  to navigate menus, change settings, and move the PIP on-screen location. Operates many NetCommand functions. Performs skip forward and backwards function of TV Pause.
- 13. ENTER:** Selects a channel number or menu item.
- 14. GUIDE:** Displays ChannelView™ for Ant-1 and 2. Displays Track List for TV Disc and IEEE 1394 A/V Discs. Displays program guide for satellite receiver, some cable boxes or DVD Disc menu. Displays thumbnails or playlists for media card files.
- 15. Light:** Located on the right side of the remote control, this feature illuminates buttons or labels.
- 16. DEVICE MENU:** Displays menus for devices connected to TV, including CableCARD™.
- 17. HOME:** Exits TV on-screen menus and returns to TV viewing.
- 18. V-CHIP:** Turns On or Off the V-Chip Lock.
- 19. INFO:** Displays on-screen summary of the current device used and any broadcast information available (including current V-Chip information). See Appendix D for details.
- 20. AUDIO:** Selects and adjusts individual audio settings.
- 21. VIDEO:** Selects and adjusts individual video settings.
- 22. PIP CH:** Scrolls up or down through memorized channels for PIP.
- 23. PIP/POP:** Cycles through PIP and POP display choices.
- 24. EXCH:** Exchanges PIP or POP and main TV picture.
- 25. SLEEP:** Sets the TV to turn off within 2 hours. See next page for setup instructions.
- 26. PIP DEVICE:** Displays PIP Selection menu to select the PIP or POP image source device
- 27. FORMAT:** Changes the shape and size of the main TV picture.
- 28. CONNECT:** Initiates IEEE 1394 peer-to-peer connections.
- 29. REC (Record):** Display the Record List for TV Disc. Records with a VCR, sets up recordings for DVCR, IEEE 1394 devices or while in ChannelView.
- 30. PAUSE:** Pause a live TV picture when no PIP or POP image is displayed (when TV Pause is set to Always or On Request is enabled). When PIP or POP image is visible, pauses that image (default TV Pause set to Off or On Request not enabled). Pauses a VCR, DVD or A/V Disc, media card file. Returns to TV viewing from TV Pause.
- 31. REW/REV:** Rewinds or reverses search in TV Pause, while watching the TV Disc or with a VCR. Reverses scan with a DVD, A/V Disc or media card file.
- 32. PLAY:** Plays the TV Disc or VCR, DVD, A/V Disc or media card file.
- 33. STOP:** Stops a VCR, DVD, TV Disc, A/V Disc or media card file.
- 34. FF/FWD:** Fast forward or forward search in TV Pause, while watching the TV Disc, with a VCR or media card file, or fast play a DVD.

# Remote Control Functions: Operation and Care, Sleep Timer

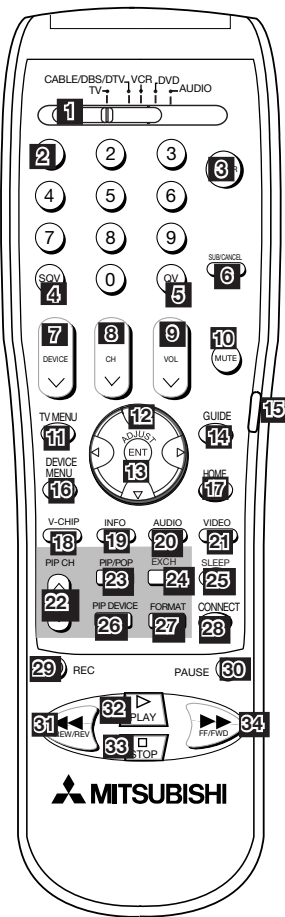

Figure 1. Remote Control Overview

## Operation

Figure 2

### Installing the Batteries:

1. Remove the remote control's back cover by gently pressing the ribbed tab in the direction of the arrow and sliding off the cover.
2. Load the batteries, making sure the polarities (+) and (-) are correct. For best results, insert the negative (-) side first.

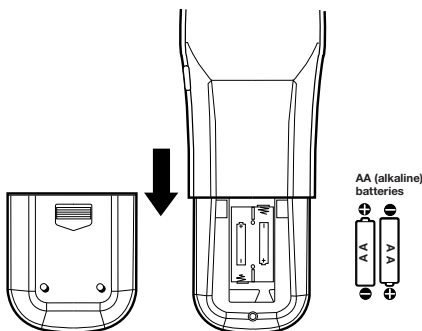

Figure 2. Operation: Installing the Batteries

## Care

### For Best Results from the Remote Control:

- Be within 20 feet of the equipment.
- Do not press two or more buttons at the same time unless instructed.
- Do not allow unit to get wet or become heated.
- Avoid dropping on hard surfaces.
- Do not use harsh chemicals to clean. Use only a soft, lightly moistened cloth.
- Do not mix new and old batteries.
- Do not heat, take apart or throw batteries into fire.
- Use only AA alkaline batteries.

*Hint: If the remote is in the TV layer and will not function, press POWER and 935 to reset the remote.*

## Sleep Timer

### Setting the Sleep Timer:

1. Press SLEEP on the remote control.
2. Each press of SLEEP increases the time displayed by 30 minutes, until the maximum value of 120 minutes is reached.
3. After 5 seconds of inactivity, the message will disappear.
4. Press SLEEP to view the remaining time before the timer turns the TV off.

### Canceling the Sleep Timer:

1. Press SLEEP to display the on-screen message.
2. Press SLEEP repeatedly until OFF is displayed.

**Note:** After 5 seconds of inactivity, the message box disappears.

# NetCommand® Setup On Screen Buttons

To use the TV's NetCommand feature, you need to provide some detailed information during the setup of your Mitsubishi TV. You must define the manufacturer of the devices that are connected to the television, or learn the IR code remote control signals for the device connected. For each device, the input to the TV and A/V receiver, and the names for the device are pre-set during Initial NetCommand setup. You may change those inputs or names using the Edit NetCommand or Learn screens. The buttons described below will help you navigate the screens.

On your remote control, the ADJUST ◀ and ▶ buttons allow you to navigate left and right to different selections on the screen. The ADJUST ▲ and ▼ buttons allow you to:

- Change the radio button
- Change current text box selection
- Navigate up and down on the screen

The ENTER button allows you to:

- Confirm the selected character when naming a device
- Add or delete check marks in check boxes
- Select on-screen buttons to change screens

## Textbox

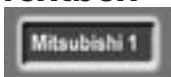

Press ADJUST ▲ or ▼ to make a selection.

## Checkbox



Checkmarks indicate the item or input is added or turned On. Press ENTER when the Checkbox is highlighted to add or delete a checkmark. When viewing the Review screen, a Checkbox reflects which devices are turned On or Off, or connected to the TV.

## Radio Buttons



The setting changes when one of the choices is highlighted.

## Control Buttons

Much like the software on your computer, you will use graphic buttons to navigate through the NetCommand Setup screen. Highlight the button and press ENTER to select the function.

### <Back Button



Use the <Back button to navigate back to the previous screen.

### Next> Button



Use the Next> button to navigate forward to the next screen.

### Cancel Button



The **Cancel** button will cancel out any changes you are currently making without saving them into memory. When you select the Cancel key, NetCommand will prompt you to confirm that you want to cancel the changes you are currently making. If you select Cancel during Initial Setup, you can setup NetCommand later by selecting the NetCommand menu, then choosing Initial.

# 3D Graphical ▶ViewPoint™ Menu System

Your TV also has Mitsubishi's exclusive 3D Graphical ▶ViewPoint™ on-screen operating system, which provides on-screen information for menu choices and changes, using the TV's remote control.

## ▶ViewPoint Menu Screens



A picture (icon) will be highlighted on the menu screen when selected with the ADJUST arrows. You may then make changes within the menu or access sub-menus, if available.



You can also access sub-menus from a button. Sometimes when you select a button, an automatic function begins.

The ▶ViewPoint™ system includes the following special features:

- The currently selected icon or button is highlighted with a yellow outline; the text color is yellow.
- On-screen instructions, shown in the message line at the bottom of the menu, provide feature selection and adjustment information.
- Some on-screen menu options must be set before other options are available.



*Main Menu: This screen will always be the first screen that appears when you press the remote's TV MENU button.*

## ▶ViewPoint™ Remote Control Buttons

The following buttons on your remote control help you navigate within the ▶ViewPoint™ system :

1. ADJUST ◀ or ▶ to select the menu item you want to change.
2. ADJUST ▲ or ▼ to change the settings.
3. ENTER to enter into a menu, start an automatic function or select a checkbox.
4. CANCEL to clear a setting or stop an automatic function.
5. TV MENU to display the main menu or move back one menu screen at a time.
6. HOME to exit all menus and return to TV viewing.

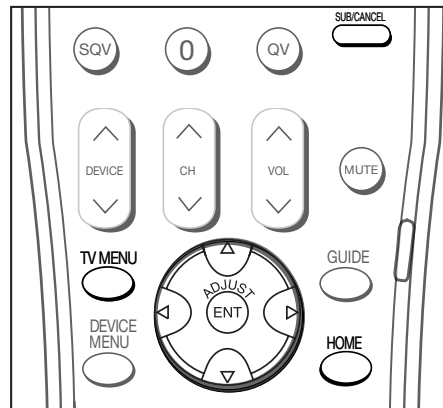

Press ADJUST ▲ or ▼ to change text boxes. Some text boxes have preset labels. Other boxes allow you to select letters, numbers or characters to customize names.

# NetCommand® Initial Setup

## IMPORTANT

You may use your TV without setting up NetCommand. You may also set up NetCommand at a later time by choosing the NetCommand menu from the Main menu, then selecting Initial.

## Welcome Screen

Figure 1

When you first turn on your TV, the Welcome screen displays and asks you to select either English or Spanish as the language for the on-screen menus. The default language is English. To change Language later, select Setup in the Main Menu. Selecting **Cancel** at this screen will cause the default language (English) to be selected.



Figure 1. Welcome screen

## NetCommand (Information) Screen

Figure 2

The NetCommand (Information) Screen describes how to start or delay the initial NetCommand Setup. This screen displays automatically the first time you power On your new TV after the Welcome screen. To setup NetCommand, select **Next>** and press ENTER.

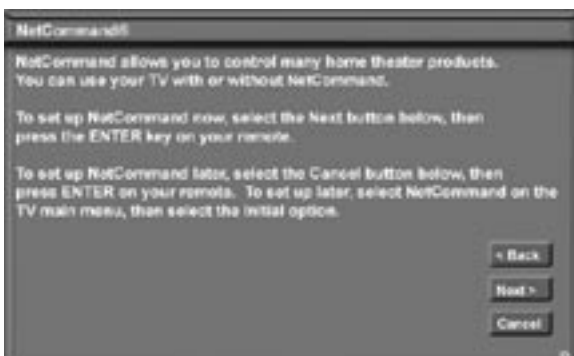

Figure 2. Information screen

If the NetCommand Setup is cancelled before it's completed, you can restart the NetCommand setup by:

1. A press of TV MENU on the remote control to display the TV Main menu.

2. Select NetCommand. The available options will be: Add, Review and Initial. Change and Delete will be grayed out.
3. Press ADJUST ▲, ▼, ◀ or ▶ to select Initial.
4. Press ENTER. The Device Setup screen displays.

## Device Setup Screen

Figure 3

If the devices connected to the TV are already in NetCommand memory, you can quickly select them at this screen. Press ADJUST ◀ or ▶ to move to each device type. Press ADJUST ▲ or ▼ to select the manufacturer. Select "Other" if the manufacturer is not listed. Later, you can use the Change setting in the Edit NetCommand menu to learn the remote control signals for this device. Select "None" for device types that are not connected.

For the A/V Receiver, if the manufacturer is not listed, you cannot select "Other". Instead, select "None". Later, you can use the "Add" feature in the NetCommand menu to have the TV add and learn the remote control signals for this device.

If you have a camcorder connected, check the Camcorder box. NetCommand will not be able to control it, but will reserve the front input to use with the camcorder. After completing your choices, select **Next>** and press ENTER.



Figure 3. Device Setup screen

# NetCommand® Initial Setup, continued

**Note:** If you selected “Other” for any of the device names, the TV can “Learn” the connected device by following the Edit NetCommand instructions. For many device types, non-listed models will operate in the same way as the listed models and you can still use the pre-loaded setting.

## Review Screen

Figure 4

After you have made your device choices the Review Screen will display. It is important to review the settings to ensure that they are correct. If necessary, you can use **<Back** to return to the Device Setup screen to make changes.

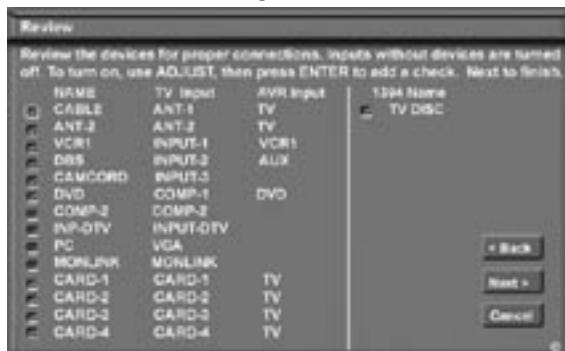

Figure 4. Review screen

**Note:** The Review screen lists the TV input and A/V receiver input used with each device. You must correctly identify the inputs you used when you connected the devices. If you have not connected your devices, write down these inputs as a guide. If you cannot use these inputs, or if you would like to change the name of a device, use the instructions in *Edit NetCommand* to make necessary changes.

**Note:** If you select **Next>** on the Review screen, all selections made are finalized.

On the Review screen, adding or deleting check marks will turn the adjacent devices, media cards or inputs On or Off. 1394 device names only appear on the Review screen when the devices are connected to the TV.

**Note:** If TV Disc is not checked, TV Pause will not be available.

## Finish Screen

Figure 5

To complete the NetCommand setup, select **Finish** from the Finish screen.

If you wish to change any of the pre-configured inputs or names for the devices, or add devices not in the pre-configured setup, select **Edit** to display Edit NetCommand menu.

If your A/V receiver was not listed, select **Edit** to add the AVR and then assign all devices to new AVR inputs.

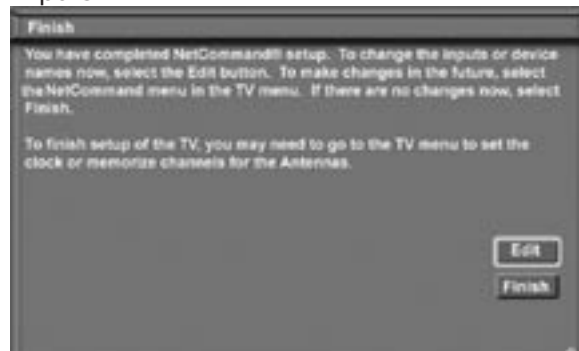

Figure 5. Finish screen

It is still necessary to memorize the available channels for Antenna-1 (and Antenna-2, if used). You may do that by going to the TV Main menu and selecting Antenna. Instructions to memorize channels are found in the *Antenna* menu section.



# Edit NetCommand®, Add an A/V Receiver

## A/V Receiver Screen

Figure 6

If your A/V Receiver manufacturer was not listed, and you selected “None” during the initial NetCommand Setup you may add the A/V Receiver and have NetCommand learn its remote controls functions. Either select Edit from the Finish screen or if you have finished the initial setup, go to the Main menu, select NetCommand, then press ENTER. The Edit NetCommand screen will display, select Add.

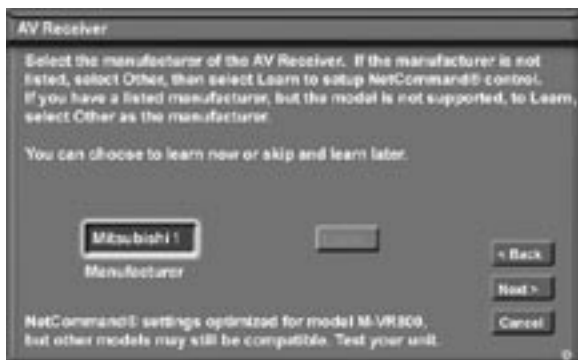

Figure 6. A/V receiver screen

Choose ONE of these options:

1. Select a recognized manufacturer. The model number optimized for NetCommand will display at the bottom of the screen. If a number follows the manufacturer’s name, (example: Mitsubishi 1), this indicates additional models are optimized for that manufacturer. For many device types, non-listed models will operate in the same way as the listed models and you can still use the pre-loaded setting.

After selecting **Next>**, the screens that follow are: the Name Screen (Figure 10), Monitor Out to AVR screen (Figure 11), ending with the Finish screen (Figure 12).

2. Select “Other”, then highlight “Learn” and press ENTER. This will allow you to have NetCommand learn the remote control signals of this new device.

After selecting “Learn” and pressing ENTER, the screens that follow are: the A/V receiver Inputs screen (Figure 7), A/V Receiver Input Learn screen (Figure 8), A/V Receiver Learn screen (Figure 9), Name screen (Figure 10), Monitor Out to AVR screen (Figure 11), ending with the Finish screen (Figure 12).

3. Select “Other”, skip Learn and select **Next>**. This will allow the device to appear and will allow NetCommand to switch inputs to use this device. However, NetCommand will not be able to control this device. Later you may use the “Change” option in the NetCommand menu to learn the remote control signals.

After selecting **Next>**, the screens that follow are: the A/V Receiver Input screen (Figure 7), Name screen (Figure 10), Monitor Out to AVR screen (Figure 11), ending with the Finish screen (Figure 12).

## A/V Receiver Inputs

Figure 7

If you select “Other” as the manufacturer, you will see the A/V Receiver Input screen after selecting “Learn” and pressing ENTER. After selecting the number of inputs, this screen will not appear again.

Depending on your A/V Receiver’s capability, you may connect up to to seven (7) A/V inputs. Select the number of inputs by pressing ADJUST ▲ or ▼.

If the number of connected inputs changes, you will need to delete the A/V receiver through Edit NetCommand and add it again, as described above.



Figure 7. A/V receiver Input screen

# Edit NetCommand®, Add an A/V Receiver, continued

## A/V Receiver Input Learn Screen

Figure 8

NetCommand can now learn the remote control signals used to select each input on the A/V receiver.

1. Press ADJUST ◀ or ▶ on the TV remote to select the check box for each function to be learned.
2. Press ENTER and the function name will begin to flash to confirm the ready-to-learn status.
3. Point the A/V receiver's remote control at the TV screen. Press the button on the remote control that corresponds to the selected function. A check mark will appear and the function name will stop flashing. This confirms the signal learned status.
4. To test the learned command, while the function is selected, press ENTER on the TV remote. The A/V receiver will perform the selected function. The A/V receiver needs to be turned on and the IR emitters properly placed for the test to be successful (see page 27 for IR emitter placement).
5. To customize the input names, press ADJUST ▶ to move to the Input Name text box and then press ADJUST ▲ or ▼ and ENTER to select each letter of the name. These names will appear on the Review screen as the A/V receiver's input names.
6. To erase the learned input signal, highlight the check box for that input and press CANCEL.
7. Repeat for each connected input.
8. When the input selection signals have been learned and the inputs named, press ADJUST ▶ to select **Next>** and move to the A/V receiver Learn screen.

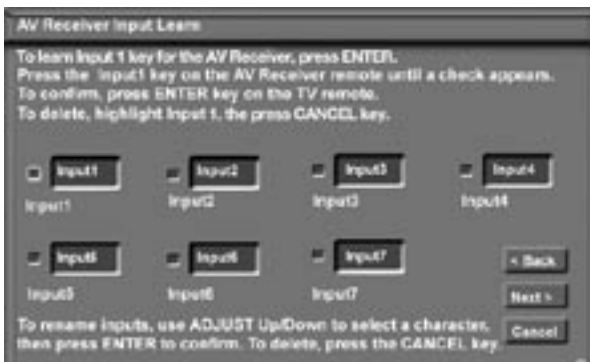

Figure 8. A/V receiver Input Learn screen

## A/V Receiver Learn Screen

Figure 9

1. Press ADJUST ◀ or ▶ on the TV remote to select the check box for each function to be learned.
2. Press ENTER and the function name will begin to flash to confirm the ready-to-learn status.
3. Press the button on the A/V receiver's remote control that corresponds to the selected function, A check mark will appear and the function name will stop flashing. This confirms the signal learned status.
4. To test the learned command, press ENTER on the TV remote. The A/V receiver will perform the selected function. The A/V receiver needs to be turned on and the IR emitters properly placed for the test to be successful (see page 27 for IR emitter placement).
5. Repeat for each function to be learned.
6. To erase a learned function, highlight the check box for that function and press CANCEL.
7. When the function signals have been learned, press ADJUST ▶ to select **Next>** and move to the Name screen.

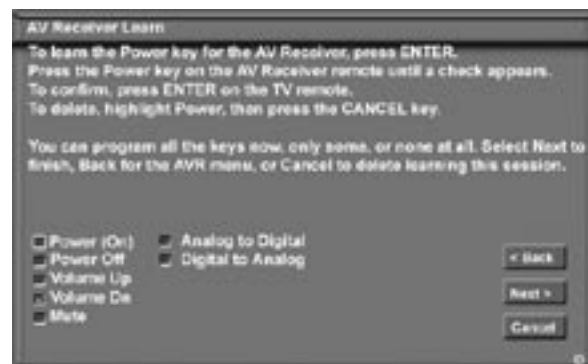

Figure 9. A/V receiver Learn screen

**Hint:** If your A/V receiver remote control uses a single button for both Power On and Power Off, don't learn the Power Off function. If your A/V receiver uses a single button to toggle between digital and analog sound, then learn only Analog to Digital. If your A/V receiver automatically switches between analog and digital audio, then you don't need to learn either Analog to Digital or Digital to Analog functions.

# Edit NetCommand®, Add an A/V Receiver, continued

## Name Screen

Figure 10

The Name screen allows you to change the default name for the A/V receiver to a custom name of up to eight characters (including a blank space), selecting from letters, numbers, and nine different characters. Using the TV's remote, press ADJUST ▲ or ▼ to select each letter, then press ENTER to move to the next position. Press CANCEL to delete the current letter and move back one character position. When in the first position, the CANCEL button will return the name to the default name.



Figure 10. Name screen

## Finish Screen

Figure 12

To finalize your selections and complete the A/V receiver setup, select **Finish** from the Finish screen.

**Note:** If you connected the audio output of a device directly to the A/V Receiver, you must use the "Change" function of the Edit NetCommand menu and select the device to assign the correct A/V Receiver input to be used with each device.

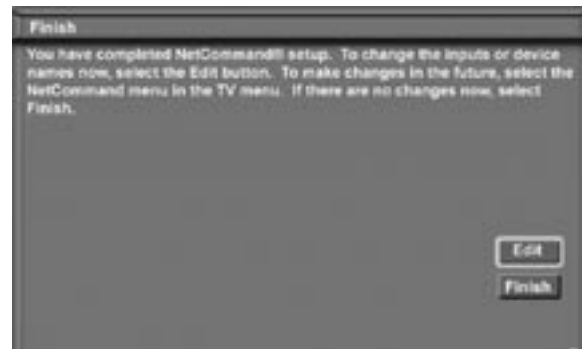

Figure 12. Finish screen

## Monitor Out to AVR Screen

Figure 11

Use this screen to select which A/V Receiver input is connected to Audio 2 Monitor Output on the TV back panel. Press ADJUST ► to select **Next>** and move to the Finish screen.



Figure 11. Monitor Out to AVR screen

# Edit NetCommand®, Add Devices

Mitsubishi's NetCommand allows you to edit your home theater configuration. You can add new devices, change device settings and connections, delete devices and learn remote control IR signals not already in NetCommand memory.

## Edit NetCommand Screen

Figure 13

If you selected Edit when you were at the Finish screen, the Edit NetCommand screen displays. The choices are:

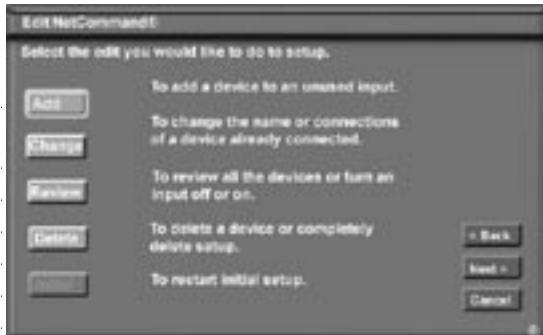

Figure 13. NetCommand Menu, Edit NetCommand Option

### **Add:**

Add a new device to the NetCommand setup. See Figure 14 for more information.

### **Change:**

Change the brand/model or input connections of a device already listed in the configuration. Learn the remote control signals of devices listed as "Other" brands. See Figure 24 for more information.

### **Review:**

View a list of all devices and input connections in the NetCommand home theater configuration. This is also where you can turn On or Off unused TV inputs or devices. See Figure 4 for more information.

### **Delete:**

Remove a device or erase the complete NetCommand home theater configuration. The learned remote control signals are erased when the associated device is deleted. See Figure 25 for more information.

### **Initial:**

Start the setup at the beginning. This button only becomes available after deleting the entire configuration, or if NetCommand was not set up when the TV was first powered On. If you select Initial, the first screen that will display is the Device Setup Screen. See Figure 3 for more information.

**Note:** If you have completed the NetCommand setup, you can access the Edit menu at any time by pressing TV menu, then selecting NetCommand. See page 67 for details.

Use these settings to change the NetCommand setup to reflect a change in your home theater system. To learn the remote control IR signals of a device that is not already in the NetCommand memory, add this device as manufacturer of "Other". The learning screens will then automatically be included in the series of screens used for adding the device.

## Add Screen

Figure 14

Select "Add" from the Edit NetCommand screen, and the New Device screen will display. Select the Device type that you would like to add. You may add your A/V receiver (if not added in Initial setup) Cable Box, Camcorder, DBS, DVD, Laser Disc, PC and VCR.

At the next screen, choose the manufacturer. If you choose "Other" for the manufacturer, the device (A/V receiver, Cable, DBS, DVD or VCR) can be learned. For device types Laser Disc, Camcorder, Game and PC, the "Learn" screen is skipped. There is no NetCommand support or learning for these devices.

At the next screen, you can keep the default Name or select a custom Name for the device, using ADJUST ▲ or ▼ to select letters A-Z, numbers 0-9, and/or symbols (!.&!/:\*- and blank) for each character of the name you would like for the selected channel.

The next screen displays the Connection screen (RF Connection for Cable, Figure 21). Select the TV and A/V receiver inputs that the device is connected to. Connecting only audio to the A/V receiver is recommended. The A/V receiver may need configuring for digital audio.



Figure 14. Add screen

# Edit NetCommand® Add Devices, continued

## [Device] Screen

Figure 15

If you selected “None”, during initial setup, then you can add a device. If you have added a new device, use this screen to start learning.

Our examples show the choices for adding a VCR, however, the same type of screens will appear for any DBS (Direct Broadcast Satellite), DVD player or Cable Box.



Figure 15. [Device] screen

Choose ONE of these options:

1. Select a recognized manufacturer. The model number optimized for NetCommand will display at the bottom of the screen. If a number follows the manufacturer’s name, (example: Mitsubishi 1), this indicates additional models are optimized for that manufacturer. For many device types, non-listed models will operate in the same way as the listed models and you can still use the pre-loaded setting.

After selecting **Next>**, the screens that follow are: the Name Screen (Figure 18), Connection screen (Figure 19) and specialized device screens (Figures 20-23), ending with the Finish screen (Figure 26).

2. Select “Other”, then highlight “Learn” and press ENTER. This will allow you to have NetCommand learn the remote control signals of this new device.

After selecting “Learn” and pressing ENTER, the screens that follow are: [Device] Learn screen (Figure 16), [Device] Advanced Learn screen (Figure 17), Name screen (Figure 18), Connection screen, (Figure 19) and specialized device screens (Figures 20-23), ending with the Finish screen (Figure 26).

3. Select “Other”, skip Learn and select **Next>**. This will allow the device to appear and will allow NetCommand to switch inputs to use this device. However, NetCommand will not be able to control this device. Later you may use the “Change” option in the Setup menu to learn the remote control signals.

After selecting **Next>**, the screens that follow are: the Name Screen (Figure 18), Connection screen (Figure 19) and specialized device screens (Figures 20-23), ending with the Finish screen (Figure 26).

## [Device] Learn Screen

Figure 16

Shown only if “Learn” was selected

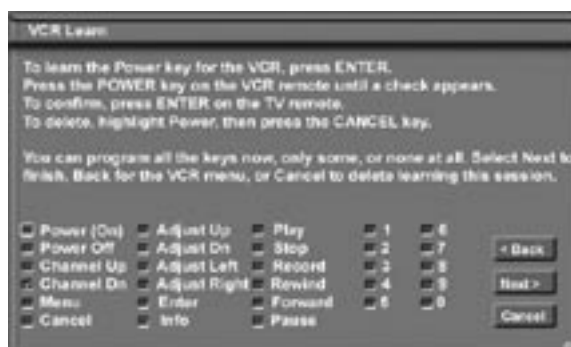

Figure 16. [Device] Learn screen

1. Press ADJUST ▲, ▼, ◀ or ▶ to select the check box for each function to be learned.
2. Press ENTER and the function name will begin to flash to confirm the ready-to-learn status.
3. Press the button on the device’s remote control that corresponds to the selected function. A check mark will appear and the function name will stop flashing. This confirms the signal learned status.

# Edit NetCommand®, Add Devices, continued

4. To test the learned command, press the ENTER button on the TV remote while the learned function is still highlighted. The device should perform the selected function. The device needs to be turned on and the IR emitters properly placed for the test to be successful (see page 29 for IR emitter placement). If the functions are not learned the first time, try Learn again.
5. Repeat for each function to be learned.
6. To erase a learned function, highlight the check box for that function and press CANCEL.
7. When the function signals have been learned, press ADJUST ► to select **Next>** and move to the [Device] Advanced Learn screen. NOTE: When learning the device's remote control signals, point the device's remote control at the TV screen.

**Hint:** If the device's remote control uses a single button for both Power On and Power Off, don't learn the Power Off function.

## [Device] Advanced Learn Screen

Figure 17

After learning the basic device keys, the [Device] Advanced Learn screen allows you to learn any special keys for your device. Most common IR remote control signal formats can be learned by NetCommand.

A table of specialized device keys is shown in Appendix E. You only need to learn the functions your devices respond to and can ignore the functions that do not apply to your device.



Figure 17 [Device] Advanced Learn screen

## Name Screen

Figure 18

The Name screen allows you to change the default name for each device to a custom name of up to eight characters (including a blank space), selecting from letters, numbers and nine different characters. Press ADJUST ▲ or ▼ to select each letter, then press ENTER to move to the next position. Press CANCEL on the remote to delete the current letter and move back one character position. When in the first position, the CANCEL button will return the name to the default name.



Figure 18. Name screen

## Connection for [Device] Screen

Figure 19

This screen allows the TV to learn the connection between device(s) and input(s). Inputs 1-3, Components 1 & 2, Input-DTV, VGA and/or the inputs for the A/V Receiver all need to be checked, if connected. Add or remove check marks to indicate what type of connections (Audio, Video or both) are used with each TV and A/V Receiver input.

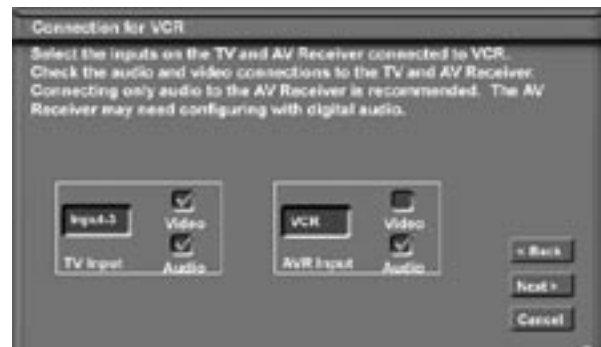

Figure 19. Connection for [Device] screen

# Edit NetCommand®, Add Devices, continued

The screens described below may not be necessary for your device setup. If they do not display automatically on-screen, they are not required.

## VCR for Recordings Screen

Figure 20

Select the VCR to use for recording. You may also select whether you want the recorded 16:9 signals from digital channels or IEEE-1394 devices to be cropped (sides are cut off) or Anamorphic (full screen). If Anamorphic is selected for viewing, choose the Standard format for the best quality playback.

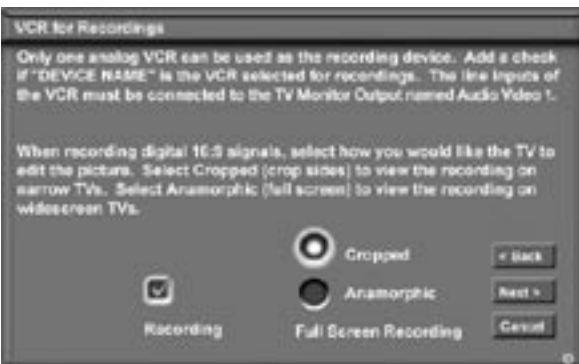

Figure 20. VCR for Recordings screen

## RF Connection for Cable Screen

Figure 21

The RF Connection screen displays only when adding or changing a Cable Box. If your Cable Box is connected to a TV Antenna input, check the RF checkbox. Select the TV antenna input that is used with the Cable Box. Select the channel number used for output by your cable box. The default channel is 003. If the Cable Box is also connected to a VCR for recording, select that VCR.

If your Cable box is connected using Audio/Video cables, make sure the RF checkbox is unchecked. Then the next screen will be Connection (Figure 19), to allow the selection of the TV input used with the Cable Box.

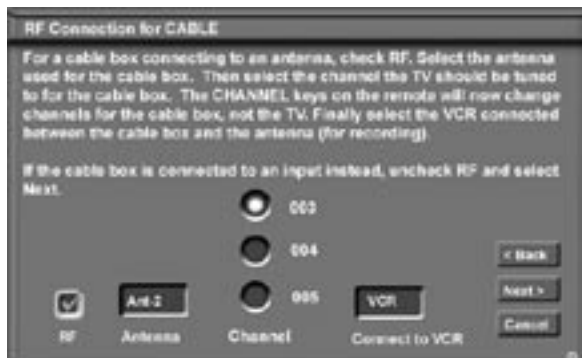

Figure 21. RF Connection for Cable screen

## Input-DTV Connection Screen

Figure 22

This screen displays only if the device selected in the Connection screen (Figure 19) is connected to Input-DTV. This is usually DBS, but can be Cable Box. The Input-DTV Connection screen allows you to select the connection type, RGB (HV) or Component YPbPr you are using to connect your cable box or DBS.

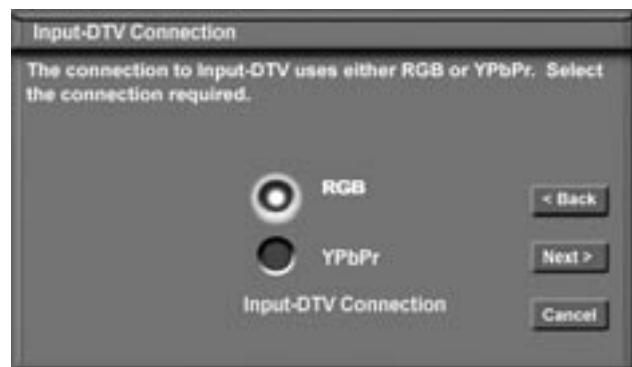

Figure 22. Input-DTV Connection screen

## IR Code for [Device] Screen

Figure 23

This screen only displays if an added device has the same IR code as a previously added device of the same type and manufacturer. You can specify the IR setting for the new device. For example, for the second Mitsubishi VCR you can specify the IR Code setting to VCR-B, if the primary Mitsubishi VCR is using the VCR-A IR code.

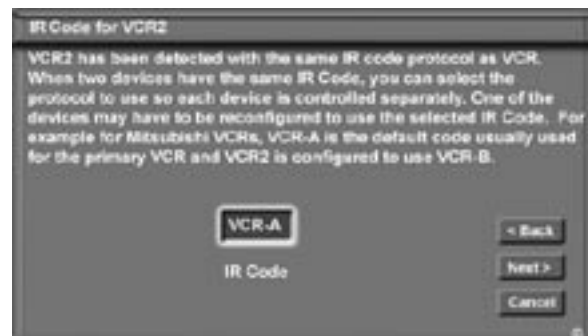

Figure 23. IR Code for [Device] screen

# Edit NetCommand®, Change or Delete Devices, Finish Screen

## Change Device Screen

Figure 24

Selecting Change from the Setup menu screen, displays the Change screen. To change a device, select the device by name, not type. You can change the name or input connections to the TV and A/V receiver. If “Other” is selected for the manufacturer then you can also “Learn”. The rest of the screens that follow are the same as when you Add a device.



Figure 24. Change screen

## Delete Device Screen

Figure 25

Selecting Delete from the Setup menu, displays the Delete screen. You can choose to delete a single device by selecting the device you would like to delete, or you can delete the entire NetCommand configuration. After you have chosen the device, or the entire configuration, you will be prompted to confirm your choice to delete. If you select the Entire Configuration, the Initial button becomes available on the Edit NetCommand screen. If you delete a device that you learned the remote control signals for the learned signals are erased.



Figure 25. Delete screen

## Finish Screen

Figure 26

To finalize your selections and complete the NetCommand setup, select **Finish** from the Finish screen.

**Note:** To change any of the inputs or names for the devices, or add devices not included in the initial settings, select Edit to display the Edit NetCommand menu.



Figure 26. Finish screen

### **IMPORTANT**

**NetCommand does not allow you to delete a device or change the connections for a device (like a VCR or a DVD player) if the device (input) is currently being displayed by the TV.**

**Switch the TV to a different device from the one you are changing or deleting. To change the A/V receiver, you need to be listening to the TV speakers.**



## **IEEE 1394 Devices and NetCommand® Controlled Recordings**

<b>IEEE 1394 Devices and NetCommand® Control .....</b>	<b>50</b>
<b>Adding IEEE 1394 Devices Automatically.....</b>	<b>51</b>
<b>Device Selection Menu.....</b>	<b>53</b>
<b>Using the DEVICE MENU Button to Display Menus.....</b>	<b>54</b>
<b>Using the Guide Button to Display ChannelView™ and Menus..</b>	<b>55</b>
<b>NetCommand® Controlled</b>	
<b>Recordings .....</b>	<b>56</b>
<b>Record List .....</b>	<b>56</b>
<b>Peer-to-Peer Connections .....</b>	<b>57</b>
<b>Using TV Disc &amp; A/V Disc .....</b>	<b>58</b>
<b>Direct VCR Recording from an Antenna or Cable Source.....</b>	<b>59</b>
<b>PC Viewing.....</b>	<b>60</b>
<b>MediaCommand™ and Media Card Playback .....</b>	<b>61</b>

# IEEE 1394 Devices and NetCommand® Control

See pages 30-31 for information regarding compatible IEEE 1394 devices and connection styles. The TV is not able to control IEEE 1394 devices that use other types of control protocols. Incompatible digital audio, video and/or control information will still be able to pass from one device through the TV to another device on the network. These incompatible devices may not appear on the Device Selection menu or in the Review screen of the Edit NetCommand menu.

## NetCommand Control of Digital Devices Using the “Learn” Feature.

Some IEEE 1394 devices such as cable boxes or satellite receivers will not have compatible digital control signals or require the use of the device’s own remote control. Some of these IEEE 1394 devices will not display on-screen information through the IEEE 1394 connection and will require using an analog connection for on-screen displays. In many cases, to control these digital devices, the Learning feature of NetCommand can be used.

1. Place an IR Emitter for NetCommand in front of the device’s remote control sensor (see IR Emitters, page 29).
2. On the Name for 1394 Device screen (Figure 2, page 51) use ADJUST and ENTER to check mark the Analog Connection box.
3. Select the device type on the IEEE 1394 Device Type screen (Figure 3, page 52) of DBS or similar tuning device.
4. If desired, using the ADJUST buttons enter a custom Name on the Name screen (Figure 18, page 46).
5. At the Device screen, Select “Other” as a manufacturer and then highlight “Learn” and press Next (Figure 4, page 52).
6. Follow the device learning instructions found on the screen(s) or in the Edit NetCommand section of Chapter 3.
7. The Connection screen (Figure 5, page 52) follows the learning screens. If analog connections are used, select the correct inputs.
8. Proceed with the Finish screen.

This will allow NetCommand to use the learned remote control signal to control these IEEE 1394 devices.

**Note:** When using the NetCommand learning feature for IEEE 1394 devices that do not have analog connections, the GUIDE function will require pressing GUIDE twice. The first press of GUIDE will display the TV’s digital channel guide. The second press will display the program guide for the device if an IEEE 1394 Guide is available.

# Adding IEEE 1394 Devices Automatically

## Adding IEEE 1394 Devices Automatically

When an IEEE 1394 device is connected into the TV network and is powered On, the new device will automatically announce its presence. This process is called device discovery and can take up to 1 minute. Some non-audio/video or non-compatible IEEE 1394 devices, such as Personal Computers (PCs), may not announce their presence to the TV. The TV will not be able to show these devices in the Device Selection menu, however, they can coexist and will still be available to other devices on the IEEE 1394 network that are compatible with these non-audio/video devices.

IEEE 1394 cable boxes and satellite receivers may require that you use the remote control that came with those devices. For some compatible devices, the Cable/DBS/DTV position of the TV remote control may be able to control operation.

## New 1394 Device Screen

Figure 1

When your TV discovers a new IEEE 1394 device, the New 1394 Device screen will appear. Selecting "Add" will include the device in the Device Selection menu. Selecting "Do Not Add" will not add the device to the Device Selection menu. If the IEEE 1394 device does not provide audio and video, you may not want to add that device to the TV's Device Selection menu. Devices that were discovered but not added to the Device Selection menu will still be listed in the Review screen of the Edit NetCommand® menu.



Figure 1. New 1394 Device screen

## Name for 1394 Device Screen

Figure 2

If you choose to add the discovered IEEE 1394 device, the Name for 1394 Device screen will appear. Name the device or use the default name that appears automatically.

Some IEEE 1394 digital devices, such as some DVCRs, can also operate as analog devices. For example, some DVCRs can record and play as VHS or S-VHS, in addition to D-VHS. This allows you to play analog rental tapes or analog tapes from your established library or make analog recordings from antenna or cable systems. To use the analog capability, check the Analog Connection box.



Figure 2. Name for 1394 Device screen

# Adding IEEE 1394 Devices Automatically, continued

## IEEE 1394 Device Type Screen

Figures 3 and 4

If the new IEEE 1394 device is also connected using analog inputs, you will need to define the device type. Select the type of device, such as a VCR.



Figure 3. IEEE 1394 Device Type screen

Once the device type is selected, then the Device screen is displayed so the manufacturer can be selected. If the manufacturer is listed, then you may be able to control this device while it is operating as an analog VCR. For example, if the IEEE 1394 device you have added is a Mitsubishi DVCR, and you have selected an analog connection as a second connection, then you will select Mitsubishi for the manufacturer. If the manufacturer is not listed, select "Other" and use the Learn screens.

Be sure to place an IR Emitter in front of the remote control sensor, just as you have done for other NetCommand® devices. It is necessary to use the IR Emitter only when the DVCR is being used as an S-VHS or VHS VCR. When the DVCR is playing or recording digital signals in D-VHS, the TV will control the VCR through the IEEE 1394 cable.

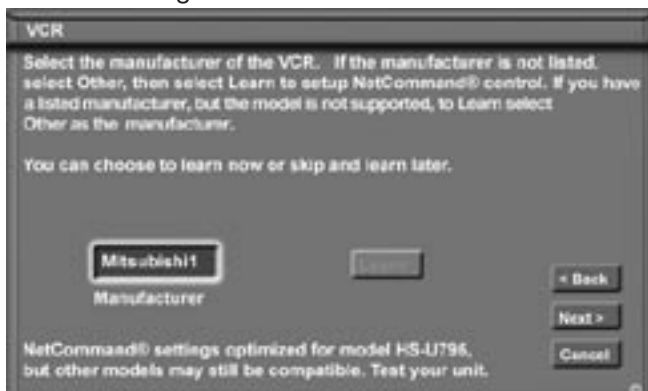

Figure 4. Device screen

## Connection Screen

Figure 5

Select the TV input that you used when you connected the video or S-Video cables. You may also select the TV or A/V receiver input you used when you connected the stereo audio cables. The TV will learn the input names for the TV Input and A/V Receiver Input selections. If your A/V receiver has other inputs than those listed in the menu, those other inputs are not available for NetCommand.

The playback and record control of some DV camcorders may still operate by the IEEE 1394 cable automatically, even though you must use the video or S-video cable for the picture. In this case, when you select the Camcorder, be sure to select analog (not digital) from the pop up when a camcorder is selected from the Device Selection menu. Then the picture is shown via the analog connection but control is from IEEE 1394.



Figure 5. Connection screen

## Finish Screen

Figure 6

To finalize your selections and complete the NetCommand setup, select **Finish** from the Finish screen.



Figure 6. Finish screen

# Device Selection Menu

When you press DEVICE on the TV's remote control, the Device Selection menu (Figure 7) displays. If NetCommand® has not been setup, the Device Selection menu allows you to select an input for viewing. If NetCommand is setup, the Device Selection menu allows you to select the device for viewing, select audio from the TV speakers or A/V receiver, power compatible devices On or Off, and verify the destination of signals. On the Device Selection menu, the device or input currently displayed appears as a gold-colored icon.

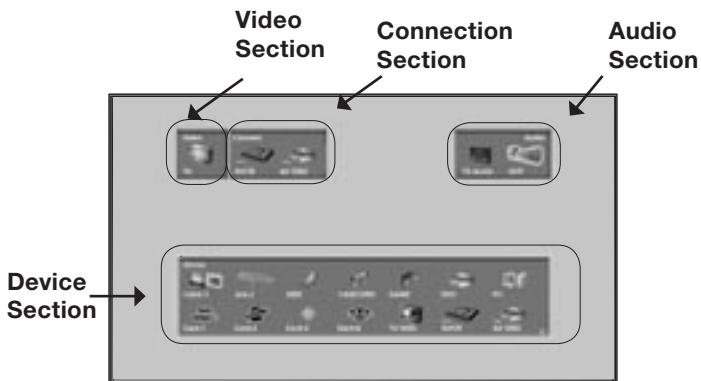

Figure 7. Device Selection Menu with NetCommand

## Power On/Off Devices

Devices that have separate On and Off remote control buttons will power On automatically when you select the device and will power Off when you turn off the TV. For devices that do not power On or Off automatically, display the Device Selection menu, press ADJUST ◀ or ▶ to highlight the device icon and press POWER on the remote control. For the A/V receiver, press AUDIO to move the navigation to the Audio Section. Highlight the A/V receiver icon and press POWER. If you press POWER on the remote control when the Device Selection menu is not displayed, the TV will turn Off.

## Device Section

To select another device or input, press ADJUST ◀, ▶, ▲ or ▼ on the TV's remote to move the highlight. Press ENTER to select the device to view and hear. The TV inputs are automatically changed. If NetCommand is set up, the inputs on compatible A/V receivers are automatically changed at the same time.

## Video Section

The destination of the device highlighted in the Device Section is displayed here as a TV icon.

## Connection Section

The Connection Section shows the other devices currently connected to the device highlighted in the Device Section. For example, if the Digital VCR (D-VCR) is currently recording, when you move the highlight to the Ant-1 icon, the D-VCR icon will appear in the Connection Section. This icon will disappear when you move the highlight to another icon, press CANCEL to stop recording.

## Audio Section

When a NetCommand pre-memorized or learned IR controlled A/V receiver has been connected to the TV and added to NetCommand Setup, an AVR icon will appear in the audio section. Press AUDIO to change navigation to the audio section. Then press ADJUST ◀, ▶, ▲ or ▼ to select the TV speakers icon or the A/V receiver icon. Press ENTER to change the audio selection. Press DEVICE to return the navigation to the Device Section.

## PIP Device Selection Menu

Figure 8

The PIP Selection menu displays when you press the PIP DEVICE button on the remote control. This menu has the same general format as the Device Selection menu. The source for the Video Section is the sub picture and the Audio and Connection Sections are not available.

Use ADJUST ◀, ▶, ▲ or ▼ to move the highlight to the device to show in the PIP or POP screen, then press ENTER. Device icons that are grayed out are not available for use as PIP/POP sources or with the current source.

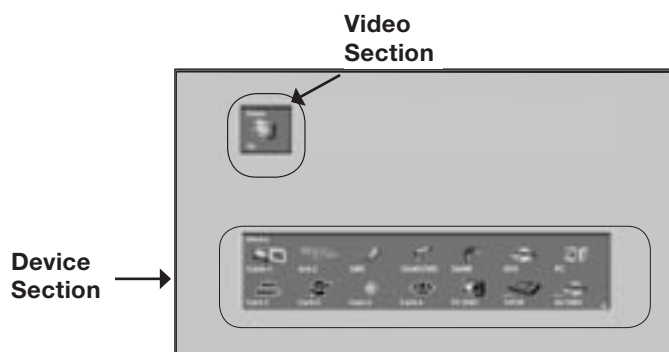

Figure 8. PIP Device Selection Menu

## IMPORTANT

If a device does not respond to separate On or Off remote control signals, the manufacturer has not provided that ability for the device.

# Using the Device Menu Button to Display Menus

## Device Menu

If NetCommand is setup, pressing the remote control's DEVICE MENU button displays the transport menu of the current device if the input is a VCR or DVD. Another press of the DEVICE MENU button will display menu for the current device source, if available.



Figure 9. Transport menu

## IR Controlled Devices

For a NetCommand compatible traditional IR controlled device, pressing DEVICE MENU once or twice will display the menu for that device. While the menu for the device is displayed, press ADJUST ◀▶, ▲ or ▼ and ENTER to navigate the screen. For some NetCommand traditional devices you will also be able to use the number buttons and other additional buttons on the TV remote.

For traditional DVD players, DEVICE MENU is also known as the setup menu.

## CableCARD™ Menu

Figure 10

When using a CableCARD, pressing DEVICE MENU will display a list of up to 8 links to applications that contain basic CableCARD information made available from your cable provider. Press ADJUST ▲ or ▼ to move through the application links. To select a link (blue text) to an application, press ADJUST ▲ or ▼ to highlight the link, then press ENTER to access the linked page. Pressing DEVICE MENU will return to the CableCARD menu screen and pressing HOME will return to TV viewing.

If there are technical problems with the CableCARD, an error screen will automatically display with information that may be needed by your Cable provider when you call them for assistance. The screen shown below is an example of the type of screen that may display. Specific screen menus are sent by your cable provider.

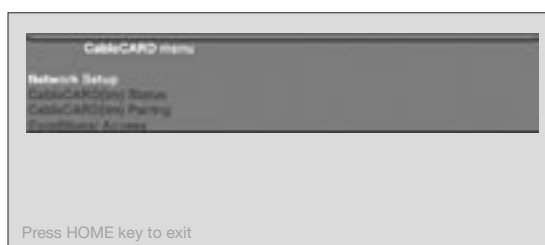

Figure 10. Possible Device Menu for CableCARD

## Moving Through Other CableCARD Screens

In addition to CableCARD menus, other CableCARD application screens may display and require you to make additional selections. While CableCARD application screens are customized in each area, some general rules apply in using these screens on your Mitsubishi television.

1. Blue text denotes a link to another screen. Press ENTER to move to the next application. When screens do not have blue text, there are no more links.
2. You cannot move backward through the links. If you want to exit the CableCARD system, press HOME to exit and return to TV viewing. CANCEL may not work with some CableCARD screens.

All information on these application screens is provided by your local cable company. Please contact your cable provider if you have any problems with the application screen displays.

### **IMPORTANT**

**Most CableCARD screens are status or diagnostic in nature and do not allow you to make changes. These screens are meaningful only to your local cable provider.**

# Using the GUIDE Button to Display ChannelView™ and Menus

## GUIDE and Devices (1394 or IR Controlled)

For NetCommand compatible satellite receivers and some cable boxes, GUIDE will display the on-screen programming guide for the receiver or cable box. Press ADJUST ◀, ▶, ▲ or ▼ and ENTER to navigate the displayed Guide. For NetCommand compatible satellite receivers, you may also be able to use the number or other additional buttons.

For NetCommand compatible DVD players, GUIDE will display the DVD disc “top” menu (not the setup menu). For A/V Discs, pressing GUIDE will display the Track List screen. For IEEE 1394 devices with digital connections, press GUIDE twice to display the device’s Guide. For media cards, pressing GUIDE displays a JPEG thumbnail menu (video) or a Playlist menu (audio).

## GUIDE and the Device Selection Menu

For compatible traditional VCRs, pressing GUIDE when the VCR is highlighted on the Device Selection menu will change the VCR’s input.

When the A/V Receiver icon is highlighted in the Audio Section, pressing GUIDE switches the A/V Receiver from analog audio to digital audio and vice versa.

## GUIDE and the Record To Menu

When in the Record To menu, pressing GUIDE will display the current list of programmed recordings. Please see Record List, *page 57* for more information.

## GUIDE and ChannelView

*Figures 11 and 12*

Press GUIDE while viewing Ant-1 or Ant-2 to display a list of available memorized digital channels (D) and analog (A) channel information (if available from the broadcaster). This list is called ChannelView™.

ChannelView for digital channels will show the major and sub-channels (or bitstreams). Analog channel information will display as sent. Press ADJUST ▲ or ▼ to scan through the all the channels in memory one by one. To cycle through the choices quickly, press CH ▲ or ▼.

For detailed program information, press ADJUST ▶, to return to basic information press ADJUST ◀. This information is sent by the broadcaster. If limited data is shown or no program data appears, it is because the broadcaster is not sending the information. *This is not a defect of your TV.*

## Recording a Current Program

To record a current program, press REC (record) when your program choice is highlighted on the program list in ChannelView. A red “R” will be added after the input name. The TV will immediately switch to the selected channel and start recording.

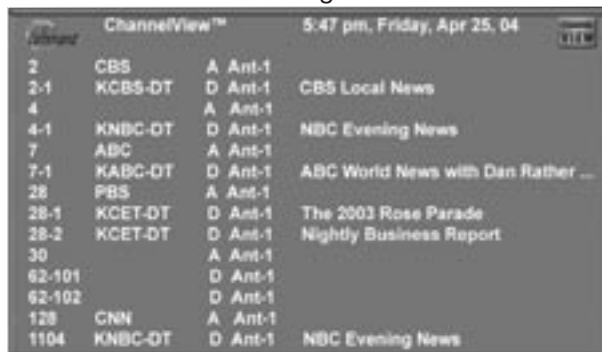

Figure 11. ChannelView screen, current programs

## Recording Future Programs

To record a future program, press ADJUST ▲ or ▼ to select the channel you want to record from. For detailed program information, press ADJUST ▶, to return to basic information press ADJUST ◀. Press REC (record) when your choice is highlighted. A red “R” will be added after the input name. The message, *The recording has been added to the Record List* will display. To view, change or cancel a recording, use the Record List (*page 57*). If a program title was not sent by the broadcaster, you will be unable to set up a recording and a message will display.

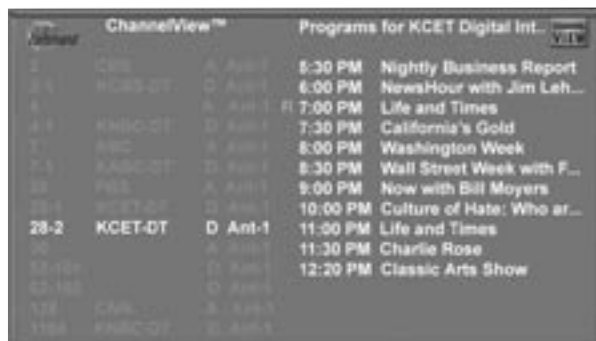

Figure 12. ChannelView screen, future programs

## IMPORTANT

For complete ChannelView information to be refreshed daily, the TV must be powered Off between 5 to 15 minutes a day, depending on the number of channels in memory. If the TV loses power, the program listings will be temporarily lost.

# NetCommand® Controlled Recordings

## Setting up Recordings

Figure 13

Through NetCommand, you can automatically start and stop recordings and send signals from one playback device to a recording device. Recordings can be made on recordable devices connected to the TV or to the internal TV Disc. The TV Disc is an IEEE 1394 hard disk drive, with 120 GB of memory and is available for CableCARD™, Ant 1, Ant 2, IEEE 1394 or tuning devices (cable boxes or satellite receivers) connected to inputs 1, 2, 3 when a PIP or POP is not displayed.

The TV can convert digital channels and IEEE 1394 device signals to analog signals that can be recorded on NetCommand compatible analog VHS and S-VHS VCRs.

You can schedule the recording to take place at a later time and program the recording duration for a minimum of 30 minutes and a maximum of 6 hours (in 30 minute increments). The default is 1 hour. During the recording, the TV can be powered Off. If the TV is powered On, it will be tuned to the source that is being recorded. The TV should remain on this source to ensure the recording continue without interruption.



Figure 13. Record to screen

## Recording Now

Can be used when viewing Antenna 1 or 2, an IEEE 1394 device including TV Disc, or a non-recording traditional device.

To initiate recording now:

1. Press REC (record) on the TV remote.
2. Press DEVICE on the remote control to move to the Source Device section.
3. Press ADJUST ▲, ▼, ◀ or ▶ to select the source device you will record from. If a source is not displayed, it is not available as a recording source.
4. Press ENTER to confirm selection and return to the “Record to” section.
5. In the “Record to” section, review the destination device and duration. Use ADJUST ▲ or ▼ to change, if necessary.
6. Press a second time and the recording will start.

## Time-Delayed Recording

1. Press REC (record) on the TV remote.
2. Press DEVICE on the remote control to move to the Source Device section.
3. Press ADJUST ▲, ▼, ◀ or ▶ to select the source device you will record from.
4. Press ENTER to confirm your source device selection and move to the Record to section.
5. Press ADJUST ◀ or ▶ to select the Record to device, duration time, start time (press ENTER after selecting hour, minutes and AM or PM to set the time) and day, using ADJUST ▲ or ▼ to change. For devices that can select channels, select the channel.
6. Select Add and press ENTER to add the recording to the record list. If your selection is successful, a confirmation message will be displayed. If you pick overlapping times, day(s), or destination devices, you will see a message stating there is a conflict.
7. To exit, press HOME on the TV remote after all recordings have been added.



# Record List, Peer-to-Peer Connections

## Record List

Figure 14

Press GUIDE while viewing the Record To screen to see a list of all currently programmed recordings. A maximum of 32 recordings can be scheduled.

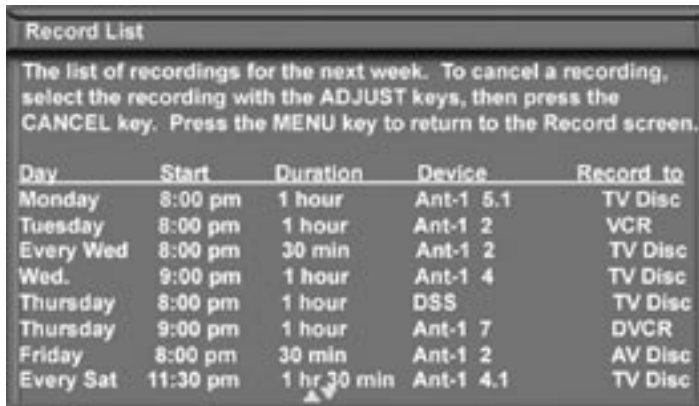

The list of recordings for the next week. To cancel a recording, select the recording with the ADJUST keys, then press the CANCEL key. Press the MENU key to return to the Record screen.

Day	Start	Duration	Device	Record to
Monday	8:00 pm	1 hour	Ant-1 5.1	TV Disc
Tuesday	8:00 pm	1 hour	Ant-1 2	VCR
Every Wed	8:00 pm	30 min	Ant-1 2	TV Disc
Wed.	9:00 pm	1 hour	Ant-1 4	TV Disc
Thursday	8:00 pm	1 hour	DSS	TV Disc
Thursday	9:00 pm	1 hour	Ant-1 7	DVCR
Friday	8:00 pm	30 min	Ant-1 2	AV Disc
Every Sat	11:30 pm	1 hr 30 min	Ant-1 4.1	TV Disc

Figure 14. Record List screen

## Cancel Current Recordings

To cancel a recording in progress, press DEVICE to display the Device Selection menu and highlight the source of the recording. Confirm that the icon for VCR (or recording device) is in the Connection Section next to the TV icon. Press the CANCEL button. The icon for the VCR (or recording device) will disappear from the Connection Section to confirm the cancellation.

To cancel a recording on the Record List, press ADJUST ▲ or ▼ to select the recording, then press CANCEL. To page through the list, press CH ▲ or ▼.

## Peer-to-Peer Connections

A peer-to-peer connection allows the IEEE 1394 devices in your TV network to talk to each other without the further need of TV intervention once the peer-to-peer connection is established. For example, the TV can setup a connection for an A/V Disc or DVCR that sends a recorded program to an IEEE 1394 monitor in another room. NetCommand will establish the connection between the two devices. Once the connection has been established, the TV can be turned off or used to watch another device. Recording from digital channels to a DVCR is also a peer-to-peer connection. In this case, the TV is one of the devices in the peer-to-peer connection.

**NOTE:** Multiple peer-to-peer connections can occur simultaneously, sometimes with the same source device.

## Setting up a Peer-to-Peer Connection

To establish a peer-to-peer connection:

1. Press CONNECT on the TV remote.
2. Press DEVICE on the remote control to move to the Source Device section.
3. Press ADJUST ◀ or ▶ to select the source device you will record from.
4. Press ENTER to confirm selection and return to the “Record to” section.
5. In the “Record to” section, review the destination device (example: DVCR) and duration. Change if necessary.
6. Press CONNECT a second time to start recording.

## Canceling a Peer-to-Peer Connection

After a peer-to-peer connection has been established, you can cancel it by highlighting the source device in the Device Selection menu. Confirm that the on-screen icon for the peer-to-peer connection is in the Connection Section next to the TV icon, then press CANCEL. The connection will end and the destination icon will be removed. If there is more than one peer-to-peer connection for the same device, all of the connections will all be canceled.

# Using TV Disc & A/V Discs

## TV Disc & A/V Disc Track List Screen

Figure 15

When viewing the TV Disc or an A/V Disc, press GUIDE to display its Track List. The Channel, Station, Date, Time, Program name and whether it has been Watched (Y=yes, N=no) will be displayed. Tracks will be listed in date and time order and will vary in size.

Press ADJUST ▲ or ▼ to navigate through the Track List. Press INFO to see the recording's length and the amount of memory it will use. Free disc space is displayed in the title line. If the broadcaster has sent detailed information regarding the program, it will also display when you press INFO. To play a track, select it on the list, then press ENTER. To change pages, press CH ▲ or ▼. To delete a track, select it on the list and press CANCEL. Press CANCEL again to confirm.



Figure 15. Track List screen for TV Disc

## TV Disc or A/V Disc Search

NetCommand is able to search to a specific time in a recording on the TV Disc or an IEEE 1394 A/V Disc.

1. Start the desired track's playback on the A/V disc.
2. Use the number buttons to enter the time code position of hours followed by minutes. For example, to enter one hour and twenty-two minutes (1:22) into the track, enter 1, 2, 2.
3. Press ENTER to skip to the time code position.
4. To cancel the request or to start over, press CANCEL instead of ENTER.

## Archiving TV Disc Digital Recordings

To permanently store a COPY FREE digital recording from the TV Disc on D-VHS or other IEEE 1394 device:

1. Press DEVICE on the remote control and select TV Disc by pressing ADJUST ◀, ▶, ▲ or ▼ and then ENTER.

2. Press ADJUST ▲ or ▼ to select a track. Then press ENTER to start playing.
3. Press PAUSE to pause the playback.
4. Press REC (record) on the TV remote. The Record To screen will display.
5. In the "Record to" section, review the destination device (DVCR, VCR). Change if necessary.
6. Press REC a second time to initiate recording.
7. The TV Disc and destination device cannot be viewed or used while recording. To view a different device, press DEVICE and select.

### IMPORTANT

Analog programs cannot be transferred from the TV Disc and the TV Disc is not intended to act as permanent storage of digital recordings. Mitsubishi recommends you transfer important digital recordings to an external device such as a D-VHS VCR. Recordings stored on TV Disc are lost and cannot be recovered if the TV Disc requires replacement or repair. Mitsubishi is not liable for lost recordings.

## Using the Remote Control with TV Disc or A/V Disc after selecting from the Device Selection menu:

GUIDE:	displays the Track List of recorded programs.
PLAY:	resumes playback of paused program.
PAUSE:	pauses or resumes playback of program.
FF/FWD:	forward picture search, multiple presses increase the speed.
REW/REV:	reverse picture search, multiple presses increase the speed.
ADJUST ◀:	skip backward 12 seconds per press.
ADJUST ▶:	skip forward 30 seconds per press.
ADJUST ▲:	skip to the end of the track.
ADJUST ▼:	skip to the beginning of the track.
REC:	Display the Record Menu to schedule recordings

If the TV Disc is the default digital record device (Setup menu), you can also schedule recordings from ChannelView.

# Direct VCR Recording from an Antenna or Cable Source, Copy-Protected Material and Restrictions for Traditional VCRs

## Direct VCR Recording from an Antenna or Cable Source:

Pressing REC (record) on the TV's remote control will function the same way as pressing the record button on the VCR's remote control or front panel.

To record directly from antenna or cable:

1. Press DEVICE on the TV's remote to display the Device Selection menu. Highlight the traditional VCR and press POWER to turn on the VCR. If necessary, press GUIDE to select the input the VCR is on, such as Antenna input (or line input).
2. Press ENTER to switch the TV to the VCR.
3. Select the correct channel for recording on the VCR and then press REC to start recording. You will need to manually stop the recording at the end of the program.

OR...

4. Press the DEVICE MENU button to display the VCR's menu to schedule a delayed recording directly from antenna or cable.

To record from Ant-1, Ant-2 or other devices, see NetCommand Controlled Recordings.

## Copy-Protected Material

When attempting to record copy-protected material, the Record functions of the NetCommand and IEEE 1394 systems may be prevented or stopped. If you have a recording that is tagged "Record Once", NetCommand will change the tag to "Record No More".

## Restrictions for Traditional VCRs

If turned On, the TV must be tuned to the source device.

- Your VCR should be connected directly to Audio Video 1.
- The VCR must be set manually to "Line Input". Display the Device Selection menu, highlight the VCR and press GUIDE to change VCR inputs.
- The TV can select channels on compatible cable boxes for recordings. Leave the cable box turned on.
- If the source device or recording device does not have separate power On and Off features, then leave that device powered On.

# PC Viewing

## PC Input

Figure 16

To display your PC screen on the TV, first, connect it to the TV's back panel (see Chapter 2). You will then be able to select it through the Device Selection Menu. For the correct screen resolution (pixels), use the PC's Control Panel settings.

Your Mitsubishi TV can display resolutions from standard VGA (640 x 480) through PC 720p (1280 x 720), 60Hz refresh rates only. See Appendix B, in this book for more screen resolutions. The instructions below are for most PC's.

1. In the PC's "Start" menu, select "Settings".
2. Select "Control Panel".
3. Select "Display".
4. Choose the "Settings" tab.
5. Depending on your PC, either:

Use the Screen area slider or use the Screen Resolution slider to adjust the resolution.

You may need to restart the PC for this change to take effect.

**Hint:** You may want to set the computer's screen saver to a pattern, to display after several minutes, as a reminder that the TV is still powered on and time is being added to the lamp's elapsed hours. Even if the screen appears dark, if the TV's power is on, the lamp is in use.

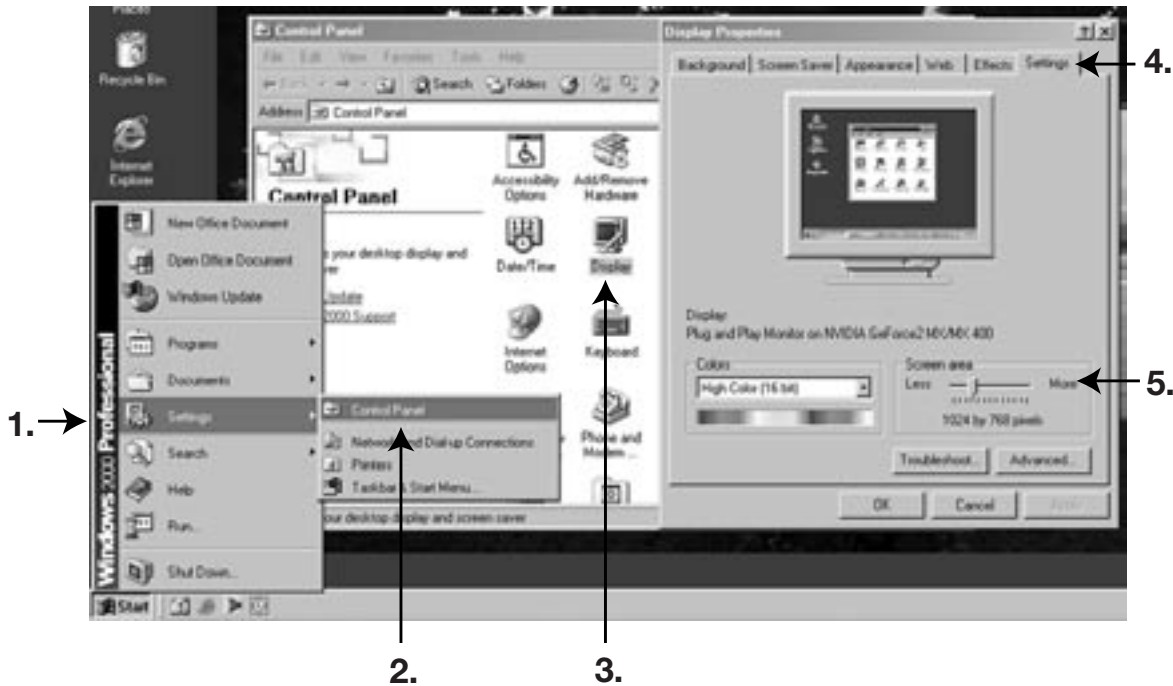

Figure 16. PC resolution XGA selection

# MediaCommand™ and Media Card Playback

**Warning:** Some media cards available on the market are not properly certified to follow the card type specifications noted below and cannot be used by the Card Reader. If you experience problems with the reading of your file, please transfer your files to a properly certified card.

## Media Card Slots

### Inserting a media card

1. Insert a card into a matching card slot on the front of the TV. Be sure to use the correct card slot. Card 1 will accept MultiMediaCard™ and SD Media Card. Card 2 will accept SmartMedia™. Card 3 will accept CompactFlash®. Card 4 will accept MEMORY STICK™. Cards up to 128mb, with a file format of FAT 16 (block size = 1024 or 2048) are supported.

Normally the label side should be up, but if the card does not fit, try turning the card over and insert again. When properly inserted, the light next to the slot will light up.

2. Press DEVICE on the remote control to display the Device Selection Menu and then select the correct card slot from the list, using ADJUST ◀, ▶, ▲ or ▼.
3. The Media Dialog box (figure 17) will automatically display. Use the AUDIO button to switch from JPEG Picture Slideshow setup to MP3 or WMA7 Audio Playlist setup or use the VIDEO button on the remote to switch from the MP3 or WMA Audio Playlist setup to JPEG Picture Slideshow setup.

**Don't pull the media card out while it is playing.**

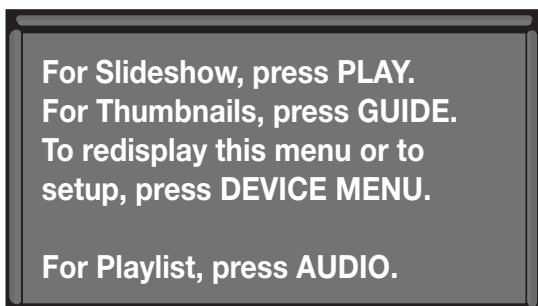

Figure 17. Media Dialog Box

4. On the remote control, press:

**PLAY:** to start the slideshow or play audio.

**GUIDE:** to display the JPEG Thumbnail menu (Figure 18) or Audio track playlist (Figure 19)

**DEVICE**

**MENU:** to display the Media Setup menu (Figure 20).

## Remote Control Buttons for Controlling the Playback

### For JPEG Pictures Slideshow:

- PLAY:** begins or resumes slideshow playback  
**PAUSE:** pauses or resumes playback while in the automatic advance mode.  
**FF:** skips to the next slide.  
**REW:** returns to the previous slide.  
**FORMAT:** single press rotates the slide 90°. Multiple press continues to rotate the slide.  
**STOP:** Stop slideshow, return to media card screen.

### For MP3 or WMA Audio Playback

- PLAY:** begins or resumes playlist playback.  
**PAUSE:** pauses or resumes playback.  
**FF:** skips to the next track/song.  
**REW:** skips to the previous track/song.  
**STOP:** Stop playback and returns to media card screen.

## Using the Picture Thumbnail Menu or Audio Playlist Menu

### For JPEG Picture Thumbnail Menu:

Figure 18

1. Press GUIDE on the remote to display the JPEG picture Thumbnail menu.
2. Press ADJUST ◀, ▶, ▲ or ▼ to move the highlight to different images (CH up/down will change pages of the Thumbnail menu). Use REW to go to the first slide and FF to go to the last slide on the page.
3. Press FORMAT to rotate the selected image 90° (pressing FORMAT four times will rotate the image completely around to the original position).
4. Press PLAY to begin playback of the Slideshow from the selected image. The Thumbnail menu will be taken down.



Figure 18. JPEG Thumbnails

# Media Command™ and Media Card Playback, continued

## For MP3 or WMA7 Playlist Menu:

Figure 19

1. Press GUIDE to display the Playlist menu.
2. Using ADJUST ▲ or ▼ to move the highlight to different tracks (CH up/down will change pages of the Playlist).
3. Press PLAY to begin playback. The Playlist menu will be taken down. An asterisk (\*) will be next to the song currently playing.



Figure 19. Audio Playlist

## COMPATIBLE PICTURE OR AUDIO FILES: For JPEG Pictures up to 128MB:

1. Still images recorded on digital cameras using the Exchangable Image File Format, version 2.1 (EXIF 2.1) standard for digital still cameras and Design Rules for Camera File Systems version 1.0 (DCF 1.0).

Some images opened and resaved on a computer may not playback or may not be able to display a picture in the thumbnail list because the computer program that opened and resaved the images changed the file to an incompatible format.

2. Standard digital images with a maximum size of 5-megapixels for each image, or 2560 x 1920 pixels. Pictures will be scaled to the TV display. Some pictures may be cropped to fit.
3. Full path file names can be no longer than 50 characters and must end in a .jpg extension. Not all 50 characters will display.

## For MP3 or WMA7 Audio files:

1. Files recorded with sampling rates of 32 kHz, 44.1 kHz or 48 kHz.
2. Files recorded with fixed bit rates
3. File names with .mp3 or .wma extensions

**NOTE:** During MP3 or WMA7 audio playback, audio from the cards will be sent to the A/V receiver as analog audio. Digital out is not available.

## Media Setup Menu

Figure 20

Press DEVICE MENU at any time to display the Media Setup screen, where you can adjust the Slideshow Display, Frequency, Interval or Playlist Frequency.

## For JPEG Picture Slideshow Setup

- For JPEG picture Slideshow playback, select Automatic or Manual advance. For manual operation, press PLAY or ENTER on the remote control to advance each slide.
- For automatic advance, select the frequency or number of times to show the complete slide show, Once, Twice or Continuously.
- For automatic advance, select the interval time each slide is shown, for example, 5 seconds, or 30 seconds.

## For MP3 or WMA7 Audio Playlist Setup

- Select the frequency or number of times to play the complete playlist. Once, Twice or Continuously.

To exit, press DEVICE MENU on the remote control to redisplay the media card screen or press HOME to return to TV viewing.

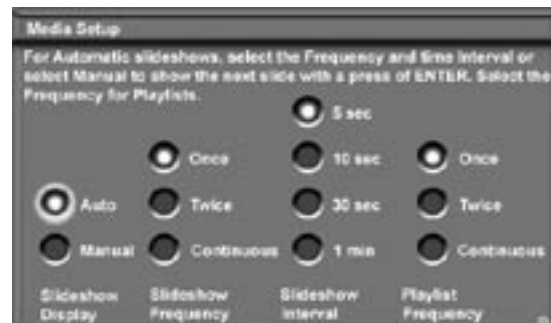

Figure 20. Media Setup Menu

### **IMPORTANT**

**JPEG images cannot be edited through the TV. Only name changes should be made on your PC to avoid file incompatibility problems.**

**MP3's must have at least 32 kHz sampling rate.**

# Chapter . . .

# 5

## TV Menu Screen Operations

Main Menu Choices .....	64
Setup Menu .....	65
NetCommand® Menu.....	67
Antenna Menu .....	68
Time Menu .....	70
Captions Menu .....	71
V-Chip Lock Menu .....	73
AudioVideo Menu .....	76
A/V Settings Descriptions.....	77
Operation of PIP and POP.....	79

# Main Menu Choices

## Setup Menu

Figure 1

Use the Setup menu to select English or Spanish as the language for the menus and on-screen displays.

Adjust Color Balance Automatically or manually (PerfectColor™). Color Balance uses six colors, Magenta, Red, Yellow, Green, Cyan and Blue to obtain color balance. Reset the Color Balance to the factory default settings.

Select the default setting for the TV Pause feature. View the TV's software version on this screen.



Figure 1. Main menu, Setup selected

## NetCommand® Menu

Figure 2

Add, change, review or delete NetCommand® settings and devices. If you have more than one digital recording device connected, use this menu to change the default digital Record To device. Turn the transport menu off and change the order of the icons in the Device Selection menu. Select analog quality for programs recorded on the TV Disc.



Figure 2. Main menu, NetCommand selected

## Antenna Menu

Figure 3

Memorize available analog and digital channels for Ant-1 and Ant-2. After memorization, if a channel displays as digital and analog, you can choose to see the channel digitally every time it is selected. Manually add or delete channels from memory, name channels or add your favorite channels to a SQV (SuperQuickView™) list.



Figure 3. Main menu, Antenna selected

## Time Menu

Figure 4

Manually set the time for the TV, or select Auto and the TV will automatically set the time based upon Extended Data Service (XDS) time data. This time data is usually broadcast by your local PBS station. This menu is also used to set the TV timer.



Figure 4. Main menu, Time selected

## Captions Menu

Figure 5

Display Closed Captions if sent by the broadcaster, select settings for analog or digital captions.



Figure 5. Main menu, Captions selected

## V-Chip Lock Menu

Figure 6

Block or allow programing based upon rating signals sent by the broadcast station, lock by time, or lock the front panel buttons.



Figure 6. Main menu, V-Chip Lock selected

## AudioVideo Menu

Figure 7

Reset the A/V Memory to return to the original factory A/V settings for a selected device. Customize the individual audio and video settings. Display a blue screen when viewing a device with no signal, enhance the darker parts of bright pictures or turn the TV speakers On or Off.



Figure 7. Main menu, Audio/Video selected



# Setup Menu

## Setup Menu

Figure 8



Figure 8. Setup Menu, NetCommand Option

## Language

Display the on-screen menus in either English or Spanish (Español). The first time you powered On your TV, you were requested to select an on-screen menu language. If you choose to change the selection, all menu text will immediately switch to the language of your choice.

Program titles and other information sent by a broadcaster will be shown in the original language.

## Color Balance

Your Mitsubishi TV uses six colors (Magenta, Red, Yellow, Green, Cyan and Blue) to create color balance. You may adjust the intensity of the colors automatically or manually (PerfectColor™) or reset them to the default settings. Each TV input or device has a memory for PerfectColor.

### Auto (Color Balance)

If the Auto box is checked, your TV will optimize color automatically and continuously. Both PerfectColor and Reset options for Color Balance are grayed out and unavailable.

### PerfectColor™ (Manual Color Balance)

Figure 9

The PerfectColor (manual) option is only available when Auto (Color Balance) is not checked. Select PerfectColor and press ENTER to display the menu. Individual sliders for Magenta, Red, Yellow, Green, Cyan and Blue will be displayed. The sliders have a numeric value, where 63 is the maximum. The default setting for each color is 31 (center). Highlighted text will show which slider you are adjusting. Each active input can be individually adjusted.

Press ADJUST ▲ or ▼ to navigate between colors and ADJUST ◀ or ▶ to change the color slider settings.

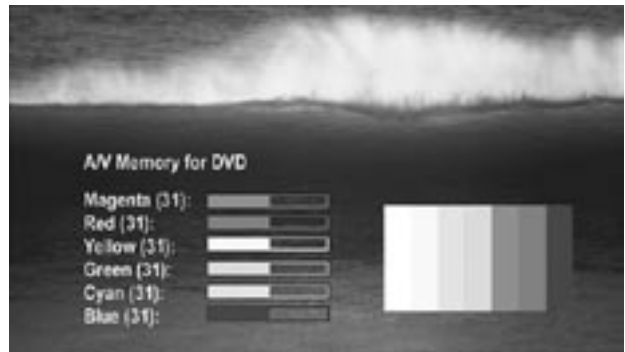

Figure 9. PerfectColor Menu, Manual Color Correction

## Reset

Select to reset the Color Balance settings. Each active input can be individually reset, if Auto is not checked.

## TV Pause

TV Pause is a special feature of the internal TV Disc personal video recorder (PVR). TV Pause is available for CableCARD™, Ant-1, Ant-2, IEEE 1394 input and tuning devices (cable boxes or satellite receivers connected to Inputs 1,2 or 3).

This feature allows you to press PAUSE to “pause” live TV. You can then search backwards or forwards through the current TV program. When you pause the TV program, an on-screen slider will show approximately how far and in which direction(s) you can search.

TV Pause has three settings:

- **On Request:** TV Pause is in the standby mode until you press PAUSE for the first time after turning on the TV, or after a channel or device change. There will be a few seconds delay before a paused picture appears. During this pause, you will not be able to scan or skip backwards in the TV Program. Later uses of TV Pause while in the same program, will allow reverse scan or skip of the available TV program as shown on the slider. The TV Pause will return to the standby mode automatically when you change the channel or device. The PIP/POP features are available only when TV Pause is in the standby mode and not enabled.

# Setup Menu, continued

- **Always:** Press PAUSE, REW, FF or any ADJUST button to pause the program and scan or skip within the program. You can skip or scan backwards through the available programming as indicated on the slider. You can also scan or skip forward to catch up to the live broadcast. You cannot skip or scan backward to a point before the last channel or device change. In the Always setting, the PIP/POP features are not available. To use the PIP/POP features, select the Off or On Request setting for TV Pause.
- **Off:** This mode prevents the TV Pause function, however, full screen picture freeze is available. If you do not expect to use the TV Pause features, we recommend the Off or On Request mode. This mode allows PIP/POP features to be used.

- Press ADJUST ▼ to skip back to the earliest available part of the TV program as shown on the slider.

If you wish to save this program press REC to display the record menu and begin a formal recording. You can press GUIDE to display ChannelView and then record.

## Software Version

For some service related issues, it may be necessary to know which software version is in your TV. This information is displayed on the Setup menu screen.



Figure 10. TV Pause slider

### Controlling the TV Pause Features:

NOTE: You cannot reverse search further back than the beginning of the filled space as shown on the slider. You cannot forward search past the live broadcast point.

- Press PAUSE to pause the current TV program or resume play after pause.
- Press PLAY to resume watching the TV program from the pause point.
- Press FF to forward picture scan. Press up to 4 times to increase the scan speed. If pressed when TV is paused, then will move forward at half speed, not fast forward.
- Press REW to reverse picture scan. Press up to 4 times to increase the scan speed. Pressed when TV is paused, then will reverse at half speed.
- Press ADJUST ◀ to skip backwards 12 seconds (for each press).
- Press ADJUST ▶ to skip forward 30 seconds (for each press).
- Press ADJUST ▲ to skip all the way to live broadcast.

# NetCommand® Menu

## NetCommand Menu

Figure 11



Figure 11. NetCommand Menu

### Edit

Detailed information regarding setting up and editing the NetCommand menu is found in *Chapter 3*. The Edit NetCommand screens allow you to add new devices, change or edit traditional and IEEE 1394 devices, turn devices and unused inputs On or Off, delete a single device or delete the entire setup configuration. If you choose to delete the entire configuration, or if the NetCommand setup was cancelled, deleted or not completed, you can start at the Initial NetCommand screen. The Review screen shows all devices connected to the TV.

### Transport Menu

Figure 12



Figure 12. Transport Menu

Selecting On for the Transport menu allows NetCommand to use the Transport menu to control the TV Disc, VCRs, DVDs, IEEE 1394 AV Discs, digital VCRs, and similar devices. If you choose to turn off this menu when viewing the devices, the transport buttons (rewind, play forward, stop, pause and record) on the TV's remote control will continue to operate these devices. In the Device Selection menu selecting a VCR or DVD Player will automatically display the Transport menu. You can re-display this menu by pressing DEVICE MENU.

Select Transport menu functions by pressing ADJUST ◀ or ▶ and then ENTER. For example, to pause playback, press ADJUST ◀ or ▶ to move to PAUSE, then press ENTER. If a function is not possible, such as record for a DVD Player, the Transport menu button will be grayed out.

Note: Transport buttons (rewind, play forward, stop, pause and record) on the remote control are located in the bottom section of the remote control.

### Icon Order

Figure 13

The Icon Order screen allows you to arrange the device icon order on the Device Selection menu to a different sequence, for ease of selection and operation. To change the order, press ADJUST ▲, ▼, ◀, or ▶ to highlight the icon to be moved and then press ENTER. Press ADJUST ▲, ▼, ◀ or ▶ to move the icon to the desired position and then press ENTER to release the icon.



Figure 13 Icon Order Menu

### Analog Quality

For analog programs recorded on the TV Disc or an A/V Disc, you can select the recording quality. High has the best quality, but takes more disc space. The Low quality takes less disc space. The default is High.

### Default Digital Device

If multiple recording devices are available in NetCommand, this setting allows you to choose the device to use when recording digital programs. A digital recording can be made on either a digital or analog device although the quality will not be as good if recorded on an analog device. For best playback quality, record digital programs on a digital recording device.

If multiple devices were not connected and then added in the NetCommand setup, this setting will be unavailable (grayed out). Analog recordings can only be made on the one analog device connected to Monitor Out (usually a VCR) and are not affected by this setting. This feature is most useful when recording from ChannelView™ (page 55).

# Antenna Menu

## Antenna Menu

Figure 14



Figure 14. Antenna Menu

The Antenna Menu options are available for use with analog and digital channels on Antenna-1 and Antenna-2. You can memorize channels, add or delete channels, name channels and add channels to an SQV (Super Quick View™) bank.

## Memorize

### For Antenna 1 (Main) or Antenna 2 (Aux)

Select either Air (when used with an indoor/outdoor antenna) or Cable (when used with direct cable) then press ENTER to start the automatic channel memorization process. If a CableCARD™ is being used, memorized channels are provided by your cable provider through the CableCARD.

To stop the automatic channel memorization process, press CANCEL. Channels memorized before you pressed CANCEL are retained in memory.

After memorizing channels, the channels in the memory can be accessed in ascending or descending order by pressing CH ▲ or ▼.

The memorization will occur twice, as the TV memorizes analog and digital channels separately.

## Prefer Digital

When a memorized channel is available as both analog and digital, a check mark in the Prefer Digital box will allow digital channels to display and analog channels to be hidden (when using CH). Removing the checkmark will show both analog and digital choices.

## Channel

Channels can be changed in 3 ways:

1. By pressing ADJUST ▲ or ▼ to select the channel.
2. By pressing CH ▲ or ▼ for channels already in memory.
3. Directly entering the number. With so many current and potential channels, the number range is greatly expanded. Channels can be one part, analog or digital (up to the number 16383) or two part, for digital channels (these use a separator). For a two part digital channel, you may press SUB/CANCEL on the remote to enter a separator after the first, second or third number, depending on the broadcaster's channel information.

For digital channels, when the broadcaster has sent a virtual channel number, the virtual channel number is shown in the text box and as a reference, the original digital channel is shown below the text box.

## Memory

After the available channels have been memorized with Memorize, weaker channels can be added. Unwanted channels can also be deleted. Press CH ▲ or ▼ on the remote control to see the channels in memory. Press ADJUST ▲ or ▼ to select Added or Deleted for the channel shown in the Channel number box.

## Name

Analog channels shown on Antenna-1 or Antenna-2 can be named (up to four characters). After you enter a name, it will appear on the TV screen, next to the channel number.

1. Press ADJUST ▲ or ▼ to select each letter.
2. Press ENTER to set the letter and move to the next letter position.
3. Press CANCEL to move back one position.

Digital channels are automatically named if the broadcaster sends the information.

# Antenna Menu, continued: SuperQuickView™ (SQV)

## SQV (SuperQuickView™)

### Using The Menu Screen

Figure 15

SQV (SuperQuickView™) allows you to put together banks of your favorite channels from Antenna 1 and Antenna 2. You can store channels in any of the 9 different SQV memory banks. You can also store the same channel in multiple memory banks. Once you have added a channel to an SQV memory, “SQV” and the memory bank number will appear under the tuned channel number on the TV screen.

### Adding SQV Channels

1. Select the channel using the “Channel” option box or press CH ▲ or ▼.
2. Highlight the bank (SQV1-SQV9).
3. Press ENTER to check mark the selected SQV memory bank.
4. Repeat for additional channels or banks.

### Removing SQV Channels

1. Highlight the box for the SQV bank number.
2. Press ENTER to remove the check mark.



Figure 15. Antenna Menu, SQV (SuperQuickView)

## SQV (SuperQuickView™)

### Using The Remote Control

#### Viewing and changing SQV banks using the remote control:

1. Press the SQV button.
2. To change memory banks, press a number button within 5 seconds of pressing the SQV button.
3. Press the SQV button repeatedly to cycle through the channels available in that bank.

#### Adding SQV channels using the remote control:

1. Press CH ▲, ▼ or number buttons to select the channel you want to add to the current SQV memory bank.
2. Press and hold the SQV button for about 2 seconds. When “SQV” and the memory bank number appear under the channel number, the channel has successfully been added.

#### Removing SQV channels using the remote control:

1. Press the SQV button and then the memory bank number.
2. Press the SQV button repeatedly until you see the desired channel.
3. While the channel number and SQV indicator (with correct bank number) are still displayed on the screen, press the CANCEL button. If the CANCEL button is not pressed before the SQV indicator disappears automatically, the channel will not be removed.
4. When the SQV indicator disappears, the channel has successfully been removed only from that bank. “Other” banks remain unchanged.

# Time Menu

## Setting the Clock

You may choose to manually or automatically set the clock that your TV will use for recording or timer functions. You cannot schedule recordings if the clock is not properly set.

### Manual

Figure 16

To manually set the clock, you need to select the current time, including AM or PM, current date, time zone for your area and the Daylight Savings time setting.



Figure 16. Time Menu, Manual Clock Setting

### Set Time

Press ADJUST ▲ or ▼ repeatedly to slowly select the hour or press and hold to quickly select the hour. Press ENTER to move to the minutes options. Press ADJUST ▲ or ▼ to select minutes, then press ENTER to select AM or PM.

### Set Date

Press ADJUST ▲ or ▼ to select the correct date.

### Time Zone

Select your correct time zone. Press ADJUST ▲ or ▼ to select the time zone (Atlantic, Eastern, Central, Mountain, Pacific, Alaska or Hawaii) for your area. Then press ADJUST ► to move to the Daylight Savings time option.

### Daylight Savings Time

Select the Daylight Savings time (DST) option that your state uses. Press ADJUST ▲ or ▼ to select Applies if your state or area uses DST, or Ignore if DST does not apply.

### Auto

Select the Time Zone and Daylight Savings time setting, as noted above. You may then tune to a channel (on Ant-1 or Ant-2) that uses Extended Data Service (XDS) time data, typically a PBS channel. The Auto

selection will automatically retrieve the correct time and date information from this channel. Be aware that if a channel displays incorrect time information, it is because of information sent from the broadcaster and is not a defect of the TV.

## Timer On/Off

Figure 16

The timer can be turned to On or Off. When On, you need to select the time and day to turn the TV On and the device and channel to display. At your preselected time, the timer will turn the TV On, and this message will be displayed: "Press a button for the TV to stay on". Press any button on the remote control within 5 minutes or the TV will turn itself Off.

### Set Time

Press ADJUST ▲ or ▼ repeatedly to slowly select the hour or press and hold to quickly select the hour. Press ENTER to move to the minutes options. Press ADJUST ▲ or ▼ to select minutes, then press ENTER to select AM or PM.

### Set Day

Select the day or days that the TV will turn on automatically. Press ADJUST ▲ or ▼ to select Everyday, Mon-Fri (Monday through Friday), or the individual days of the week.



Figure 17. Timer Menu (Timer On/Off)

### Device

Press ADJUST ▲ or ▼ to select the device to use when the timer turns on the TV. If the TV is already on, the timer will turn the TV to this selected device.

### Channel

When an antenna is the selected device, you may select any memorized channel. Press ADJUST ▲ or ▼ to select the channel and the TV will tune to this channel in memory when the timer turns it on. This includes sub-channels for digital choices.

# Captions Menu: Analog and Digital Captions

## Captions Menu

Figure 18

For analog channels broadcasters can send either Standard or Text closed captioning. Standard Closed Captions follows the dialogue of the characters on-screen and displays in a small section of the screen. Text Closed Captions often contain information such as weather or news and covers a large portion of the screen. On digital channels, broadcasters can send up to 6 different captioning selections. Each TV station may broadcast only one or two types of captions or none at all. The TV cannot decode Closed Captions received on Component 1, 2 or Input-DTV.



Figure 18. Captions Menu

## Analog Captions

The TV can display one of the following captions for Analog sources:

- **CC1, CC2, CC3, or CC4.** (Standard closed captioning signals).
- **Text1, Text2, Text3, or Text4.** (Text closed captioning signals).
- **On if mute. Closed captions when mute.** When selected, the standard closed captioning signal (CC1) will turn on/off by pressing MUTE on the TV remote control.
- **Off.** No closed captions.

### IMPORTANT

When analog text closed captioning is selected, a large black or gray box appears on your TV screen if no text is being sent.

## Background

To make the analog closed captions easier to read, you can choose to display the background color as either black or gray behind the captions.

## Digital Captions

The TV can display one of the following Captions for Digital sources:

- **Captions 1-6.** Sent by broadcaster.
- **On if Mute.** Closed captions when mute. When selected, the captioning signal (Caption 1) will turn on/off by pressing MUTE on the TV remote control.
- **Off.** No closed captions.

**Note:** If the broadcaster is only sending analog captions converted to digital, then the analog captions settings apply.

## Appearance

The Default options shows what the closed caption provider intended to send. You may select the Custom option to override and customize Closed Captions appearance. These settings do not apply to analog Closed Captioning converted to digital.

## Digital Settings

Figures 18 and 19

Digital Settings are available only when Custom was selected from Appearance (Figure 17) and do not apply to analog closed captions converted to digital. Select Digital Settings by moving the ADJUST buttons and pressing ENTER. You can select Font, Size, Color, Background, Opacity (Font) and Background Opacity.



Figure 19. Closed Captions Menu Digital Settings

# Captions Menu, continued: Customizing Digital Settings

## Fonts

You can customize the text of digital captions by selecting the font of your choice. The available Font options are as follows:

- Default - Selected by the Closed Captions provider
- Font 1 - Monospaced font with Serifs
- Font 2 - Proportional spaced font with Serifs
- Font 3 - Monospaced font without Serifs
- Font 4 - Proportionally spaced without Serif
- Font 5 - Casual font
- Font 6 - Cursive font
- Font 7 - Small Capitals font

## Size

You can also customize the text of digital captions by selecting your desired size of font. Large is the recommended font size.

## Color

You can customize the text of digital captions by selecting the color of font. The available font colors are as follows:

- White
- Black
- Magenta
- Red
- Yellow
- Green
- Cyan
- Blue

## Background

To make the digital closed captions easier to read, you can choose the background color. The available background colors are as follows:

- White
- Black
- Magenta
- Red
- Yellow
- Green
- Cyan
- Blue

**NOTE:** If you choose the same color for the fonts and background, Closed Captions will not be visible.

## Opacity (Font)

You can customize the visibility of your fonts using the following categories:

- Transparent - See-through text to the TV program

- Translucent - TV program is visible behind the text
- Opaque - Solid color text; blocks the TV program
- Flashing - Text flashes in intervals

### ***IMPORTANT***

**We recommend you use contrasting colors between captions and background. In particular, Black background with translucent opacity and White font are ideal.**

**Care must be exercised when selecting customized colors. Your choice may change the legibility or readability of captions.**

## Background Opacity

You can customize the background for digital captions using the following categories:

- Transparent - See-through background to the TV program
- Translucent - TV program is visible behind the background
- Opaque - Solid background; blocks TV program
- Flashing - Background flashing in intervals

### ***IMPORTANT***

**The content of captions is determined by the broadcaster. If your captions show strange characters, misspellings or odd grammar, it is not a malfunction of the TV.**



# V-Chip Lock Menu

## V-Chip Lock Menu Overview

The V-Chip Lock menu allows you to block or allow programs based upon rating signals sent by the broadcaster, or block TV viewing during specific times. You can turn the V-Chip Lock On or Off using the V-Chip menu or the V-CHIP button on the remote control. The TV comes from the factory with the V-Chip Lock in the Off setting.

When On, the factory preset is TV-PG for TV ratings or PG for movie ratings, allowing only programs rated TV-PG/PG or lower. Use the V-Chip Menu to change the allowable rating levels. After changing channels or devices, there may be up to a 5 second delay before the V-Chip lock takes effect.

### IMPORTANT

If you forget your four-digit Passcode, see Appendix A.

## Selecting a Passcode from the V-Chip Lock Menu

Figure 20

The V-CHIP PARENT LOCK screen shown below displays when you select the V-Chip Lock menu from the Main menu. To access the V-Chip Lock menu, input a four-digit passcode with the number buttons on the remote control, then press ENTER. You can delete a number and move back one space by pressing CANCEL or you can exit without inputting a passcode by pressing MENU or HOME before pressing ENTER. The next time you select V-Chip Lock you will see "...enter **your** passcode" instead of "...enter a **new** passcode".

### V-CHIP PARENT LOCK

To go to the menu, enter a new passcode.

— — — —

Use the NUMBER buttons and press ENTER.

Figure 20. V-Chip Entry screen from Menu

## V-Chip Lock Menu

Figure 21

The V-Chip Lock menu can be used in several ways. If you want to lock the entire TV during specific hours, select Lock by Time from the V-Chip Lock menu. To set the lock, press ADJUST ▲ or ▼ to select On or Off for Lock by Time. If you select On, then press ADJUST ► to move to the Lock Time box. Press ADJUST ▲ or ▼ to select Lock Time.

Press ADJUST ▲ or ▼ repeatedly to slowly select the hour or press and hold to quickly select the hour. Press ENTER to move to the minutes options. Press ADJUST ▲ or ▼ to select minutes, then press ENTER to select AM or PM. Repeat these choices to select the Unlock Time.

Setting the Lock Time and Unlock Time to the same time will make the Lock by Time active 24 hours a day.

During the Lock Time, you must use your passcode to view the TV.



Figure 21. V-Chip Lock Menu

## Front Button Lock

Figure 21

Front Button Lock lets you disable controls on the front panel to prevent unwanted setting changes.

Select On to lock out the operations of the front panel buttons and select Off to restore the operations of the front panel buttons.

If the front panel buttons have been locked and you misplaced the remote control, you can restore the function of the front panel buttons by pressing and holding the MENU button on the front panel for more than 8 seconds. If the TV is on, a message will display to confirm the release of the Front Button Lock.

# V-Chip Lock Menu, continued

## Using V-Chip with Program Ratings

Figure 22

You can choose the program ratings that you want to allow during specific times of the day by using the ADJUST buttons to highlight V-Chip from the V-Chip Lock menu and press ENTER. When you select V-Chip the screen in Figure 22 will display.

Press ADJUST ▲ or ▼ to select On or Off. If you selected On then press ADJUST ► to move to the TV Rating box. Press ADJUST ▲ or ▼ to select the TV Rating level you want to allow. Press ADJUST ► to move to the TV Content Categories and press ADJUST ▲ or ▼ to select. Press ENTER to add a check mark to the TV Content Categories you want to block.

Press ADJUST ► to move to the Programs Not rated box and press ADJUST ▲ or ▼ to select a program. Press ENTER to add a check mark to programs that are not allowed.

NOTE: If you select to block programs that carry the V-Chip rating Programs Not rated, you may block News or Emergency Bulletins, when “None” or “NR” Not Rated V-Chip rating is included. Care should be used when blocking programming that is not rated.

Press ADJUST ► to move to the Movie Rating box. Press ADJUST ▲ or ▼ to select the Movie Rating level you want to allow. See the next page for detailed information on rating guidelines.

To set the times when these guidelines will be active, press ADJUST ▲ or ▼ to slowly select the time, starting with the hours. Press and hold ADJUST ▲ or ▼ to quickly select the hours, press ADJUST ► to select the minutes.

By setting the V-Chip Start Time and V-Chip Stop Time to the same time, the V-Chip will be active 24 hours a day.



Figure 22. V-Chip Menu

## Using the Passcode from the V-Chip Lock Menu

When a channel or the TV is locked, figure 23 will display. To view a V-Chip blocked program or to watch the program during a scheduled lock time, you must enter your 4-digit passcode or change to an unlocked channel or allowed program. Once you have entered the passcode, the V-Chip Lock or Lock by Time will remain released until the TV is powered Off and then On again.

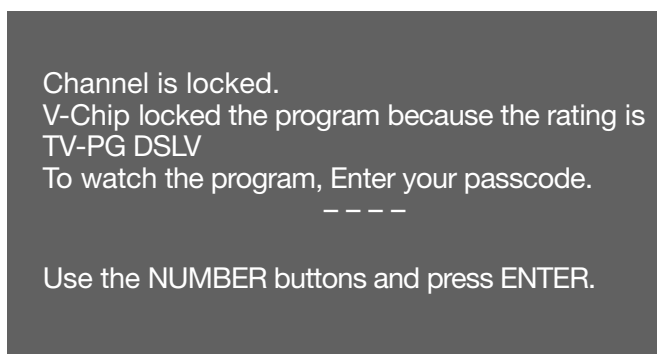

Figure 23. V-Chip Passcode screen

## Using the V-Chip from the Remote Control

Figure 24

You will see the screen shown below when you first press V-CHIP on the remote control. To quickly turn on or off the V-Chip Lock, input a four-digit passcode with the number buttons on the remote control, then press ENTER. To change any V-Chip settings, you must use the V-Chip Lock Menu.

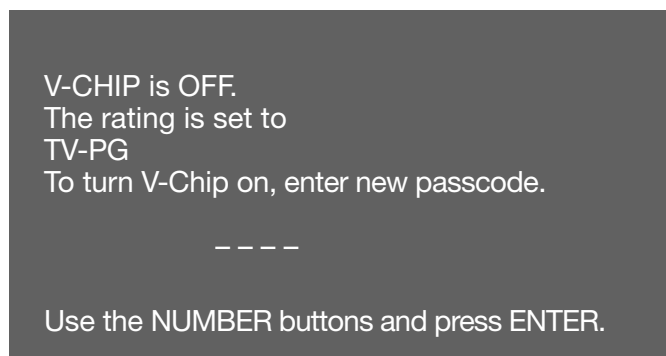

Figure 24. V-Chip Entry screen from Remote Control

# V-Chip Rating Guidelines

## V-Chip Signal Information

When provided by the broadcaster, V-Chip ratings can be used to control which programs can be viewed or will be blocked. When V-Chip ratings are sent, you will see the ratings when you change the channel or when you press the INFO button on the remote control. Both TV and Movie ratings will display. TV ratings apply to programs and movies developed for TV and may have supplemental blocking by content categories. Movie ratings use MPAA ratings for movies released in theaters.

### **V-CHIP EXCEPTIONS:**

- 1. V-Chip is not effective for programs viewed on devices connected to Component input or HDMI.**
- 2. Videotapes, laser discs and DVDs may not contain V-Chip rating signals. If they don't contain the V-Chip signal, V-Chip cannot block the program or movie.**
- 3. Broadcasters are not currently required to include V-Chip rating signals at this time. If the broadcaster does not include the V-Chip rating signal, V-Chip cannot block the program.**

### **TV Ratings:**

Used with TV programs and Made-for-TV movies.

- TV-Y** Youth, for children under the age of 7.
- TV-Y7** Youth, 7 years old and older. For children 7 years old and older.
- TV-G** General Audience. For the entire family to view.
- TV-PG** Parental Guidance. Parental Guidance is recommended, may not be suitable for some children.
- TV-14** Adolescent 14 years old and older. Not recommended for children under the age of 14.
- TV-MA** Mature Audience. For adults only.

TV Rating	FV	D	L	S	V
TV-Y					
TV-Y7	X				
TV-PG		X	X	X	X
TV-14		X	X	X	X
TV-MA			X	X	X

### **Content Categories:**

Used in association with the TV ratings above.

- FV** Fantasy Violence- applies to TV-Y7 only.
- D** Sexual Dialog- applies in different degrees to TV-PG and TV-14.
- L** Adult Language-applies in different degrees to TV-PG, TV-14, and TV-MA.
- S** Sexual Situations- applies in different degrees to TV-PG, TV-14, and TV-MA.
- V** Violence (graphic or realistic)- applies in different degrees to TV-PG, TV-14, and TV-MA.

**When you select a TV rating, you are selecting the least-restricted program level that can be viewed. As an example, if you select TV-PG, you are allowing programs rated TV-Y, TV-Y7, TV-G and TV-PG to be seen and blocking programs rated TV-14 and TV-MA. When you select a TV Content category, you will block all TV programs that have the same content category listing. As an example, if you select to block V (Violence) at the TV-14 level, you will also block any program that has the V category listing at the TV-PG rating level as well.**

### **Movie Ratings:**

Used with theater released movies and direct-to-video movies.

- G** General Audience- Designed for the entire family to view.
- PG** Parental Guidance- Parental Guidance is recommended, may not be suitable for some children.
- PG-13** Parental Guidance 13 years old and older- Not recommended for children under the age of 13.
- R** Restricted- Restricted in the theater to 17 years old and older unless accompanied by an adult.
- NC-17** No Children- Restricted in the theater to 18 years old and older.
- X** Adult- Designed for and restricted in the theater to adult audiences only.

**When you select a Movie rating, you are selecting the least restricted program level that can be viewed. As an example, if you select a movie rating of PG-13, you are allowing movies rated G, PG and PG-13 to be seen and blocking movies rated R, NC-17, and X.**

**Programs Not Rated:** Used for programs that are not rated like news, sports, weather, emergency bulletins, or movies such as those prior to or without MPAA Ratings. This does not include programs without V-Chip signals.

### **IMPORTANT**

If you select to block programs that carry the V-Chip rating "Programs Not Rated," you may block News or Emergency Bulletins, when "None" or "NR" Not Rated V-Chip rating is included. Care should be used when blocking programming that is not rated.

# AudioVideo Menu

## AudioVideo

Figure 25



Figure 25. Audio/Video Menu, Settings

## A/V Memory Reset

A/V Memory Reset allows you to select the device which will have the A/V Settings returned to the original factory settings. To return a device's memory to the original factory settings, select the device and then press ENTER.

## Settings

Each device has its own A/V memory. Select the device in A/V Memory Reset, then select Audio or Video to adjust the device's individual settings. Press ENTER, and the menu is removed and the individual settings are displayed.

Use ADJUST ▲ or ▼ to select the individual settings to be adjusted. Use ADJUST ◀ or ▶ to make the adjustment. For descriptions of the individual A/V settings see A/V Setting Descriptions, pages 77 and 78.

## Video Mute

Video Mute lets you display a blue background when no signal is being received on Inputs 1-3, MonLink, PC, Components 1-2 and Input DTV.

## Black Enhancement

Select On to enhance the contrast in bright scenes for better picture quality. Darker scenes will not be affected.

## TV Speakers

This selection will turn on or off the TV's internal speakers. You may select Off when sending the sound through a separate stereo system or surround sound A/V receiver. When NetCommand® is enabled, selecting the A/V receiver icon from the Device Selection menu automatically turns Off the TV speakers. See the NetCommand information for further instructions.

**Note:** To prevent damage from a sudden increase in volume, make sure the TV volume is set to low before setting speakers to ON.

## Using the AUDIO or VIDEO Button on the Remote Control

To adjust individual Audio or Video settings directly with the remote control:

1. Press AUDIO or VIDEO to cycle through the available settings.
2. Press ADJUST ◀ or ▶ to adjust the setting. After 5 seconds of inactivity, the setting display will disappear.

# A/V Setting Descriptions: Audio

**NOTE:** The effects of the Audio Settings of Bass, Treble, Balance and Surround affect the sound heard through the TV speakers only.

## Analog and Digital Audio Setting

A slider will display on-screen for most settings. When the slider is displayed it has a numeric value, where 63 is the maximum, 31 is the mid-point and 0 is the minimum.

### ◇ Bass

Enhances or reduces low-pitch sound.

### ◇ Treble

Enhances or reduces high-pitch sound.

### ◇ Balance

Adjusts the level of sound between the left and right speakers.

### ◇ Surround

Creates simulated stereo and surround effects through the TV speakers. Your choices are:

- Off: No surround effects.
- Surround Sound: Your TV will create a simulated surround effect when watching a stereo program.
- Simulated Stereo: Your TV will create a simulated stereo effect when watching a non-stereo program.

## Analog Only Audio Settings

### ◇ Listen to

Determines how your TV will receive a broadcast audio signal and play back the sound you hear.

Your choices are:

- Stereo: Default setting. The TV will play stereo broadcasts in stereo and mono broadcasts in mono. The word "Stereo" will be displayed when you tune to a channel broadcasting stereo.
- SAP (Second Audio Program): Additional monaural soundtrack that you cannot hear during normal TV viewing. The SAP signal might be related to the program you are watching, such as a soundtrack in a foreign language, or unrelated to the program you are watching, such as a weather report. If an SAP signal is broadcast, the letters "SAP" will be displayed when you tune to the channel.

- Mono: Reduces background noise and should be used when receiving a weak stereo audio signal. All audio will be played mono with this setting.

Listen to is not available for devices connected to the TV Inputs, Component inputs or 1394 devices.

### ◇ Level Sound

Turn On or Off to automatically equalize the volume level of programs containing significant level differences from one segment to another (for example, regular programming to commercials). To receive the best fidelity with music programs, you can turn this setting to Off.

## Digital Only Audio Settings

### ◇ Language

Determines what possible language you will hear. Your choices are:

- English
- French
- German
- Italian
- Portuguese
- Spanish
- "Other"

### ◇ Level Sound

Automatically reduces loud passages and boosts soft passages to a more uniform loudness. When connecting to an A/V receiver, set level sound to OFF and turn the TV speakers off to send full dynamics to the A/V receiver.

This feature only works with Dolby Digital sources. Other digital audio formats do not offer this dynamic range control. In these cases, no effect will be heard when changing the level sound setting.

# A/V Setting Descriptions: Video

## Video Settings

### ◇ Contrast

Provides a slider to adjust the white-to-black level. Low contrast shows a variety of shades in darker images, while high contrast shows darker images more uniformly black and makes colors appear more vibrant. In most home lighting situations, a medium contrast looks best. High contrast is good for brightly lit environments.

### ◇ Brightness

Provides a slider to adjust the overall brightness of the picture.

### ◇ Sharpness

Provides a slider to adjust the detail and clarity.

### ◇ Color

Provides a slider to adjust the color intensity.

### ◇ Tint

Provides a slider to adjust the proportion of red to green.

### ◇ Color Temp (Color Temperature)

Allows you to adjust how images are displayed. Your choices are:

- Low 6500K or Low (for DTV): White images will have a warm cast to them. This adjustment is an average and can vary due to ambient room lighting, video scene brightness and the TV's age. The Low 6500K represents the 6500K industry standard for NTSC (non-DTV) pictures.
- Medium: White images will be balanced between the Low (warm) and High (cool) settings.
- High: White images will have a cool cast to them. This setting may provide the most realistic picture under bright lighting.

### ◇ Video Noise

Use to reduce minor noise (graininess) in the broadcast received on Ant-1 and Ant-2 or Inputs 1-3, Component 1 and 2 and Input-DTV. Use standard with good quality signals.

### ◇ Film Mode (Auto) - On or Off

On is the automatic setting and will automatically

detect and apply film decoding correction for signals that originated on 24 frames per second film cameras and then were converted for broadcast to 30 frames per second video.

When the original signals originated on 30 frames per second video cameras, the On setting will automatically apply video decoding, the same as used with the Off setting. Try the Off setting when the TV seems to have difficulties and adds too many jagged edges to the images.

Film Mode is not effective for progressive scan (480p) devices, and high definition signals.

### ◇ DefinEdge

Selected image outlines are emphasized, resulting in sharper images, when On. When Off, the edge enhancer functions are prevented. The default is On.

**NOTE:** A slider will display on-screen for most settings. When the slider is displayed it has a numeric value, where 63 is the maximum, 31 is the mid-point and 0 is the minimum.

## For a Currently Viewed PC

### ◇ Auto Position

Press ENTER to automatically center the position of the PC video. This can be used whether the PC video is on the main or PIP/POP screen.

### ◇ HorizPosition (Horizontal Position)

Manually adjust the horizontal position of the PC, either on the main or PIP/POP screen. This selection will override the Auto Position selection.

### ◇ VertPosition (Vertical Position)

Manually adjust the vertical position of the PC, either on the main or PIP/POP screen. This selection will override the Auto Position selection.

### ◇ Fine Detail

Manually adjust the picture quality of the PC, either on the main or PIP/POP screen. This selection will override the Auto Position selection.

### ◇ PC Contrast

Manually adjust the picture contrast of the PC when it is the PIP or POP.

# Operation of PIP and POP

You can display programs from analog channels, analog inputs or devices as Picture-In-Picture (PIP) and Picture-Outside-Picture (POP). The TV has a second analog tuner for non-scrambled analog channels received on Ant-1 and will display them as the PIP/POP sub-pictures. Digital channels and devices can be shown as the main picture but cannot be the sub-picture. PC screens can be viewed in the side-by-side mode.

Press PIP/POP to activate the PIP/POP option. With each press of the PIP/POP button on the TV remote control (within seconds of each other), the PIP/POP will cycle through the following display options:

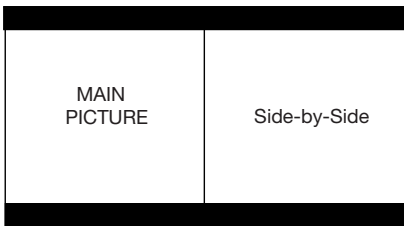

- **POP**  
side-by-side pictures

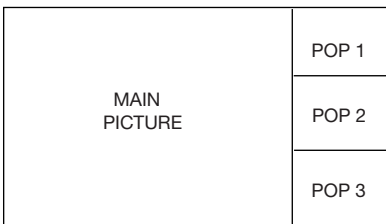

- **3 POP**

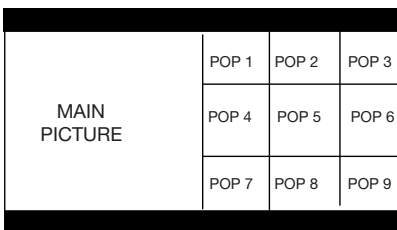

- **9 POP**

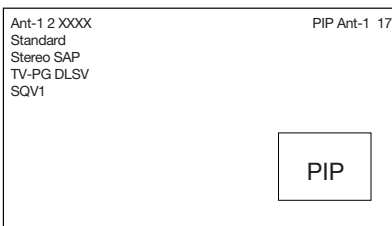

- **PIP large**

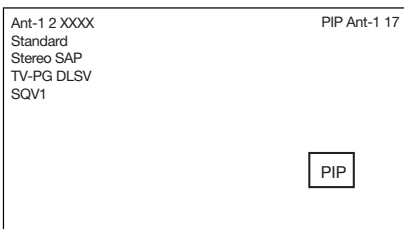

- **PIP small**

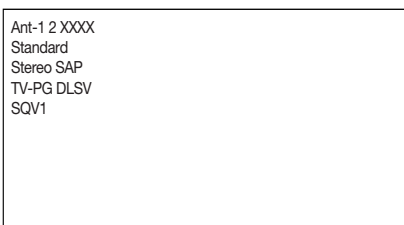

- **PIP/POP: off**

To turn PIP/POP off, wait at least 10 seconds, and press PIP/POP. The next time you activate PIP/POP, the last used PIP/POP option will be displayed

## Changing PIP/POP Device

Press PIP DEVICE to change the PIP or POP picture source device. A menu similar to the Device Selection menu will be displayed.

## Changing PIP/Side-by-Side Channels

Press PIP CH to scroll up and down through memorized channels on Ant-1 and Ant-2.

## Exchanging Program Images

Press EXCH to exchange the main picture and the PIP/POP picture. Pictures from digital channels can only be shown as the main picture.

## Moving PIP Image

If no menus are onscreen, press ADJUST ▲, ▼, ◀ or ▶ to move the PIP display anywhere on the main screen.

## Automatic POP Switching

When automatic POP switching is active, the TV will cycle through memorized analog channels on Ant-1 or Ant-2 or strobe pictures from other A/V components in the POP display. Press PAUSE to pause or restart automatic POP switching.

## Selecting POP “Live” Image

Press ADJUST ▲, ▼, ◀ or ▶ to select a different POP “live” image (automatic POP switching must be paused.)

## Freezing the PIP and Side-By-Side Picture

Press PAUSE to freeze the PIP and side-by-side images. Press PAUSE again to return to a “live” image.

### **IMPORTANT**

**Side-by-Side cannot show the same channel or device on both sides.**

**If Ant-1 or Ant-2 is the main picture, Ant-2 is not available as a PIP, POP or Side-by-Side.**

**PIP/POP is not compatible with signals from media cards.**

**If TV Pause is set to “Always” PIP/POP and Side-by-Side are not available.**





# Chapter . . .

# 6

## Special Features

Display Formats .....	82
Device Control with NetCommand® .....	85
Appendix A: Bypassing the V-Chip Lock.....	87
Appendix B: Specifications.....	89
Appendix C: Remote Control Programming Codes .....	91
Appendix D: On-Screen Information Displays.....	94
Appendix E: NetCommand® Specialized Device Keys .....	95
Appendix F: Cleaning and Service .....	96
Appendix G: Diamond Shield™ Removal .....	97
Appendix H: Filter Cleaning .....	98
Lamp Replacement.....	99
Troubleshooting .....	101
Additional Information.....	106
Index.....	107
Warranty .....	109

# Display Formats

This is a widescreen TV (also known as a 16:9 TV). This shape reflects the new types of images available from HDTV and many DVDs. There are still many older style narrow screen images (called 4:3 aspect ratio) you will encounter. While there will never be a perfect solution for displaying a narrow image on a wide screen, Mitsubishi offers several display formats to choose from.

Press **FORMAT** on the TV remote control to cycle through the available display formats. The last used format for each device will be used when you return to that device.

**Note: Not all formats are available for PIP/POP. Side-by-Side, 3 POP and 9 POP are only available in Standard and Expand formats. PC formats vary depending on PC signal.**

## Signals and Formats Definitions:

**480i Signals:** Traditional analog interlaced signals from or through Ant-1 & 2, Inputs 1-3, Component 1 & 2, Input-DTV and HDMI.

**480p Signals:** Progressive scan analog DVD signals on Ant-1 & 2, Component-1 & 2, Input-DTV and HDMI.

**720p & 1080i Signals:** High definition analog signals received through Component-1 & 2, Input-DTV and HDMI. These signals are always 16:9 (widescreen).

**SD 4:3:** Standard definition narrow screen format signals from digital channels and IEEE 1394 devices.

**SD 16:9:** Standard definition wide screen format signals from digital channels and IEEE 1394 devices.

**HD:** High definition wide screen format signals from digital channels and IEEE-1394 devices. These signals are always 16:9 (widescreen).

**Standard:** This is the full screen format. HDTV signals use this format. This format is useful to display Anamorphic DVDs that have 1.78:1 or 1.85:1 aspect ratios. Anamorphic DVDs that have a 2.35:1 aspect ratio will still display black bars at the top and bottom, but will show the entire image correctly. Narrow (4:3) images will be stretched evenly from side to side. Available for all signals.

**Expand:** This will enlarge the picture to fill the screen, cropping off some of the image at the top and bottom. This is useful to reduce the letterbox top and bottom bars of non-anamorphic DVD. Available for analog 480i, 480p and digital SD 4:3 signals only.

**Zoom:** This will enlarge the picture, cropping off some of the image at each side and top and bottom. This is useful to remove or reduce the black top and bottom bars on anamorphic DVDs with a 2.35:1 aspect ratio. Available for analog 480i and 480p and SD 4:3 signals only.

**Stretch:** This format will stretch a narrow (4:3) image across the screen, however, there is less stretch in the center than the sides. This will allow the entire narrow image to be displayed across the screen with less distortion than seen in the Standard format. Available for analog 480i and 480p and SD 4:3 signals only.

**Stretch Plus:** Similar to stretch mode, however to minimize distortions on the side, the picture is expanded to crop off portions of the top and bottom. Useful when no important information is shown at the top and/or bottom of the screen. Available for analog 480i and 480p and SD 4:3 signals only.

**Narrow:** This format will display narrow (4:3) images in their original shape, and add stationary black side bars to fill the screen. Available for 480i, 480p and digital SD 4:3 signals only.

**Wide Expand:** Enlarges the picture, cropping some of the image on both sides. This Expand format is useful to remove or reduce black side bars added to narrow images that are converted to 16:9 signals for digital broadcast. Available for analog 1080i, 720p, digital SD 16:9 and digital HD signals.

## DVD Definitions:

**Anamorphic (or Enhanced for Widescreen TV's):** These DVDs are recorded in a special way to properly show widescreen images on 16:9 TV sets in the Standard format mode. This is the recommended choice.

**Non-Anamorphic (or 4:3, 1:33:1, Letterbox or Full Screen):** These DVDs are recorded for use with traditional shaped TVs. They may be full screen (4:3 or 1:33:1) which crops movies to fit the narrow TV, or Letterboxed which adds black top and bottom bars.

This information may or may not be listed on the DVD case. Some DVDs support both types of recordings.

# TV Display Formats

## ORIGINAL SIGNAL Non-anamorphic or SD 4:3

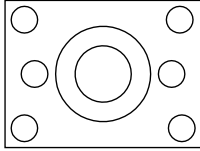

### TV Display

Standard

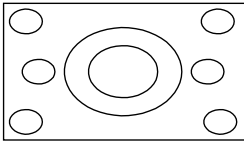

(not recommended, distorted)

Expand

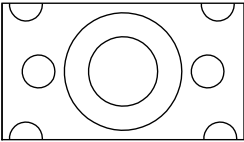

(recommended for letterboxed)

Zoom

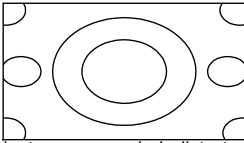

(not recommended, distorted)

Stretch

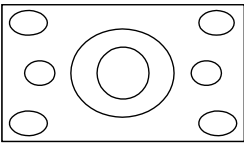

(recommended for standard broadcast)

Stretch Plus

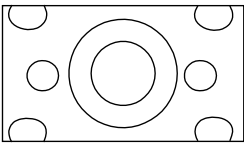

(recommended for standard broadcast)

Narrow

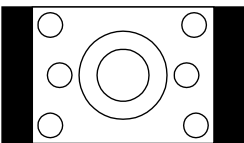

## ORIGINAL SIGNAL Anamorphic DVD

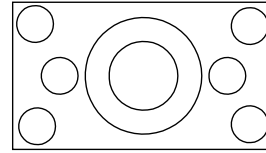

### TV Display

Standard

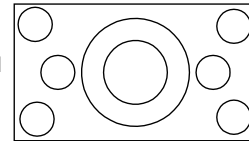

(recommended)

Expand

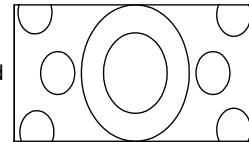

(not recommended, distorted)

Zoom

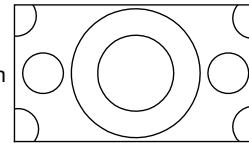

(recommended for anamorphic 2.35:1)

Stretch

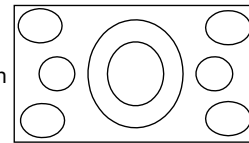

(not recommended, distorted)

Stretch Plus

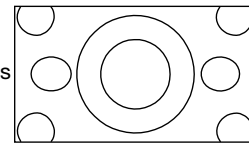

(not recommended, distorted)

Narrow

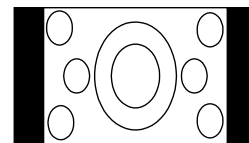

(not recommended, distorted)

not available for  
HD, SD 16:9 or  
analog 720p, 1080i

not available for  
HD, SD 16:9 or  
analog 720p, 1080i

not available for  
HD, SD 16:9 or  
analog 720p, 1080i

not available for  
HD, SD 16:9 or  
analog 720p, 1080i

not available for  
HD, SD 16:9 or  
analog 720p, 1080i

not available for  
HD, SD 16:9 or  
analog 720p, 1080i

not available for  
HD, SD 16:9 or  
analog 720p, 1080i

not available for  
HD, SD 16:9 or  
analog 720p, 1080i

not available for  
HD, SD 16:9 or  
analog 720p, 1080i

H  
D  
D  
I  
G  
I  
T  
A  
L

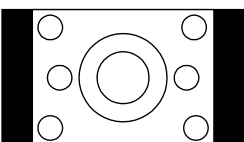

(with side bars in broadcast)

Original HD or SD  
16:9, 720p or 1080i



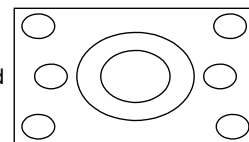







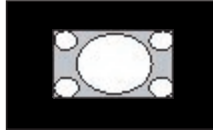

Wide Expand

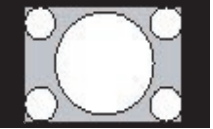

(recommended to remove side bars)

available only for  
digital SD 16:9, HD,  
analog 1080i or 720p

# PC Display Formats

Signal Format Original Pixel Count	Reduce 1	Reduce 2	Standard	Zoom
<b>VGA 4:3</b> 640 X 480  <b>WVGA 16:9</b> 848 X 480 <i>All 4 formats available for above inputs</i>			 640 x 480   848 X 480	 848 X 648   1149 X 648
<b>SVGA 4:3</b> 800 X 600  <b>WSVGA 16:9</b> 1084 X 600 <i>All 4 formats available for above inputs</i>			 800 x 600   1064 X 600	 864 x 648   1149 X 648
<b>XGA 4:3</b> 1024 X 768		 864 X 648	 1024 x 768	 1152 x 864
<b>PC 720p 16:9</b> 1280 X 720	 1088 x 612	 1152 x 648	 1280 x720	

# Device Control with Net Command®

<b>NetCommand Compatible Traditional Devices (Analog)</b>				
<b>When Device Selection Menu is Displayed and the Device is Highlighted (Yellow Outline)</b>				
<b>Device</b> <b>Remote Control Button</b>	<b>A/V RECEIVER</b>	<b>VCR</b>	<b>DVD</b>	<b>CABLE BOX/DBS</b>
<b>POWER</b>	Power On/Off (toggle)	Power On/Off (toggle)	Power On/Off (toggle)	Power On/Off (toggle)
<b>GUIDE</b>	Changes between digital and analog audio	Changes VCR inputs	n/a	Changes antenna inputs (RCA model DTC-100 only)
<b>FORMAT</b>	n/a	n/a	Changes output between interlaced and progressive	Changes output between HD and SD select models

<b>When Net Command® Compatible Traditional Device is Viewed or Played</b>				
<b>Device</b> <b>Remote Control Button</b>	<b>A/V RECEIVER</b>	<b>VCR</b>	<b>DVD</b>	<b>CABLE/DBS</b>
<b>CH up/down</b>		Channel up/down	Skip Forward/Backwards Chapter or Track	Channel up/down Page up/down when guide showing
<b>VOL up/down</b>	Volume Up/Down			
<b>MUTE</b>	Mute On/Off			
<b>0-9 (digits)</b>		number functions	number functions	number functions
<b>QV</b>				Last Channel Recall
<b>DEVICE Menu</b>		1st press Transport Menu, 2nd press Setup Menu display	1st press Transport Menu, 2nd press Setup Menu display	Setup menu display or Action function
<b>HOME</b>				
<b>ENTER</b>			Enter or select	Enter or select
<b>CANCEL</b>		Counter Reset	Exit or return	Exit or return
<b>GUIDE</b>			Disc menu display	Channel Guide
<b>ADJUST</b>			up/down left/right	up/down left/right
<b>PLAY</b>		Play	Play	
<b>STOP</b>		Stop	Stop	
<b>RECORD</b>		Record		
<b>REW/REV</b>		Rewind/Reverse	Reverse	
<b>FF/FWD</b>		Fast Forward or Fast Play	Fast Play	

# Device Control with Net Command<sup>®</sup>, continued

IEEE 1394 Devices				
When Device Selection Menu is Displayed and the Device is Highlighted (Yellow Outline)				
Device Remote Control Button	TUNER/ CABLE BOX/ DBS	A/V DISC	DVCR	AMPLIFIER
<b>POWER</b>	Power On/Off (toggle)	Power On/Off (toggle)	Power On/Off (toggle)	Power On/Off (toggle)
<b>GUIDE</b>	n/a	n/a	n/a	n/a
<b>FORMAT</b>	n/a	n/a	n/a	n/a

When an IEEE 1394 Device is Viewed or Played				
Device Remote Control Button	CABLE/DBS	TV Disc or A/V DISC	DVCR	AMPLIFIER
<b>CH up/down</b>	Channel up/down	Page up/down (when track list is displayed)	Index search forward/reverse (if supported by DVCR)	
<b>VOL up/down</b>				Volume Up/Down
<b>MUTE</b>				Mute On/Off
<b>0-9 (digits)</b>	number functions	Search by time (when followed by ENTER)		
<b>QV</b>	Last Channel Recall			
<b>DEVICE Menu</b>	n/a	Transport Menu redisplay	Transport Menu redisplay	Device Menu
<b>HOME</b>	Exit menus/displays	Exit menus/displays	Exit menus/displays	Exit menus/displays
<b>ENTER</b>	Enter or select	Enter or select	Enter or select	Enter or select
<b>CANCEL</b>	Cancel function	Cancel function	Cancel function or Counter Reset	Cancel function
<b>GUIDE</b>	Digital Channel Guide	Track or program list display	Digital Channel Guide	
<b>ADJUST</b>	up/down left/right	Skip Forward 30 seconds (during playback) Skip Backwards 12 seconds (during playback) Skip to end or beginning of program Page up/down in track list	up/down left/right	up/down left/right
<b>PLAY</b>		Play	Play	
<b>STOP</b>		Stop	Stop	
<b>RECORD</b>		Record	Record	
<b>REW/REV</b>		Reverse picture scan or Slow Play	Reverse or Slow Play	
<b>FF/FWD</b>		Fast picture scan or Fast Play	Fast Play	

# Appendix A: Bypassing the V-Chip Lock:



**Lock Bypass Instructions Have Been Filed for  
Future Reference**

## **Bypassing the V-Chip Lock**

After you set the lock, you need your passcode to view a V-Chip locked program, view the locked TV, cancel the lock, or enter the V-Chip Lock menus.

If you forget your passcode, you can view the locked TV without entering your passcode. This is done by pressing the number 9 and QV buttons on the TV remote control at the same time, when your passcode is requested. This process temporarily unlocks the TV.

When entering the V-Chip Lock menu, this process deletes your old passcode and prompts you to enter a new passcode. Press HOME to exit the menu.

## **Bypassing Front Button Lock**

If you have misplaced the remote control, you can bypass the front button lock by pressing and holding the MENU button on the front panel for more than 8 seconds.

### ***IMPORTANT***

**Cut along the dotted line and file bypass instructions in a safe place for future reference.**

### ***IMPORTANT***

**When changing or deleting your passcode, you must use the remote control included with this TV. You cannot use a Mitsubishi remote control from another component or a "universal" remote.**

**This page intentionally blank**



# Appendix B: Specifications



From time to time, Mitsubishi may offer software updates to expand the features or operation of this TV. When these updates are available they will be announced on our web site, Mitsubishi-tv.com. If you return your Owner's registration card, with your model and serial number, you may receive written notification of available software updates.

<b>TV Specifications</b>	
<b>Projection System</b>	DLP, 0.8" chip, 1280 x 720 pixels
<b>Lamp</b>	120 watt VIP type
<b>Channel Frequency Reception</b>	Over-the-Air: VHF 2 - 13, UHF 14 - 69 Analog Cable: 1 - 125 Digital Cable: 1 - 135
<b>Channel Type</b>	Over the Air: Analog NTSC, Digital ATSC with sub-channels (all 18 video formats) Cable: Analog NTSC (non-scrambled) Digital QAM 64 and 256 with sub-channels (non-scrambled) CableCARD™: Authorized scrambled and non-scrambled digital channels
<p><b>Note for Digital Channels:</b> The channel numbers displayed on-screen are determined by the broadcaster or cable company and can vary from the standard frequency number. If there is no channel number information included from the broadcaster or cable company, then the TV will create a channel number based on the frequency number as the main channel number and the program number as the sub-channel number. When using an authorized CableCARD, the channel numbers are determined by the cable company.</p>	
<b>Inputs</b>	
<b>Antenna/Cable input Qty 2</b>	F connector, 75ohm
<b>HDMI (digital video/audio), Qty 1 Signal Type</b>	HDMI standard connector HDMI standards for digital audio and video. Not intended for use with personal computers
<b>Video/S-Video, Qty 3 each  Signal Type</b>	Video: RCA Pin Plug, 1.0 V p-p, 75 ohm S-Video: Four Pin Din Plug Y: 1.0 Vp-p 75 ohm C: 0.286 Vp-p (burst signal), 75 ohm NTSC 480i only
<b>Component Video (Y/Pr/Pb) Qty 2 sets  Signal Type</b>	RCA Pin Plug (EIA-770.3 Standard Levels and Timing) Y: 1.0 Vp-p (includes sync), 75 ohm Pr: 700 mVp-p, 75 ohm Pb: 700 mVp-p, 75 ohm EIA-770.1 & EIA 770.2 480i, 480p, EIA 770.3 720p and 1080i (video standards)
<b>Input-DTV (Y/Pr/Pb or RGBH&amp;V) Qty 1 set  Signal Type</b>	RCA Pin Plug, When used as Y/Pr/Pb same as component inputs shown above When used as RGBH&V: R (red): 700 mVp-p, 75 ohm G (green - no sync): 700 mVp-p 75 ohm B (blue): 700 mVp-p, 75 ohm H (horizontal sync): 3 Vp-p +/-1.0v, 2.2k-ohm V (vertical sync): 3 Vp-p, +/- 1.0v, 2.2k-ohm EIA-770.1 & EIA 770.2 480i, 480p, EIA 770.3 720p and 1080i (video standards)
<b>PC Input (RGB) Qty 1 Signal Type</b>	Mini-D Sub, 15 pin VGA (640 x 480), 60Hz Some WVGA (848 x 480), 60 Hz might be compatible, but not guaranteed SVGA (800 x 600), 60Hz XGA (1024 x 768), 60 Hz 1280 x 720, 60 Hz (EIA standards)
<b>Audio Inputs: Qty 8 pair</b>	RCA Pin Plug 500mV (full scale), 43kohm



## Appendix B: Specifications, continued

<b>Outputs</b>	
<b>Video</b>	
<b>Video, Qty 1 Signal Type</b>	<b>Video: RCA Pin Plug 1.0 Vp-p, 75 ohm NTSC 480i only</b>
<b>Audio</b>	
<b>Monitor Output, Qty 2 pair</b>	<b>RCA Pin Plug, 500 mV rms <math>\pm</math> 200 mV (full scale) for analog sources. 1.5 V <math>\pm</math> 0.5 V (full scale) for digital sources.</b>
<b>Digital Interfaces:</b>	
<b>Digital Audio Output, Qty 1</b>	<b>RCA Pin Plug, Signal Type, Dolby Digital</b>
<b>IEEE 1394, Qty 3</b>	<b>IEEE 1394 Four Pin type Terminal, S400</b>
<b>Audio/Speakers</b>	<b>10 watt x 2, 5" coaxial speakers</b>
<b>Dimensions</b>	
<b>WD-52825</b>	<b>H 37-1/4" x W 49-5/8" x D 17-3/8", 132lbs</b>
<b>WD-62825</b>	<b>H 43-5/8" x W 58-5/16" x D 19-7/8", 165 lbs</b>
<b>Power Consumption</b>	<b>275 watts</b>
<p><b>Net command® IEEE 1394 System Compatibility:</b> This television is designed to conform to IEEE 1394 AV/C Software standards in effect at the time of development. This exciting new networking and control technology is designed to provide high-performance digital connections and product control, making the product easier to use.</p> <p>Mitsubishi D-VHS VCRs are fully compatible with this TV in audio, video and control. Many DV camcorders that have IEEE 1394 connections will be compatible with the control features of this TV, but not compatible with the audio or video decoder.</p> <p>As other manufacturers distribute products that use the IEEE 1394 AV/C standards, they will be responsible for developing products that meet the standards of the technology, as well as compatibility testing with other products. Mitsubishi cannot be responsible for their efforts, and therefore cannot promise compatibility with these other products. Any compatibility problems with other manufacturers products should be brought to the attention of those manufacturers.</p> <p>The HDMI input is compliant with EIA-861B standards for standard, extended and high definition video, digital audio and HDCP copy protection. However, this input is not intended for use with personal computers or devices outputting video signals with computer resolutions.</p>	

# Appendix C: Remote Control Programming Codes



## IMPORTANT

The remote control may return to its initial setting when the batteries are changed. You may need to reprogram.

## Programming the Remote to Control NetCommand A/V Products

1. Move the slide switch at the top of the remote to the TV position.
2. Press and hold POWER on the remote control.
3. Enter the three digit code of 935, and then release POWER.
4. When the remote control is in the TV position, it is now programmed to send NetCommand signals to the TV so the TV can control the IEEE 1394 devices and older NetCommand supported or learned IR devices.

(This is the default setting for the remote control.)

## Programming the Remote to Control Other Brands of Audio and Video Products

1. Move the slide switch at the top of the remote to the product you want to control.
2. Press and hold POWER on the remote control.
3. Enter the first three digit code listed for your equipment, and then release the POWER button on the remote control.
4. Point the remote control at the equipment and press the POWER button. If the equipment responds, the remote control is properly programmed to operate the equipment. If the equipment does not respond, repeat steps 2-4 with the next three digit code listed in step 3 for your equipment.

## A/V Receivers

A/V Receiver Brand	Code
MITSUBISHI	010, 011, 012, 013, 014
AIWA	225, 226, 241
BOSE	351
B&K	352
DENON	234, 235, 236, 245, 246, 359, 361
FISHER	204
GARRARD	213
HARMAN KARDON	215, 223, 242, 362
JENSEN	223, 229
JVC	232, 233
KENWOOD	200, 208
KLH	363
KOSS	357
MAGNAVOX	227, 228
MARANTZ	224, 350, 360
MCINTOSH	216
NAKAMICHI	206, 217
ONKYO	209, 214, 240, 247
OPTIMUS	203, 227, 231, 230
PANASONIC	219, 218, 221
PARASOUND	356
PHILIPS	223, 248
PIONEER	205, 207
POLK AUDIO	353
QUASAR	219, 218, 221
RCA	203, 205, 227, 231, 230
ROTEL	366
SANSUI	203, 211, 239
SHARP	234, 237
SHERWOOD	354, 355
SONY	222, 249, 364, 365
TEAC	212, 213, 211, 210
TECHNICS	221, 218, 219
VICTOR	232, 233
YAMAHA	201, 202, 243, 244

## Cable Boxes

Cable Brand	Code
ABC	124
ARCHER	125
CABLEVIEW	105,
CITIZEN	122, 105
COLOR VOICE	128, 129, 130, 106, 107
COMTRONICS	128, 129, 130, 106, 107
CURTIS	112, 113
DIAMOND	124, 125
EAGLE	129
GCBRAND	105
GE	112, 113
GEMINI	122
GENERAL INSTRUMENT/	119, 123, 124, 125, 126, 127, 120,
JERROLD	121, 122
HAMLIN	112
HITACHI	103, 124
MACOM	103, 104, 105, 108
MAGNAVOX	128, 129, 130, 106, 107, 133, 138
MOTOROLA	123, 146
MEMOREX	130
MOVIE TIME	105,
PANASONIC	114
PARAGON	117
PHILIPS	128, 129, 130, 106, 107, 131, 133,
	138
PIONEER	101, 106, 116
PULSAR	105
RCA	115
REGAL	112
REMBRANDT	105, 138
SAMSUNG	105
SONY	147, 177
ZENITH/DRAKE SATELLITE	100



# Appendix C: Remote Control Programming Codes, continued

## Cable Boxes, continued

SCIENTIFIC ATLANTA	112, 113, 194
SIGNATURE	119,124,125,126,127,120,121,122
SLMARK	105,101
SPRUCER	105
STARCOM	119,124,125,126,127,120,121,122
STARGATE	105
TELEVIEW	101,105
TOCOM	135,136
TOSHIBA	104
UNIKA	125
UNITED CABLE	119,124,125,126,127,120,121,122
UNIVERSAL	122
VIDEOWAY	106
VIEWSTAR	129,130
ZENITH	117,100

## DVD Players

DVD Brand	Code
DAEWOO	030, 031
DIMENSIA	065
EMERSON	063, 046, 038, 039, 023, 045, 062, 040
FISHER	025, 028, 029, 027
FUNAI	047, 046, 040
GE	053, 065, 044, 079
GO VIDEO	057, 069, 070, 071
GOLDSTAR	026
HITACHI	043, 065, 020, 047
INSTANT REPLAY	044, 043
JVC	030, 031, 076, 077
KENWOOD	030, 026, 031
LXI	047, 026, 020, 027, 028, 025, 029
MAGNAVOX	051, 043, 044
MARANTZ	030, 031
MARTA	026
MEMOREX	044, 029
MGA	060, 067, 068, 061, 062
MINOLTA	020, 065
MULTITECH	067, 047
NEC	030, 031
OLYMPIC	044, 043
OPTIMUS	048, 041, 055, 026
ORION	046, 040
PANASONIC	043, 044, 041, 042
PENNEY	044, 020, 065, 025, 030, 031
PENTAX	020, 031, 065
PHILCO	051, 044, 047, 043, 046, 040, 063
PHILIPS	051, 043, 044
PIONEER	043
PROSCAN	065, 020, 043, 044, 051, 066, 021, 022, 053
QUASAR	041, 042, 043, 044
RADIO SHACK	053, 044, 025, 056, 029, 060, 047
RCA	020, 021, 022, 043, 044, 049, 051, 053, 065, 066
REALISTIC	044, 025, 056, 029, 060, 047
SAMSUNG	057, 022, 053
SANSUI	046, 040
SANYO	025, 029
SCOTT	021, 022, 029, 060, 067, 068, 046, 040
SEARS	025, 026, 027, 028, 020
SHARP	055, 056
SIGNATURE 2000	047, 055
SONY	048, 049, 050, 073, 074, 075
SV2000	047
SYLVANIA	051, 043, 044, 047
SYMPHONIC	047
TASHIRO	026
TATUNG	030, 031
TEAC	030, 047, 031
TECHNICS	041, 042, 043, 044
TEKNIKA	044, 047
TOSHIBA	021, 066
TOTEVISION	026
VECTOR RESEARCH	031
WARDS	055, 056, 029, 064, 026
YAMAHA	025, 030, 031
ZENITH	064, 026

## Satellite Receivers/DBS/DTV

DBS Brand	Code
MITSUBISHI	006 (same as 173)
ECHOSTAR/DISH NETWORK	175, 182, 183, 188
EXPRESS VU	175
G.E.	176
HITACHI	173, 181, 184
HNS(Hughes)	173
JVC (ECHOSTAR)	175
MAGNAVOX	171, 172
PANASONIC	174
PHILIPS	171, 172
PROSCAN	176, 179, 180, 185
RCA	176, 179, 180, 185
SAMSUNG - TERRESTRIAL	192
SONY	177
STAR CHOICE	173
TOSHIBA	170, 189, 190, 191
UNIDEN	171, 172
WEBTV	187
ZENITH/LG	193

## VCRs

VCR Brand	Code
MITSUBISHI	001, 060, 067, 068, 061, 062, 002
AKAI	049, 034, 035, 036
AUDIO DYNAMIC	031
BELL&HOWELL	025,
BROKSONIC	040, 046
CANON	043, 045
CITIZEN	026
CRAIG	025, 049, 026
CURTIS MATHES	065, 044, 047
DAEWOO	063, 021, 044, 078
DBX	030, 031
DIMENSIA	065
EMERSON	063, 046, 038, 039, 023, 045, 062, 040
FISHER	025, 028, 029, 027
FUNAI	047, 046, 040
GE	053, 065, 044, 079
GO VIDEO	057, 069, 070, 071
GOLDSTAR	026
HITACHI	043, 065, 020, 047
INSTANT REPLAY	044, 043
JVC	030, 031, 076, 077
KENWOOD	030, 026, 031
LXI	047, 026, 020, 027, 028, 025, 029
MAGNAVOX	051, 043, 044
MARANTZ	030, 031
MARTA	026
MEMOREX	044, 029
MGA	060, 067, 068, 061, 062
MINOLTA	020, 065
MULTITECH	067, 047
NEC	030, 031
OLYMPIC	044, 043
OPTIMUS	048, 041, 055, 026
ORION	046, 040
PANASONIC	043, 044, 041, 042
PENNEY	044, 020, 065, 025, 030, 031
PENTAX	020, 031, 065
PHILCO	051, 044, 047, 043, 046, 040, 063
PHILIPS	051, 043, 044
PIONEER	043
PROSCAN	065, 020, 043, 044, 051, 066, 021, 022, 053
QUASAR	041, 042, 043, 044
RADIO SHACK	053, 044, 025, 056, 029, 060, 047
RCA	020, 021, 022, 043, 044, 049, 051, 053, 065, 066
REALISTIC	044, 025, 056, 029, 060, 047
SAMSUNG	057, 022, 053
SANSUI	046, 040
SANYO	025, 029
SCOTT	021, 022, 029, 060, 067, 068, 046, 040
SEARS	025, 026, 027, 028, 020
SHARP	055, 056
SIGNATURE 2000	047, 055
SONY	048, 049, 050, 073, 074, 075
SV2000	047
SYLVANIA	051, 043, 044, 047
SYMPHONIC	047
TASHIRO	026
TATUNG	030, 031
TEAC	030, 047, 031
TECHNICS	041, 042, 043, 044
TEKNIKA	044, 047
TOSHIBA	021, 066
TOTEVISION	026
VECTOR RESEARCH	031
WARDS	055, 056, 029, 064, 026
YAMAHA	025, 030, 031
ZENITH	064, 026

# Appendix C: Remote Control Programming Codes, continued



## **IMPORTANT**

Some manufacturers may change their products, or they may use more than one remote control system. If this is the case, the TV remote control may not be able to operate your VCR, DVD, cable box, satellite receiver, or A/V receiver.

After entering the correct codes in each position of the remote control, use the slide switch to select which product will respond when an operational button is pressed. Only one of the below devices is allowed for each slide switch position.

TV position:

- ➡ TV, NetCommand® Controlled Devices

Cable/DBS/DTV position:

- ➡ Cable box
- ➡ Satellite receiver
- ➡ DTV receiver

VCR position:

- ➡ VCR

DVD position:

- ➡ DVD
- ➡ LD Player

Audio position:

- ➡ A/V receiver
- ➡ Mitsubishi CD player

If you have a Mitsubishi A/V receiver, the audio position may be used in conjunction with select Mitsubishi CD players. Your audio position must be programmed to 010.

When your remote control has been programmed to operate another manufacturer's product, the function performed on each layer can vary. The most common functions are:

<p><b>VCR</b></p> <ul style="list-style-type: none"> <li>• POWER</li> <li>• CHANNEL up/down</li> <li>• PLAY</li> <li>• REC</li> <li>• PAUSE</li> <li>• STOP</li> <li>• FF/FWD</li> <li>• REW/REV</li> </ul> <p>Mitsubishi VCRs will be compatible with some additional buttons</p>
<p><b>Cable Boxes and Satellite Receivers</b></p> <ul style="list-style-type: none"> <li>• POWER</li> <li>• CHANNEL up/down</li> <li>• 0-9 number buttons (on some models)</li> <li>• ENTER (on some models)</li> <li>• CANCEL (on some models)</li> <li>• ADJUST up/down/ left/right (on some models)</li> <li>• GUIDE (on some models)</li> </ul>
<p><b>A/V Receivers</b></p> <ul style="list-style-type: none"> <li>• POWER</li> <li>• VOLUME</li> <li>• MUTE</li> </ul>
<p><b>Mitsubishi A/V Receivers</b></p> <ul style="list-style-type: none"> <li>• Direct Input Selection buttons: numbers, SQV and QV (on some models)</li> </ul>
<p><b>Mitsubishi CD Players</b> (not all functions for all models)</p> <ul style="list-style-type: none"> <li>• PLAY</li> <li>• FF/FWD</li> <li>• REW/REV</li> <li>• PAUSE</li> <li>• STOP</li> </ul>
<p><b>DVD and Laser Disc Players</b> (not all functions for all models)</p> <ul style="list-style-type: none"> <li>• POWER</li> <li>• MENU</li> <li>• 0-9 number buttons (on some models)</li> <li>• PLAY</li> <li>• STOP</li> <li>• ARROW up/down/left/right (on some models)</li> <li>• FF/FWD</li> <li>• REW/REV</li> <li>• PAUSE</li> <li>• CANCEL (on some models)</li> <li>• ENTER</li> <li>• CHANNEL (on some models)</li> </ul>



# Appendix D: On Screen Information Displays

When you turn on the TV, change Devices, change Channels or when you press the INFO button on the remote control the TV will display the current status. Below are the most common displays; please note that seldom or never do all of the different status indicators appear at the same time.

## Analog Program

1. Antenna or Device being viewed
2. Analog channel being received: If antenna being viewed
3. Channel name (if manually programmed)
4. Signal Type being received  
**Possible:**  
Ant-1, Ant-2 or Input 1-3 – 480i  
Component 1, 2 – 480i, 480p, 720p or 1080i  
Inp-DTV – 480i, 480p, 720p or 1080i
5. Screen format being used  
**Possible:**  
Analog 480i/480p signals – Standard, Expand, Zoom, Stretch, Stretch Plus, Narrow  
720p/1080i signals - Standard, Wide Expand
6. Stereo and/or SAP being broadcast
7. V-Chip Ratings
8. Channel in SuperQuickView bank 2
9. Day and Time
10. Sleep Timer remaining time
11. PIP source and channel
12. Special Message Line  
(shows only when a special message is needed)

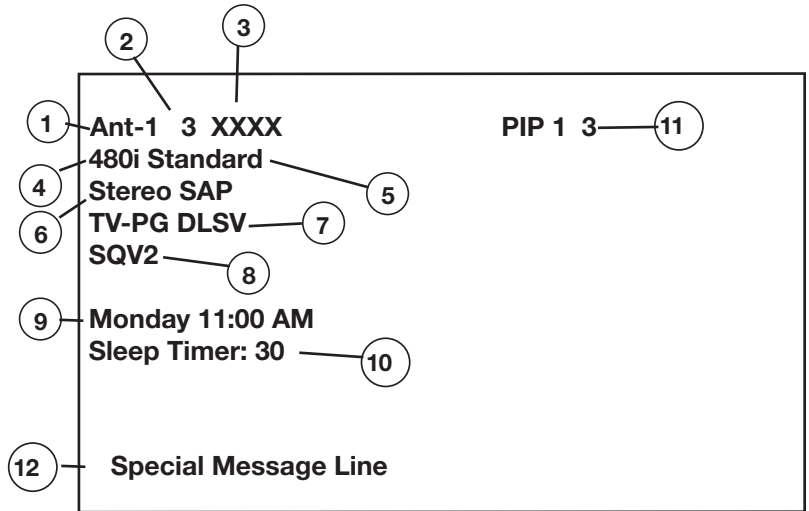

## Digital Program

1. Digital Major and Sub channel number
2. Digital Channel Name (only if broadcast)
3. Signal Type being broadcast/received  
**Possible:** SD 4:3, SD 16:9 or HD
4. Screen format being used  
**Possible:**  
SD 4:3 - Standard, Expand, Zoom, Stretch, Stretch Plus, Narrow  
SD 16:9 or HD - Standard, Wide Expand
5. Language(s) being broadcast
6. Program Name (if broadcast)
7. Special Message Line  
(shows only when a special message is needed)

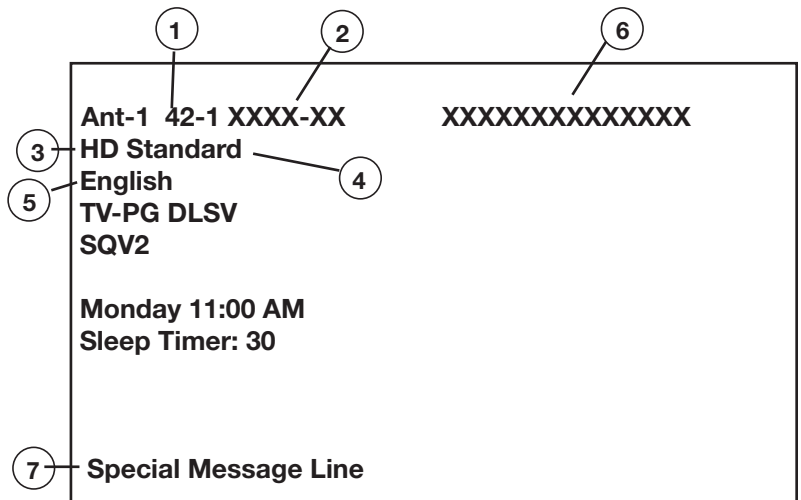

## Digital IEEE 1394 Device

1. Status of D-VHS VCR or IEEE 1394 device
2. Counter of D-VHS VCR
3. Media type in D-VHS VCR
4. Special message line  
(shows only when a special message is needed; may be seen with Analog signals)

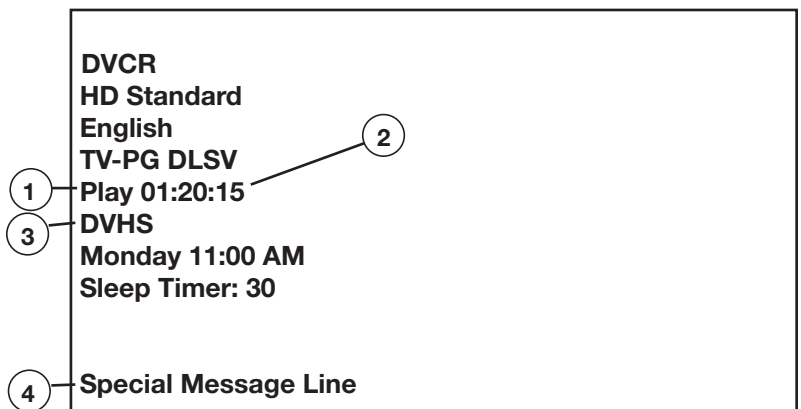

# Appendix E: NetCommand® Specialized Device Keys



A/V RECEIVER	CABLE or DBS	VCR	DVD	LEARNING SCREEN CHECKBOX NAME	FUNCTION	NAME ON TV REMOTE
X	X	X	X	Power*	Power On or Power On/Off	POWER**
X	X	X	X	Power (Off)*	Power Off	POWER**
X				Volume Up	Volume Up	VOL ▲
X				Volume Down	Volume Down	VOL ▼
X				Mute	Mute	MUTE
X				Analog to Digital*	Analog/Digital Switch	GUIDE**
X				Digital to Analog*	Digital/Analog Switch	GUIDE**
X				Input (1-7)	AVR Input Select	Automatic (when device is selected)
	X	X		Channel Up	Channel Scan Up	CHAN ▲
	X	X		Channel Down	Channel Scan Down	CHAN ▼
	X			Recall	Last Channel Recall	QV
	X		X	Guide	Guide	GUIDE
	X	X	X	Adjust Up	Arrow/ move Up	ADJUST ▲
	X	X	X	Adjust Down	Arrow/ move Down	ADJUST ▼
	X	X	X	Adjust Left	Arrow/ move Left	ADJUST ◀
	X	X	X	Adjust Right	Arrow/move Right	ADJUST ▶
	X	X	X	Enter	Enter/Select	ENT
	X	X	X	Menu	Device Menu or Setup Menu	DEVICE MENU
	X	X	X	Cancel	Cancel or Exit	CANCEL
	X	X	X	Info	Status Information Display	INFO
	X			Page Up	Guide Page Up	CHAN ▲ ***
	X			Page Down	Guide Page Down	CHAN ▼ ***
	X	X	X	Play	Play	PLAY
	X	X	X	Stop	Stop	STOP
	X	X	X	Forward	Fast Forward/Fwd Search	FF
	X	X	X	Rewind	Rewind/Reverse Search	REW
	X	X	X	Pause	Pause	PAUSE
	X	X	X	Record	Record	REC
	X	X	X	Enter (digits)†	Enter for channel numbers	ENT
	X	X	X	Low Speed Out*	LowSpeed 480i out	FORMAT**
	X	X	X	High Speed Out*	Hi Speed 480p/1080i out	FORMAT**
	X	X	X	1,2,3,4,5,6,7,8,9,0	1,2,3,4,5,6,7,8,9,0	1,2,3,4,5,6,7,8,9,0
	X	X		Input	Input Change	GUIDE**
		X		Sub channel separator‡	Digital Sub channel	CANCEL
			X	Chapter +	Chapter Skip Forward	CHAN ▲
			X	Chapter -	Chapter Skip Reverse	CHAN ▼

\* These are paired functions (e.g. Power and Power Off). When the original remote control uses a single button for both functions, learn only the first of the paired functions.

† If there are two Enter keys, learn the Enter key used for channel selection here. The ENT button on the remote sends the correct IR code when digits are entered.

‡ Learn the subchannel separator if a special key is used to add a separator (dash or dot) in a digital channel. Press the CANCEL button on the remote to add the separator

\*\* This function is performed only when the Device Selection Menu is displayed and the device icon is highlighted.

\*\*\* Channel Up/Down as Guide Page Up/Down happens only after pressing GUIDE and returns to channel functions after pressing ENTER or CANCEL.



## Appendix F: Cleaning and Service

### **IMPORTANT**

**DO NOT use any kind of abrasive cleaner on the surface of the TV screen or Diamond Shield™.**

### **Cleaning**

Normally, light dusting with a dry, non-scratching duster will keep your TV clean. If cleaning beyond this is needed, please use the following guidelines:

First, turn off the TV and unplug the power cord from the power outlet.

### **Top and Sides of the TV:**

- Gently wipe down your TV with a soft, non-abrasive cloth such as cotton flannel or a clean cloth diaper, lightly moistened with water. Dry with a second dry, soft, non-abrasive cloth.
- For oily dirt, add a few drops of mild liquid detergent, such as dishwashing detergent to the water used to moisten the cloth. Rinse with a second cloth moistened only with water. Dry with a third dry, soft, non-abrasive cloth.

### **Diamond Shield™:**

- Clean with a soft non-abrasive cloth moistened with water only.

### **Screen behind the Diamond Shield:**

- Follow the instructions for the top and sides, however, wipe gently in an up and down motion, following the grooves in the screen.
- Clean the entire screen evenly, not just sections of the screen.
- Do not allow liquid to drip down the grooves of the screen as some liquid may enter the TV between the screen and the screen frame.
- You may purchase Mitsubishi Screen Cleaner, part number CLEANER-VSS, by calling (800) 553-7278.

### **General Cleaning Warnings:**

- DO NOT allow liquid to enter the TV through the ventilation slots or any crevice.
- DO NOT use any strong or abrasive cleaners as these can scratch the surfaces.
- DO NOT use any cleaners with ammonia, bleach, alcohol, benzene, or thinners as these can dull the surfaces.
- DO NOT spray liquids or cleaners directly on the TV's surfaces.
- DO NOT scrub or rub the TV harshly. Wipe it gently.

### **Service**

If you are unable to correct a problem with your TV, consult your Mitsubishi dealer or a Mitsubishi Authorized Warranty Service Center.

- DO NOT adjust any controls other than those described in this Owner's Guide.
- DO NOT remove the protective back cover of your TV.

Menus not described and shown in this owner's guide are designed for Factory use and for Authorized Service Personnel. Damage caused to the TV by non-authorized changes or changes to these menus made by non-authorized persons are not covered under warranty.



# Appendix G: Diamond Shield™ Removal



The Diamond Shield is installed by the factory to enhance your television viewing experience. If you want to remove the Diamond Shield, please follow the steps listed below:

## To Remove the Diamond Shield:

1. While wearing soft cotton gloves, loosen the sides of the Diamond Shield by pressing a small plastic card (the size of a standard credit card or a clean, plastic, putty knife) into the middle of the side slot. The Diamond Shield side will snap out of the top middle and bottom clips. Loosen both sides before proceeding to step 2.
2. After the sides are free, gently push down on the top of the Diamond Shield. It will slide out of the top channel.
3. Carefully pull the screen up to remove it from the bottom channel. Store the Diamond Shield in a clean, dust free area, where it will not be scratched.



## To Install the Diamond Shield:

4. Slide the Diamond Shield into the bottom channel, making sure it fits securely.
5. Press gently on the top of the Diamond Shield to slightly bow the screen towards you. Insert the top of the Diamond Shield into the top channel. It should fit securely.
6. At each side, gently press the top, middle and bottom of the Diamond Shield to snap it back into place.

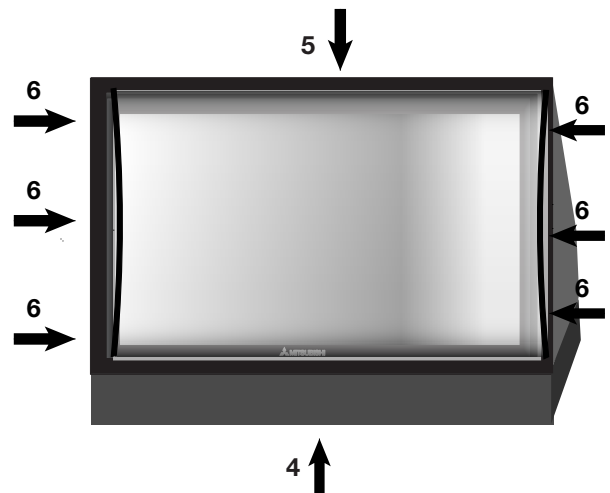

### WARNING

**Sharp edges! Always wear gloves to handle, lift, install and remove the Diamond Shield.**

### IMPORTANT

For further assistance, call  
(800) 332-2119.

# Appendix H: Filter Cleaning

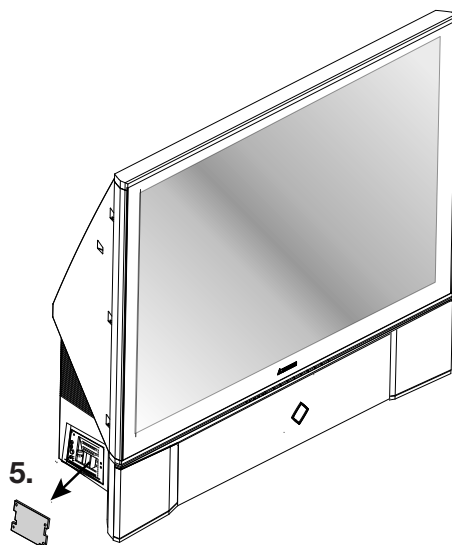
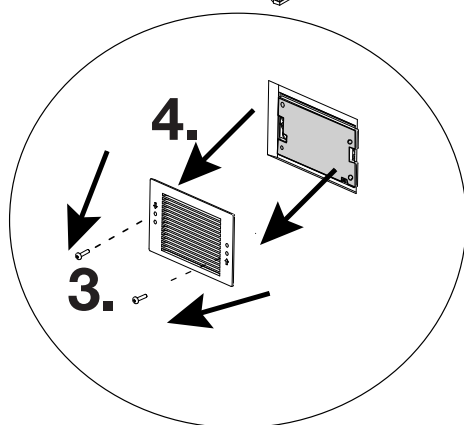
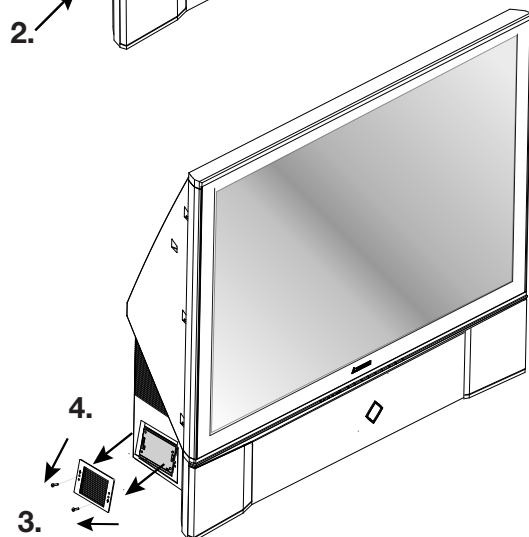
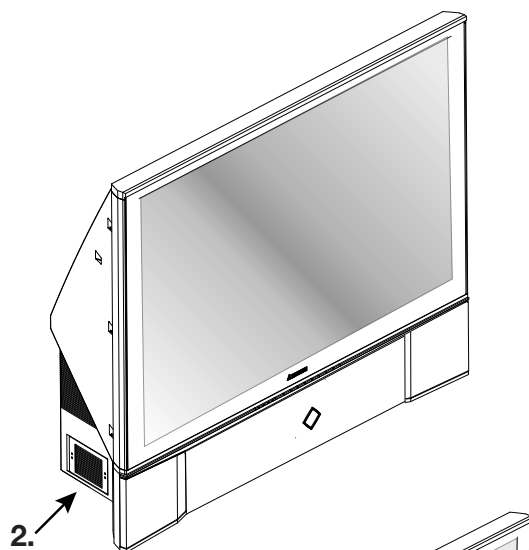

## Cleaning the Dust Filter

***Clean the filter annually and whenever you replace the lamp cartridge.***

**Tools needed: Phillips screwdriver**

1. Turn the television off and unplug the AC cord.
2. Locate the dust filter on the left side panel of the TV.
3. Using a phillips screwdriver, remove the two screws that hold the dust filter cover in place.
4. Remove the filter cover, set it and the screws aside.
5. Carefully remove the filter from the TV.
6. Clean the filter material by dusting with a lint-free cloth.
7. If the filter is soiled, you can rinse it with water. Do not use detergents or soap on the filter.
8. Completely air dry the filter before placing it back into the TV.
9. Replace the filter cover and secure with the screws.

# Appendix H: Lamp Cartridge Replacement



Before you replace the lamp cartridge please note the following:

**CAUTION: If the television is on, press POWER to turn off and allow the television to cool for one hour before attempting to replace the lamp cartridge.**

## LAMP LIFE

The light source for this television is a lamp, which is part of a lamp cartridge assembly. The actual life of the lamp in this television can vary, based on the lamp itself, the air temperature around the TV while it is operating, and your viewing patterns. Warmer air or poor ventilation shortens the lamp life, as does turning the television on and off frequently.

Mitsubishi warrants the lamp for one (1) year from date of the original purchase at retail. However, it is likely that the lamp will last significantly longer than this. When the end of the lamp's life is approaching, the TV will display a warning message for one minute, when the TV is powered on. The purpose of this message is to advise you that the lamp may fail soon. This warning message will continue to be displayed every time the TV is turned on, until the lamp cartridge is replaced and the lamp's status is reset.

After replacing the lamp cartridge, when you power on the TV, the message "Did you change the lamp? Press ENTER for Yes, press CANCEL for No" will appear, press ENTER to reset.

To order a new lamp cartridge, please call (800) 553-7278 and order part number 915P020010.

## **WARNING:**

Do not remove the lamp cartridge immediately after turning off the television. You may get burned because of the lamp's high temperature. Allow the television to cool for one hour before attempting to replace the lamp cartridge.

Do not remove the lamp cartridge, except when replacing. Careless treatment can result in injury or fire.

Do not touch the lamp element directly. It may break and cause you to have injuries or burns.

Be sure not to insert any metal or flammable object into the lamp cartridge opening, as it may cause fire or electrical shock. If any object is inserted into the opening unplug the AC cord of the TV and contact your dealer for service.

Install the lamp cartridge securely. Failure to do so may cause a fire.

The lamp in this product contains mercury. Disposal of mercury may be regulated due to environmental considerations. For disposal or recycling information, please contact your local authorities or the Electronic Industries Alliance: [www.eiae.org](http://www.eiae.org)



## Appendix H: Lamp Cartridge Replacement, continued

### Replacing the Lamp Cartridge

**Tool needed: Phillips screwdriver**

1. Turn the television off and unplug the AC cord.
2. Open the front panel by pressing in the center of the glossy panel, above the diamond. The panel will lower and you can access the lamp cartridge.
3. Using a phillips screwdriver, remove the three screws (one on the left and two on the right side) that hold the recessed plastic cover in place.
4. Remove the plastic cover and set aside with the screws.
5. After removing the cover, you will be able to see the lamp cartridge. With the screwdriver, loosen the three screws of the cartridge.

**The three screws will not completely remove .**

6. Gently grasp the metal handle and pull straight out (towards you).
7. Insert the new lamp cartridge securely into the TV. Do not touch the glass surface of the cartridge.
8. With the screwdriver, tighten the screws on the lamp cartridge.
9. Replace the plastic cover and screws.
10. Close the front panel by pushing it back into place.

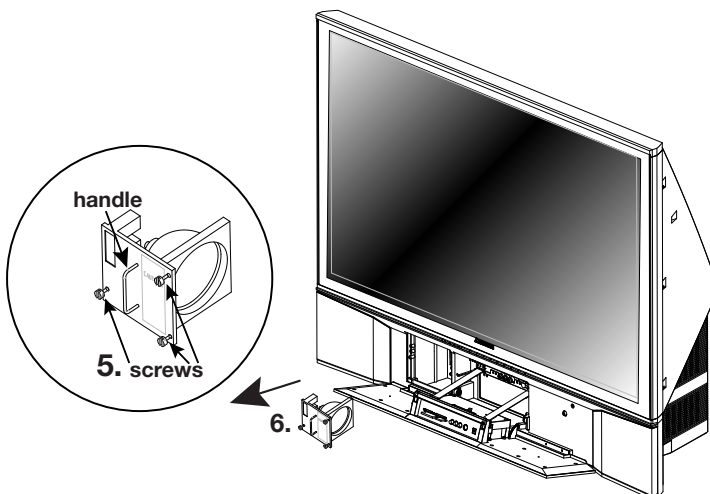
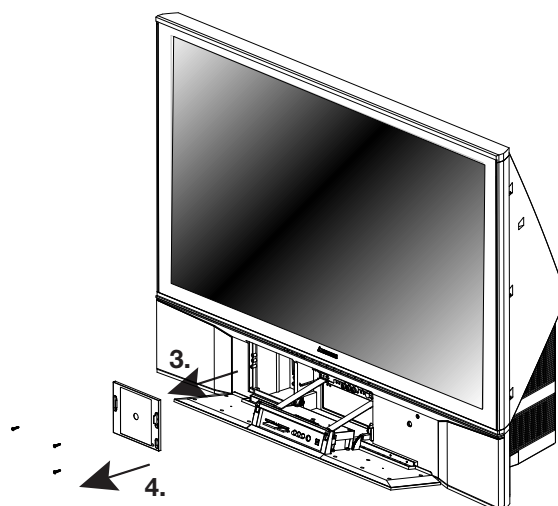
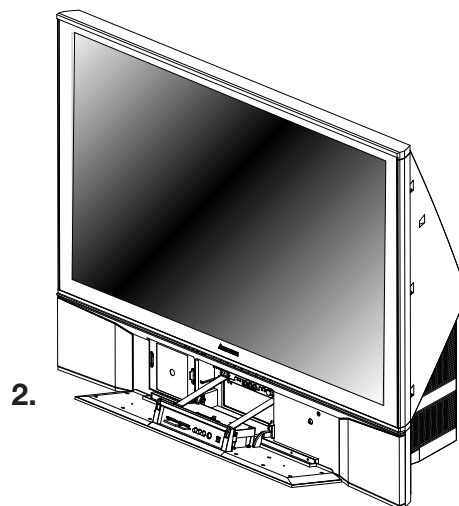

**To order a replacement lamp cartridge, part number 915P020010, call (800) 553-7278.**

# Troubleshooting

	Problem	Possible Solution
1.	The TV remote control does not work.	<ul style="list-style-type: none"> <li>• Check that the batteries are installed correctly.</li> <li>• Check that the selected switch is set to "TV".</li> <li>• Be no further than 20 feet from the TV when using the remote control.</li> <li>• Program the remote control to operate the TV (Appendix C).</li> </ul>
2.	The TV takes several seconds to respond.	<ul style="list-style-type: none"> <li>• It is normal for digital channels to take longer to tune in.</li> <li>• Press ENTER after a channel number to avoid delays.</li> <li>• Use a 4 digit number for an over-the-air digital channel</li> <li>• Use a 6 digit number for cable digital channels</li> </ul>
3.	Cable provider needs information to start CableCARD™ service.	<ul style="list-style-type: none"> <li>• On the remote control, press TV MENU and then enter the numbers 999 to display the Host ID and CableCARD™ ID information.</li> </ul>
4.	You cannot access a channel.	<ul style="list-style-type: none"> <li>• Use number keys instead of CHANNEL up/down.</li> <li>• Be sure the channel you want to view is in memory. See page 65.</li> <li>• Check that the TV is turned to the correct device or antenna for that channel, by pressing the DEVICE button.</li> <li>• Make sure the V-Chip lock is off.</li> <li>• If tuned to Digital channels, have physical channel in memory.</li> </ul>
5.	On-screen displays appear each time you change a function.	<ul style="list-style-type: none"> <li>• This is part of normal TV operation.</li> </ul>
6.	You cannot program the TV to turn on automatically (timer function)	<ul style="list-style-type: none"> <li>• The TV may be locked.</li> <li>• The clock may not be set.</li> </ul>
7.	There is no sound even when the volume is turned up.	<ul style="list-style-type: none"> <li>• Check audio source in Device Menu.</li> <li>• Check to see if the MUTE button is on.</li> <li>• The TV's "Listen to:" setting may be set to SAP.</li> <li>• Check that the "TV Speakers" setting is On in the Audio/Video menu.</li> </ul>
8.	NetCommand unable to learn specific device keys.	<ul style="list-style-type: none"> <li>• Device does not use IR format for remote control signal. ITT and RF formats cannot be learned.</li> <li>• Room lighting may affect the signal. Have the remotes very close (6 inches or less) to the TV during Learning.</li> <li>• If using a Mitsubishi remote control make sure slide switch is not set to TV position.</li> <li>• Some but not all device key functions can be learned by NetCommand. For example, POWER and PLAY may be learned, but other functions may not.</li> <li>• The signal from the remote control may not be strong enough. Insert fresh batteries and try Learning again.</li> </ul>
9.	You have forgotten your V-Chip passcode.	<ul style="list-style-type: none"> <li>• See Appendix A, Bypassing the V-Chip Lock.</li> </ul>
10.	Lamp indicator light is a constant red.	<ul style="list-style-type: none"> <li>• Turn the TV off for at least 2 minutes. Turn back on. If light is still red, the lamp has failed, replace it. See Appendix H for lamp replacement information.</li> </ul>
11.	Lamp indicator light is a constant yellow.	<ul style="list-style-type: none"> <li>• Lamp may fail soon. Purchase a new lamp. See Appendix H for lamp replacement information.</li> </ul>
12.	Lamp indicator light is a flashing yellow.	<ul style="list-style-type: none"> <li>• Lamp cover door is open or lamp cartridge is not secure. See Appendix H for lamp replacement information.</li> </ul>
13.	Status indicator light is a constant yellow.	<ul style="list-style-type: none"> <li>• Operating temperature or room temperature has exceeded proper levels. Clean the TV's dust filter or cool the room. See Appendix H for filter cleaning information.</li> </ul>
14.	Status indicator light is a constant/flashing red.	<ul style="list-style-type: none"> <li>• Service is required. Contact your dealer or a Mitsubishi Authorized Service Center to arrange for a service evaluation listings of Mitsubishi Authorized Service locations can be obtained from our web site, <a href="http://www.mitsubishi-tv.com">www.mitsubishi-tv.com</a> or by calling 1-800-332-2119.</li> </ul>
15.	PIP does not display a picture.	<ul style="list-style-type: none"> <li>• Make sure the V-Chip lock is off.</li> <li>• Not all inputs can be displayed as a PIP.</li> </ul>
16.	Digital channels do not appear in PIP.	<ul style="list-style-type: none"> <li>• Normal PIP operation.</li> </ul>
17.	Not all channels appear in multiple PIP/POP.	<ul style="list-style-type: none"> <li>• Digital channels do not display in PIP/POP.</li> </ul>

# Troubleshooting, continued

	Problem	Possible Solution
18.	The sound does not match the screen picture.	<ul style="list-style-type: none"> <li>• NetCommand® is setup incorrectly.</li> <li>• The TV's "Listen to:" setting may be set to SAP.</li> <li>• If using stereo or A/V receiver speakers, check their input selection.</li> <li>• If using stereo or A/V receiver, check that AUDIO 2 of MONITOR OUTPUT on TV's back panel is connected to the A/V receiver.</li> </ul>
19.	There is a large black or gray rectangle on the screen.	<ul style="list-style-type: none"> <li>• The TV's analog closed captioning has been set to "text" mode in the Captions menu. Turn off because there is no text information being broadcast.</li> </ul>
20.	You cannot see a picture when playing a VHS tape.	<ul style="list-style-type: none"> <li>• Display the Device Selection menu and select the correct VCR.</li> <li>• Check your VCRs owner's guide for further trouble shooting.</li> </ul>
21.	V-Chip is not working.	<ul style="list-style-type: none"> <li>• Make sure that V-Chip is On.</li> <li>• If V-Chip Hours are currently set to disable the V-Chip lock, the V-Chip will not block programming.</li> </ul>
22.	The TV will not turn on after being plugged in.	<ul style="list-style-type: none"> <li>• If green light on front panel is blinking, wait for at least one minute for the light to turn off, then press Power again.</li> </ul>
23.	TV functions do not respond to the remote control or to front panel control and will not Power Off.	<ul style="list-style-type: none"> <li>• Use the System Reset button as explained at the end of this section.</li> </ul>
24.	Name options not available for some channels	<ul style="list-style-type: none"> <li>• Only memorized analog channels can be named.</li> </ul>
25.	When viewing a stopped VCR, white lines are rolling on the screen.	<ul style="list-style-type: none"> <li>• Turn off video mute for the VCR.</li> <li>• Begin playing the tape.</li> <li>• Change the VCR input to the antenna input.</li> </ul>
26.	TV turned itself Off and the light on the Front Panel started to blink.	<ul style="list-style-type: none"> <li>• Momentary power fluctuation caused the TV to turn off to prevent damage. Wait for the green light to stop flashing and turn On again.</li> <li>• If the TV does not stay turned On, use the System Reset button. If this happens frequently, obtain an AC line power conditioner/surge protector.</li> </ul>
27.	When a Device is selected from the Device Selection menu, the screen is blue (no signal source).	<ul style="list-style-type: none"> <li>• Make sure the selected device is turned on.</li> <li>• From the Edit NetCommand® menu select Review setting. Verify that the inputs are actually connected to the TV . If they are not, either change the physical connections on the back panel, or select the Change setting on the Edit NetCommand menu to change the TV NetCommand's settings for the connection.</li> </ul>
28.	The Device does not respond to button presses from the remote.	<ul style="list-style-type: none"> <li>• Remote has not been setup for NetCommand® use.</li> <li>• The incorrect manufacturer was selected during setup. Select the Change setting from the Setup menu and then the device to display the manufacturer selection. Change if necessary.</li> <li>• The device is not supported and keys have not been learned.</li> <li>• The requested function is not supported by NetCommand. Verify that the function is supported or keys are learned.</li> <li>• The IR emitter is incorrectly placed. Make sure the IR emitter is facing the IR sensor in the device.</li> <li>• The IR emitter is not plugged into the IR emitter Output NetCommand.</li> <li>• The IR emitter is facing the TV screen, causing double signals. Be sure that the IR emitter cannot send to the TV.</li> </ul>
29.	The A/V Receiver is the selected audio source but there is no sound.	<ul style="list-style-type: none"> <li>• Check to see if the A/V Receiver power is turned on. After the power is turned on, redisplay the Device Selection menu and press ENTER to allow NetCommand to correctly select the A/V Receiver input.</li> <li>• From the Setup Menu select Review setting. Check the Review screen to see if the A/V Receiver inputs and device correspond to the actual connections on the A/V Receiver. If they do not match, either change the actual connections, or select Change on the Edit NetCommand menu to change the device on the Connection screen.</li> </ul>

## Troubleshooting, continued

	Problem	Possible Solution
30.	The TV Speaker icon or A/V Receiver icon is grayed out and not selectable.	<ul style="list-style-type: none"> <li>• Select the Change setting from the Edit NetCommand menu, and then select the device (for example VCR). Once the Connection screen is displayed, check if the audio checkbox is selected for the TV input and/or AVR input.</li> </ul>
31.	Devices are grayed out in the Device Selection menu or the PIP Selection menu.	<ul style="list-style-type: none"> <li>• A recording is in progress requiring the use of Monitor Out. Cancel the recording to select the device.</li> <li>• Digital channels and media cards cannot display in the PIP or POP.</li> </ul>
32.	Cannot see the A/V Receiver menu.	<ul style="list-style-type: none"> <li>• The A/V Receiver is not connected to any input of the TV. To check the A/V Receiver menu temporarily plug into an unused input of the TV. Then select Review from the Setup Menu, turn the input On to view the A/V Receiver menu.</li> </ul>
33.	Screen is black when trying to view digital channels or IEEE 1394 device.	<ul style="list-style-type: none"> <li>• The PerfectColor™ color balance has been incorrectly set. Use the Advanced menu to reset the color balance.</li> </ul>
34.	The REC button is not working, or, on the Transport menu the record key is grayed out and not available.	<ul style="list-style-type: none"> <li>• The device does not support recording, such as a DVD player.</li> <li>• Recordings can not be initiated from the Transport menu when using an IEEE 1394 device. Press REC instead. The Record menu displays allowing setup of a recording.</li> </ul>
35.	A program recorded on your TV is distorted when played on a 4:3 TV.	<ul style="list-style-type: none"> <li>• TV was set to Anamorphic when program was recorded. Record programs in Cropped mode if playing back on a 4:3 TV.</li> </ul>
36.	Excessive digital artifacts.	<ul style="list-style-type: none"> <li>• The IEEE 1394 cable is too long (15 feet between devices is the maximum length).</li> <li>• There may be a slow device in the middle of the IEEE 1394 network. Move the slow devices to the end so that connections for faster devices do not pass through them.</li> </ul>
37.	Cannot see a picture from a DV Camcorder.	<ul style="list-style-type: none"> <li>• Go to Device Selection menu and select analog connection.</li> <li>• Connect the DV Camcorder to analog input (for example, Input-3). Select Setup from the main menu, then Change. At the Change screen, select the camcorder. On the Name screen, check Analog Connection. Select the device and on the following screen, select which analog input was used, and check audio and/or video.</li> </ul>
38.	DVCR analog/digital problems.	<ul style="list-style-type: none"> <li>• If the tape is currently playing but no picture displays, there may be a mismatch of the media with the display. Press DEVICE to display the Device Selection menu. Press ENTER for the DVCR device. If digital is selected, try analog, or if analog is selected, try digital.</li> </ul>
39.	D-VHS recordings for digital cable have drop-outs (loss of picture or sound), or no playback.	<ul style="list-style-type: none"> <li>• Digital cable signals on IEEE 1394 can exceed the data rate standards supported by DVCR.</li> </ul>
40.	There is no audio and video from the IEEE 1394 device.	<ul style="list-style-type: none"> <li>• The device is not turned on - turn the device power on.</li> <li>• No media (tape or disc) is inserted into the device.</li> <li>• The media is blank (has no recording).</li> <li>• The play command failed - Try pressing play again on the device's remote control or front panel.</li> <li>• The device is already in use (for example: the device is currently recording).</li> <li>• The source is copy-protected or violates copy protection.</li> <li>• The device's digital video signal is not supported by the TV, such as DV video, common with camcorders. Use analog connections instead, if available.</li> <li>• The device is not an audio/video device.</li> <li>• Too many other devices are already communicating over IEEE 1394. Remove or stop some devices and try again.</li> </ul>
41.	The IEEE 1394 Device is not listed in the Device Selection menu.	<ul style="list-style-type: none"> <li>• The device is unchecked in the Review screen. Select the NetCommand menu. Through Review, verify the device is checked.</li> <li>• The IEEE 1394 plug is disconnected or loose.</li> <li>• The IEEE 1394 Device has not been powered On. Turn on.</li> <li>• The device has not been discovered.</li> <li>• The device is not an Audio/Video device</li> </ul>

# Troubleshooting, continued

	Problem	Possible Solution
42.	The IEEE 1394 device cannot be selected.	<ul style="list-style-type: none"> <li>• The device may be busy, either recording or a peer-to-peer connection has been established. Cancel the recording or peer-to-peer connection.</li> </ul>
43.	DEVICE MENU button does not display a menu.	<ul style="list-style-type: none"> <li>• The IEEE 1394 device does not provide a menu.</li> <li>• The TV cannot support IEEE 1394 menus. See page 46.</li> </ul>
44.	All IEEE 1394 devices disappear.	<ul style="list-style-type: none"> <li>• The connected devices must not be in a loop that returns to the TV. Make sure a device is connected at the end.</li> <li>• Disconnect all the cables and devices from the TV. Replace them one by one to locate the problem device or cable.</li> <li>• Use System Reset (front control panel).</li> </ul>
45.	Cannot rediscover a deleted IEEE 1394 device	<ul style="list-style-type: none"> <li>• The device has been disconnected. Plug it in.</li> <li>• The device is unchecked in the Review screen. Select NetCommand from the Main menu, then select Review. Check the device.</li> <li>• Remove IEEE 1394 plug. Go to the Edit NetCommand menu. Delete the IEEE 1394 device. Plug the device in again so it can be discovered again.</li> </ul>
46.	An IEEE 1394 device has been plugged in but does not appear in the Device Selection menu (not discovered).	<ul style="list-style-type: none"> <li>• The IEEE 1394 connection to the TV or another device is not secure or is loose.</li> <li>• The IEEE 1394 device is not powered on.</li> <li>• A device in the IEEE 1394 chain is not powered on - turn on all the devices.</li> <li>• The device discovery can take as long as a minute to initiate.</li> <li>• IEEE 1394 cable is too long (maximum of 15 feet between devices).</li> <li>• The IEEE 1394 device uses an incompatible protocol and will not be discovered</li> </ul>
47.	Cannot record to or from the IEEE 1394 device, including Dub recordings.	<ul style="list-style-type: none"> <li>• To initiate a recording to IEEE 1394 device press the REC key. The Record menu displays allowing setup of the recording.</li> <li>• The source device for the recording is not powered on.</li> <li>• When dubbing, the destination device for the recording is not powered on.</li> <li>• The wrong media, (analog tape for digital recording, or digital tape for the analog recording) is in the device.</li> <li>• Either the program is copy protected, or if there are multiple subchannels and one of the programs (not necessarily the program requested) is copy protected.</li> <li>• The program has already been recorded once and the copy protection only allows one recording.</li> <li>• Unapproved source device for copy protected material.</li> <li>• The recording device can not decode the copyright signal included in the signal source (try another device if available).</li> <li>• The playing device (for dubbing) does not support copyrighted material.</li> <li>• Source for recording is copyrighted.</li> <li>• Too many IEEE 1394 devices in network. Insufficient bandwidth available. Disconnect unused devices.</li> <li>• Source Device has higher speed (S 400) than record device. If possible, reverse devices, play in the slower device and record in the faster device.</li> </ul>
48.	Cannot control the IEEE 1394 device from the Transport Menu.	<ul style="list-style-type: none"> <li>• Device may not support the command.</li> <li>• Selected function is gray (such as Record for a DVD, which does not support the Record function).</li> </ul>
49.	When ChannelView™ list is displayed, information appears incomplete	<ul style="list-style-type: none"> <li>• Available information is sent from the broadcaster or cable provider. No other data is available.</li> </ul>
50.	Program to be recorded was correctly selected from ChannelView, however, incorrect program was recorded.	<ul style="list-style-type: none"> <li>• The broadcaster supplied program information that was incorrect and/or was changed after a recording was added to the Record List.</li> </ul>
51.	Incomplete ChannelView program recorded.	<ul style="list-style-type: none"> <li>• Recording device may have lack of space availability and there is not enough blank space to make a full recording.</li> </ul>



# Troubleshooting, continued

Problem	Possible Solution
52. ChannelView program recording failed.	<ul style="list-style-type: none"> <li>• Connection and compatibility issues with IEEE 1394 (FireWire®) digital devices. This may include too many Firewire devices in use at one time, or the recording device not understanding the record command.</li> <li>• Television lost power long enough to lose current clock time.</li> <li>• Analog VCR power was left Off.</li> </ul>
53. TV is not responding, after pulling out a Memory card during playback.	<ul style="list-style-type: none"> <li>• Press STOP or wait until playback is complete before removing media card.</li> </ul>
54. TV can't play or stop a media card.	<ul style="list-style-type: none"> <li>• NetCommand was not set up. Without NetCommand enabled, you can only use ENTER to play and CANCEL on the TV remote to control the media cards.</li> </ul>
55. Can't see a thumbnail picture in the JPEG menu, or can't see a track/song name in the Playlist menu.	<ul style="list-style-type: none"> <li>• File does not meet file standards for playback.</li> </ul>
56. The message "Lamp will soon exceed..." keeps displaying after the lamp has been replaced.	<ul style="list-style-type: none"> <li>• Unplug the AC cord, then plug in. When you next power on the TV the message, "Did you replace the lamp? Press ENTER for Yes, press CANCEL for No" will appear. Press ENTER and the "Lamp will soon exceed.." message will no longer appear.</li> </ul>
57. TV PAUSE does not start when the PAUSE key is pressed.	<ul style="list-style-type: none"> <li>• If there is a full screen pause without a slider appearing, then TV Pause is off. Go to the Setup menu and change the TV Pause setting from Off to Always or On Request. Press Pause.</li> <li>• TV Pause needs to be restarted. Press DEVICE to display the Device Selection menu and press ENTER. Press Pause.</li> <li>• Power off then on the TV. Press Pause.</li> <li>• Can't use TV Pause while recording an analog program.</li> <li>• See Reset Menu instructions below.</li> <li>• TV is connected to Component-1 or 2, Input-DTV or PC. Change the connection to a different input (see page 11).</li> </ul>
58. See on screen message "TV Disc is full..."	<ul style="list-style-type: none"> <li>• Some recording(s) on the Track List need to be deleted. Press DEVICE to display the Device Selection menu, then select TV Disc. Press GUIDE to display the track list. Highlight program(s) to delete and press CANCEL twice to confirm.</li> </ul>

## Using The System Reset Button

If the TV doesn't respond to either the remote control or the front panel controls or will not power off, press the SYSTEM RESET button on the front panel with a pointed item such as the point of a ball point pen or end tip of a paperclip.

The TV will turn off and the green led will flash quickly for about one minute. When the green led stops flashing, you may turn on the TV again. The changes you made while the TV was most recently on, before you used the SYSTEM RESET button may be lost, however, the changes you made previously are not lost. Only those changes since the last power On may be lost when the system reset button is pressed. All other settings are retained.

## Using the Reset Menu for Reset of the TV or TV Disc

Press TV menu followed by 1,2,3 to see the RESET SERVICE MENU to reset the TV or TV Disc.

**Read on screen warnings before proceeding, as some user data or settings may be erased.**

Your choices are:

1. Reset System Defaults (**CAUTION:** All settings, except V-Chip, will be reset to the original factory defaults).

**or**

2. Reset TV Disc (Track List will not be affected).
3. Erase TV Disc (**CAUTION:** Track List will be cleared).
4. Reformat TV Disc (**CAUTION:** Track List will be cleared).

# Additional Information

## Demo Mode

This TV has a demo mode for use in a retail store. To turn On/Off, press the following buttons in sequence:

MENU, 0, QV, 0

LICENSOR'S SUPPLIERS DO NOT MAKE OR PASS ON TO END USER OR ANY OTHER THIRD PARTY, ANY EXPRESS, IMPLIED OR STATUTORY WARRANTY OR REPRESENTATION ON BEHALF OF SUCH SUPPLIERS, INCLUDING, BUT NOT LIMITED TO THE IMPLIED WARRANTIES OF NON-INFRINGEMENT, TITLE, MERCHANTABILITY OR FITNESS FOR A PARTICULAR PURPOSE.

This product incorporates copyright protection technology that is protected by U.S. patents and other intellectual property rights. Use of this copyright protection technology must be authorized by Macrovision, and is intended for home and other limited pay-per-view uses only unless otherwise authorized by Macrovision. Reverse engineering or disassembly prohibited.

CableCARD™ is a trademark of Cable Television Laboratories, Inc.

HDMI™ the HDMI logo and High-Definition Multimedia Interface are trademarks or registered trademarks of HDMI Licensing LLC.

Manufactured under license from Dolby Laboratories. Dolby® and the double-D symbol are registered trademarks of Dolby Laboratories.

Lifestyle® 28 is a trademark of the Bose Corporation.

XBox™ is a trademark of the Microsoft Corporation.

Playstation® 2 is a trademark of the Sony Corporation.

This product includes technology owned by Microsoft Corporation and cannot be used or distributed without a license from Microsoft Licensing, Inc.

MultiMediaCard™ is trademark of Infineon Technologies and licensed to the MultiMediaCard Association.

SmartMedia™ is a trademark of Toshiba Corp.

CompactFlash® and CF are trademarks of the CompactFlash Association.

MEMORY STICK™ is a trademark of Sony Corp.

DTV LINK™ Certification Logo is a trademark of the Consumer Electronics Association.

DCR™ Certification Logo is a trademark of the Consumer Electronics Association.

Firewire® is a trademark of Apple Computer, Inc. registered in the U.S. and other countries.

Digital Light Processing™ and DLP™ are trademarks of Texas Instruments.

MonitorLink™, NetCommand®, ViewPoint®, QuickView™, SuperQuickView™, Diamond Shield™, PerfectColor™, MediaCommand™, ChannelView™ and Definedge™ are trademarks of Mitsubishi Digital Electronics America, Inc.

### **IMPORTANT**

**Do not attempt to update the software of this TV with software or cards that are not provided by or authorized by Mitsubishi Digital Electronics America, Inc. Non-authorized software may damage the TV and will not be covered by the warranty.**

# Index

## A

### A/V

- Disc Search 58
- Memory Reset 76
- Receiver, add 41-43
- Reset 12
- Setting Descriptions 77-78
  - Audio 77
  - Video 78

### Add

- A/V Receiver 41-43
- Devices 44-47

### Audio Setting

- Analog and Digital 7 7
- Analog only 77
- Digital only 77

### Antenna 14

- Menu 64, 68

### AudioVideo Menu 64, 76

## B

### Back Panel Inputs 14-15

### Black Enhancement 76

### Bypassing the V-Chip Lock 87

## C

### CableCARD™ 14

- Inserting 19
- Technology 20

### Captions Menu 64, 71-72

### Change Device 48

### Channel 68, 70

- Memorize 68
- Name 68

### ChannelView 55

### Cleaning and Service 96

### Color Balance, Setting 65

### Connecting

- A/V Receiver 24
- Cable Box 19
- Component 1, and 2 Inputs with YPbPr 14, 25, 26
- Computer with a PC Monitor Output 25
- Digital Audio Output 15
- DTV Receiver with
  - Component Video 26
  - RGB, HV Video 27
- DVD Player with Component Video 25
- DVI Device with Analog Audio 15, 28
- External Devices & NetCommand 18
- Helpful Hints 32
- HDMI Device 15, 28
- IEEE 1394 Devices 15, 30-31

### Lead Antenna 21

### NetCommand® IR Emitter 29

### RS-232C 15, 28

### S-Video 24

### Satellite Receiver 24

### Separate UHF and VHF Antenna 21

### Stereo System 24

### Wall Outlet Cable 19

### Copy-Protected Material 59

### Current Recordings, cancelling 57

## D

### Daylight Savings Time, setting 70

### Device

#### Add 44-47

#### Advanced Learn Screen 46

#### Change 48

#### Connection for, Screen 46

#### Control with Net Command® 85

#### Delete 48

##### IEEE 1394 55

#### IR Controlled 55

#### Learn Screen 45

#### Menu 54

#### Name Screen 46

#### Screen 45

#### Device Setup 39

### Device Menu Button to Display Menus 54

### Device Selection Menu 53, 55

### Diamond Shield™ Removal 97

### Digital

#### Audio 77

##### Output 15

#### Default Record Device 67

#### Prefer, Setting 68

### Display Formats 82-84

### DTV

#### Connectors and Adaptors 26

#### Link (see also IEEE 1394) 15

### DVD Format Definitions 82

### DVI Analog Audio 15, 28

## F

### Filter Cleaning 98

### Finish Screen 40, 43, 48, 52

### Front Button Lock 73

### Front Control Pane Indicators 12

## G

### GUIDE Button 55

## H

### HDMI 15, 28

## I

Icon Order, Viewing, Changing 67

IEEE1394

- Adding Automatically 51-52
- and NetCommand® Control 50
- Compatible Devices 30
- Device Type Screen 52
- Input/Output 13, 15
- Name 51

Important Safeguards 6-7

Indicators, front panel 12

Information Displays, On-Screen 94

Input DTV 14, 47

IR Emitter-NetCommand® 15, 29

## J

JPEG Picture Thumbnail Menu 61

## L

Lamp

- Cartridge Replacement 99-100
- Indicator 12

Language selection 39, 65, 77

## M

M(onitor)-Link 15, 28

Media Cards 13

- Front Control Panel 13
- Playback 61-62
- Slots 13, 61

Memorize Channels 68

Monitor Output 14, 22, 23, 43

MP3 Playlist Menu 62

## N

NetCommand® 11

- Edit NetCommand Screen 42-48
- Information Screen 39
- Initial Setup 39-40
- Menu 64, 67
- On Screen Buttons 37
- Peer-to-Peer Connections 57
- Setting up Recordings 56
- Specialized Device Keys 95
- Time-Delayed Recording 56

## P

PC 15, 25, 60, 84

PerfectColor™ (Manual Color Balance ) 65

PIP

- Device Selection Menu 53
- Operation 79

## R

Record List 57

Record To

Menu 55

Setup 56

Remote Control

Buttons 35, 36

Care 36

Functions 35-36

with NetCommand® 34

Operation 36

Programming Codes 91-93

Transport Buttons 67

Reset Color 65

Review Screen 40

RF Connection for Cable Screen 47

## S

Setting the Clock 70

Setup Menu 64, 65-66

Sleep Timer 36

Software version 66

Specifications 89-90

Status Indicator, front panel 12

SQV (SuperQuickView™) 69

System Reset Button 12, 105

## T

Time Menu 64, 70

Time Zone Selection 70

Timer

Indicator 12

On/Off setting 70

Track List Screen 58

Transport Menu 67

Troubleshooting 101-105

TV Accessories 10

TV Disc 11

Archiving 58

TV Pause 65-66

TV Speakers 76

## V

V-Chip Lock Menu 64, 73-75

Exceptions 75

Passcode 73, 74, 87

Ratings Guideline 75

VCR

Connecting 22, 23

Recording 59

Restrictions for Traditional 59

Video Mute 76

Video Settings 78

## W

Welcome Screen 39

WMA7 Playlist Menu 62

# MITSUBISHI TV SOFTWARE

## END-USER LICENSE AGREEMENT FOR EMBEDDED SOFTWARE

**IMPORTANT – READ CAREFULLY:** This License Agreement is a legal agreement between you (either an individual or an entity) and Mitsubishi Digital Electronics America, Inc. (MDEA) for all software pre installed and/or provided along with this television (“Software”). By utilizing this television and Software, you agree to be bound by the terms of this License Agreement.

The Software is protected by United States copyright laws and international treaty provisions, as well as other intellectual property laws and treaties. The Software is licensed, not sold.

1. **LICENSE GRANT.** MDEA grants you a non-exclusive, non-transferable, limited right and license to use one copy of the Software only with the Mitsubishi television model that included this owner’s guide and owned by you.

2. **RIGHTS AND LIMITATIONS.**

Software Not for Resale. You may not resell or otherwise transfer for value the Software, except in conjunction with a sale of the TV that Software has been pre installed.

Prohibition on Reverse Engineering, Decompilation and Disassembly. The Software contains trade secrets or other proprietary material in its human perceivable form and to protect them, you may not reverse engineer, decompile, or disassemble, or otherwise reduce the Software to any human perceivable form, except to the extent that the foregoing restriction is expressly prohibited by applicable law.

Separation of Components. The Software is licensed as a single product. Its component parts may not be separated for use on more than one TV.

No Rental. You may not rent, lease, lend, or sublicense the Software.

Trademarks. This License Agreement does not grant you any rights to any trademarks of MDEA.

3. **VIOLATIONS.** You understand that any use, copying or transfer of the Software, except as permitted pursuant to this License, may subject you to serious criminal and civil penalties including damages and an award to MDEA of attorneys’ fees in connection with any violation of this License. You further understand that you may be held legally responsible for any copyright infringement or other violation of intellectual property rights that is caused, encouraged, or induced by your failure to abide by the terms of the License. This license is effective until terminated, and will terminate immediately without notice from MDEA or judicial resolution if you fail to comply with any provision of this License.

4. **COPYRIGHT.** All title and intellectual property rights in and to the Software (including but not limited to any images, photographs, animations, video, audio, music, text, and “applets” incorporated into the Software), and any accompanying printed materials are owned by or licensed to MDEA. All title and intellectual property rights in and to the content which may be accessed through use of the Software is the property of the respective content owner and may be protected by applicable copyright or other intellectual property laws and treaties. This License Agreement grants you no rights to use such content, except that you own the media on which the Software is recorded, but MDEA and its licensors retain ownership of the Software itself. All rights not expressly granted are reserved by MDEA.

5. **EXPORT RESTRICTIONS.** MDEA is licensing the Software for use within the United States. You agree that you will not export or re-export the Software. You specifically agree not to export or re-export the Software: (i) to any country to which the U.S. has embargoed or restricted the export of goods or services, which currently include, but are not necessarily limited to Cuba, Iran, Iraq, Libya, North Korea, Sudan, and Syria, or to any national of any such country, wherever located, who intends to transmit or transport the Software back to such country; (ii) to any person or entity who you know or have reason to know will utilize the Software in the design, development, or production of nuclear, chemical, or biological weapons; or (iii) to any person or entity who has been prohibited from participating in U.S. export transactions by any federal agency of the U.S. government. You warrant and represent that neither the BXA nor any other U.S. federal agency has suspended, revoked, or denied your export privileges.

6. **DISCLAIMER OF WARRANTY. EXCEPT AS OTHERWISE PROVIDED IN THIS LICENSE OR IN THE LIMITED WARRANTY APPLICABLE TO THE TV, MDEA MAKES NO OTHER WARRANTIES OF ANY KIND WHATSOEVER REGARDING THE SOFTWARE AND HEREBY EXPRESSLY DISCLAIMS ALL WARRANTIES OF ANY KIND WHATSOEVER, EXPRESS OR IMPLIED, WITH RESPECT TO THE SOFTWARE. ALL IMPLIED WARRANTIES, INCLUDING, WITHOUT LIMITATION, THE IMPLIED WARRANTIES OF MERCHANTABILITY AND FITNESS FOR A PARTICULAR PURPOSE ARE HEREBY EXPRESSLY DISCLAIMED BY MDEA. IN NO EVENT SHALL MDEA BE LIABLE TO YOU OR ANY THIRD PARTIES, IN CONTRACT, IN TORT OR OTHERWISE, FOR ANY DIRECT, INDIRECT, SPECIAL, INCIDENTAL OR CONSEQUENTIAL DAMAGES OF ANY KIND OR NATURE. BECAUSE SOME JURISDICTIONS DO NOT ALLOW THE EXCLUSION OR LIMITATION OF IMPLIED WARRANTIES, THE ABOVE LIMITATION MAY NOT APPLY TO YOU.**

7. **LIMITATION OF LIABILITY. MDEA SHALL NOT, UNDER ANY CIRCUMSTANCES BE LIABLE TO YOU OR ANY THIRD PARTIES FOR ANY DAMAGES OF ANY NATURE, WHETHER INDIRECT, SPECIAL, INCIDENTAL, CONSEQUENTIAL OR OTHERWISE, INCLUDING, BUT NOT LIMITED TO, ANY CLAIMS FOR LOST PROFITS, LOSS OF GOOD WILL OR EXPENDITURES MADE OR COMMITTED FOR IN RELIANCE ON THE CONTINUATION OF THIS LICENSE. YOU AGREE THAT NEITHER MDEA’S BREACH OF THIS LICENSE NOR ITS FAILURE TO REPAIR A DEFECT, ERROR OR BUG SHALL CONSTITUTE A FAILURE OF THE ESSENTIAL PURPOSE OF THIS LICENSE. BECAUSE SOME JURISDICTIONS DO NOT ALLOW THE EXCLUSION OR LIMITATION OF LIABILITY FOR CONSEQUENTIAL OR INCIDENTAL DAMAGES, THE ABOVE LIMITATIONS MAY NOT APPLY TO YOU. MDEA’s liability to you for direct damages for any cause whatsoever and regardless of the form of the action, will be limited to the money paid by you for the TV (based on fair market value of the TV) that caused the damages.**

8. **GENERAL.** This License Agreement will be governed by the laws of the State of California.

# Mitsubishi DLP™ Projection Television Limited Warranty

MITSUBISHI DIGITAL ELECTRONICS AMERICA, INC. (“MDEA”) warrants as follows to the original purchaser of this television that if purchased from an authorized MITSUBISHI Audio/Video Dealer, should it prove defective by reason of against defects arising from improper workmanship and/or material:

**a. Parts.** The lenticular (i.e. front picture) screen and/or the Diamond Shield™ is warranted against defects in materials and workmanship for a period of thirty (30) days from the date of the original purchase at retail.. The VIP lamp and all other parts (except any software incorporated into this television) are warranted for a period of one (1) year from the date of the original purchase at retail. We will repair or replace, at our option, any defective part without charge for the part. Parts used for replacement may be replaced with those of like kind and quality and may be new or remanufactured. Parts used for replacement are warranted for the remainder of the original warranty period.

**b. Embedded Software.** MDEA warrants that all software incorporated into this television set (the “Embedded Software”) will perform in accordance with the functional description of Embedded Software in all material respects, but MDEA does not warrant that the Embedded Software is error-free. MDEA also does not warrant that the Embedded Software will be compatible under IEEE 1394 AV/C and HAVi software standards with products produced by any other manufacturer. The warranty contained in this section shall continue for a period of one (1) year from the date of the original purchase at retail.. If, after prompt notice within the warranty period, MDEA determines that the Embedded Software has failed to perform in accordance with such functional description in all material respects and if such failure is not due to accident, misuse, modification or misapplication of the Embedded Software, then MDEA shall modify or replace the nonconforming Embedded Software at no charge to you, which at MDEA’s sole discretion may be fulfilled by means of modification or replacement software contained on a replacement media card for Customer installation. The foregoing shall be MDEA’s sole obligation to you under this limited warranty. All rights under this limited warranty on the Embedded Software also subject to your compliance with the terms of the Software License Agreement applicable to this television, and this limited warranty on the Embedded Software shall be null and void if the Embedded Software is modified or changed in any manner except as specifically authorized by MDEA.

**c. Labor.** For thirty (30) days after the original purchase at retail, we will repair or replace, at our option, the lenticular screen if it proves defective. For certain items that are designed to be replaced by the consumer, including (but not limited to) the Diamond Shield™ and/or some Embedded Software, the consumer is solely responsible for any replacement labor. The VIP lamp is consumer replaceable and labor for replacement is not covered under warranty, please refer to the Owner’s Guide for replacement procedures. Air filter cleaning is normal consumer required maintenance and labor for this procedure is not covered under warranty, please refer to the Owner’s Guide for air filter cleaning procedures. For all other parts, we will provide the labor for a warranty repair by an authorized MITSUBISHI service center without charge for one (1) year from the original date of purchase at retail.

**d. Notice.** To obtain warranty service, you must notify an authorized MITSUBISHI service center of any defect within the applicable warranty time period.

e. This DLP™ Projection Television uses a revolutionary technology, Digital Micromirror Device™, to create the screen image. This technology creates the image using small dots, or picture elements (pixels). Your DLP Projection TV is manufactured to a high level of performance and quality, in fact, 99.99% perfect in the number of properly functioning pixels. As in other display technology, sometimes a pixel is continuously active, inactive or the incorrect color. Our standard is clear; MDEA warrants only that the percentage of properly functioning pixels will be not less than 99.99% of all pixels.

**BEFORE REQUESTING SERVICE, please review the instruction booklet to insure proper installation and correct customer control adjustment. If the problem persists please arrange for warranty service.**

## 1. TO OBTAIN WARRANTY SERVICE:

a. Contact your nearest authorized MITSUBISHI service center whose name and address can be obtained from your MITSUBISHI dealer, by writing at the address provided below, calling MDEA at the 800-332-2119, or use the support feature of our website at [www.mitsubishi-tv.com](http://www.mitsubishi-tv.com).

b. Warranty service will be provided in your home or, if required, at an authorized service shop, provided that your television is located within the geographic territory customarily covered by an authorized MITSUBISHI service center. If not, you must either deliver your television to an authorized service location at your own expense, or pay for any travel and/or transportation costs the service center may charge to and from your home. Actual service labor will be provided without charge.

c. Proof of purchase date from an authorized MITSUBISHI dealer is required when requesting warranty service. Present your sales receipt or other document which establishes proof and date of purchase. THE RETURN OF THE OWNER REGISTRATION CARD IS NOT A CONDITION OF WARRANTY COVERAGE. However, please return the Owner Registration Card so that we can contact you should a question of safety arise which could affect you.

d. To obtain a replacement VIP lamp during the warranty period, please contact the MDEA Consumer Relations Department at (949) 830-8364. After the warranty period you may order the lamp directly from the MDEA Parts Department at (800) 553-7278.

## 2. THIS WARRANTY DOES NOT COVER:

a. Up to .01% pixel outages (small dot picture elements that are dark or incorrectly illuminated).

b. Damage to Diamond Shield, lenticular screen or Fresnel lens, screen frame, cosmetic damage or to any other damage where such damage is caused by unauthorized modification, alteration, repairs to or service of the product by anyone other than an authorized MITSUBISHI service center; physical abuse to or misuse of the product (including any failure to carry out any maintenance as described in the Owner's Guide including air filter cleaning or any product damaged by excessive physical or electrical stress); any products that have had a serial number or any part thereof altered, defaced or removed; product use in any manner contrary to the Owner's Guide; freight damage; or any damage caused by acts of God or other factors beyond the reasonable control of MDEA, such as power surge damage caused by electrical system or lightning. This warranty also excludes service calls where no defect in the product covered under this warranty is found, service calls related to unsatisfactory audio or visual reception or signal unless caused a defect in the product that is covered under this warranty, all costs, expenses or any other damages arising from product installation, or set-ups, any adjustments of user controls (including contrast, brightness, color, tint, fine tuning, sharpness), other adjustment necessary to prepare the unit for display or use, connection with any external audio receiver, antenna, cable or satellite systems, or service of products purchased or serviced outside the U.S.A. Please consult the operating instructions contained in the Owner's Guide furnished with the product for information regarding user controls.

3. ANY EXPRESS WARRANTY NOT PROVIDED HEREIN, AND ANY REMEDY WHICH, BUT FOR THIS PROVISION, MIGHT ARISE BY IMPLICATION OR OPERATION OF LAW, IS HEREBY EXCLUDED AND DISCLAIMED. THE IMPLIED WARRANTIES OF MERCHANTABILITY AND OF FITNESS FOR ANY PARTICULAR PURPOSE ARE EXPRESSLY LIMITED TO A TERM OF ONE YEAR.

4. UNDER NO CIRCUMSTANCES SHALL MDEA BE LIABLE TO PURCHASER OR ANY OTHER PERSON FOR ANY INCIDENTAL, SPECIAL OR CONSEQUENTIAL DAMAGES, WHETHER ARISING OUT OF BREACH OF WARRANTY, BREACH OF CONTRACT, OR OTHERWISE.

5. Some states do not allow limitations on how long an implied warranty lasts, or the exclusion or limitation of incidental, special, or consequential damages, so the above limitations or exclusions may not apply to you.

6. This warranty gives you specific legal rights, and you may also have other rights which vary from state to state.

In no event shall Mitsubishi have any liability, including without limitation, for general, consequential, incidental, or special damages for loss, destruction, damage or corruption of recorded data, media or software resulting from use of this television, or cost of recovery of lost data, media or software therefore.

## **MITSUBISHI DIGITAL ELECTRONICS AMERICA, INC.**

9351 Jeronimo Road

Irvine, CA 92618-1904

**WARNING:** This product contains chemicals known to the State of California to cause cancer and/or birth defects or other reproductive harm.



**Website:**

[www.mitsubishi-tv.com](http://www.mitsubishi-tv.com)

**Email:**

[MDEAservice@mdea.com](mailto:MDEAservice@mdea.com)

**To order replacement or  
additional remote controls,  
lamp cartridges or Owner's  
Guides, call  
800-553-7278**

**For questions, call Consumer  
Relations at  
800-332-2119**